

PSC Ferencak



katalog rezervnih dijelova

2015/16

SVI PUTOVI VODE U PSC FERENČAK

www.psc-ferencak.hr

Šifra kupca

--	--	--	--	--	--



PSC Ferencak

Poštovani klijenti,

Pred Vama stoji novi katalog proizvoda koje možete naći u poljoprivredno-servisnim centrima Ferencak. Ova tvrtka je osnovana 1988. godine u prostorijama obiteljske kuće u Križevcima i s vremenom se razvijala, pa tako danas ima pet centara i to u Križevcima, Koprivnici, Bjelovaru, Virovitici i Osijeku. U centrima se nudi najnovija moderna oprema za poljoprivredna gospodarstva, od strojeva, rezervnih dijelova, repromaterijala i sjemenske robe. U ovom katalogu je naveden veći dio asortimana koji je potreban svakom poljoprivrednom gospodarstvu. Proširena je traktorska ponuda, ali i sva druga mehanizacija, a tako i potrošni materijal. Sav najnoviji asortiman iz naše ponude možete pronaći i naručiti na našoj web stranici www.psc-ferencak.hr, a putem elektronske pošte na adresu info@psc-ferencak.hr možete uputiti narudžbu ili upit na koji će Vam tijekom dana odgovoriti naši radnici. Svi potrebni dijelovi se naručuju u roku 48 sati, a Vama se isporučuju putem pošte ili izravnom dostavom. Obrasci za narudžbe se nalaze na kraju kataloga, ali i na web stranicama tvrtke. Mi smo Vam uvijek na raspolaganju i pomažemo Vam savjetima u najkraćem mogućem roku. Nadam se da ćemo i dalje uspješno surađivati, te da će Vam naša pomoć u svakom trenutku biti od velike koristi.



Želim Vam puno uspjeha u razvoju Vašeg gospodarstva!

Direktor PSC Ferencak
Drago Ferencak



Potražite naše centralno skladište u Križevcima

KRIŽEVCI

uprava, centralno skladište, veleprodaja i maloprodaja

Nikole Tesle 12

KONTAKT

tel. +385 (48) 681 900 (uprava)

tel. +385 (48) 681 902 (prodavaonica)

fax. +385 (48) 682 903

e-mail: info@psc-ferencak.hr

WEB: www.psc-ferencak.hr



RADNO VRIJEME

Ljetno: 1.3. - 30.10.	07-19 pon-pet
	07-14 sub
Zimsko: 1.11. - 28.2.	07-17 pon-pet
	07-13 sub

Vaš predstavnik



Posjetite nas i u našim poslovnicama

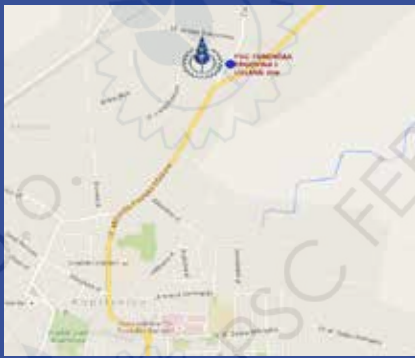

PSC Ferenčak Koprivnica

Otvoreno 1998. godine.
Adresa: Čarda 6, 48000 Koprivnica
tel.: +385 (48) 647 902
fax: +385 (48) 647 902
Radno vrijeme:
"Ljetno" 07-19 pon-pet, 07-14 sub
"Zimsko" 07-17 pon-pet, 07-13 sub



PSC Ferenčak Osijek

Otvoreno 2004. godine.
Adresa: Livana, Omladinska 128 31000 Osijek
tel.: +385 (31) 211 902
fax: +385 (31) 211 902
Radno vrijeme:
"Ljetno" 07-16 pon-pet, 07-14 sub
"Zimsko" 07-15 pon-pet, 07-13 sub



PSC Ferenčak Bjelovar

Otvoreno 2008. godine.
Adresa: Gudovečka cesta 25 43000 Bjelovar
tel.: +385 (43) 235 902
fax: +385 (43) 235 902
Radno vrijeme:
"Ljetno" 07-19 pon-pet, 07-14 sub
"Zimsko" 07-17 pon-pet, 07-13 sub



PSC Ferenčak Virovitica

Otvoreno 2014. godine.
Adresa: Poduzetnička zona II/12 33000 Virovitica
tel.: +385 (33) 728 902
fax: +385 (33) 728 902
Radno vrijeme:
"Ljetno" 07-19 pon-pet, 07-14 sub
"Zimsko" - 07-17 pon-pet, 07-13 sub



PREUZMITE KATALOG I U DIGITALNOJ VERZIJI NA NAŠOJ INTERNETSKOJ STRANICI I BUDITE U TOKU SA STALNIM PROŠIRENJEM ASORTIMANA POMOĆU QR KODA ILI NA WEB-u
www.psc-ferencak.hr



Posjetite našu WEB trgovinu na adresi: www.psc-ferencak.hr

1.korak

Ukucajte u adresnu liniju internetskog preglednika
www.psc-ferencak.hr

ili

1.korak

Ukucajte u okvir internetskog preglednika (npr. Google)
PSC FERENČAK i odaberite poveznicu
PSC Ferencak

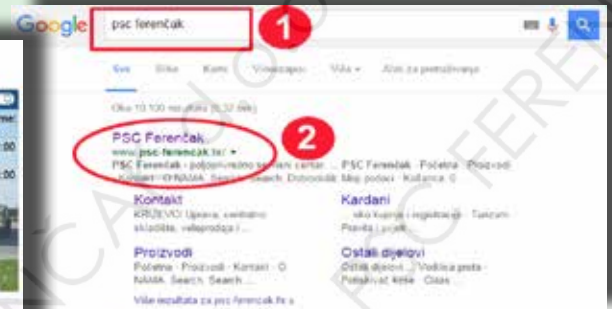

2.korak

U izborniku odaberete kategoriju proizvoda (npr. OBRADA ZEMLJE, a zatim PLUGOVI)



3.korak

Odaberite proizvođača



4.korak Odaberite traženi dio (npr. RAONICI)

Proučite detalje (odabir DETALJI)



5.korak Odaberite tip koji vam odgovara



Pošaljite upit



Odaberite Leave a message



Upišite svoje ime i e-mail adresu na koju želite odgovor,

Upišite tekst upita

Naručite proizvod u 4 koraka

1.korak
Proučiti detalje i
odabrati
U košaricu

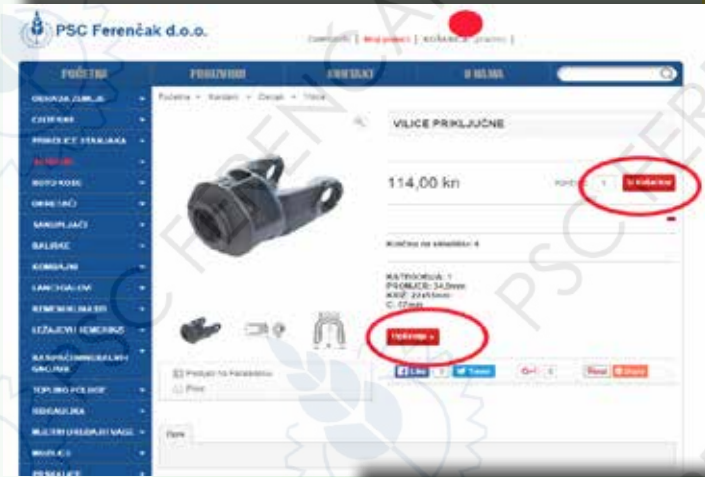

Za upite o proizvodu
koristite
KOD proizvoda

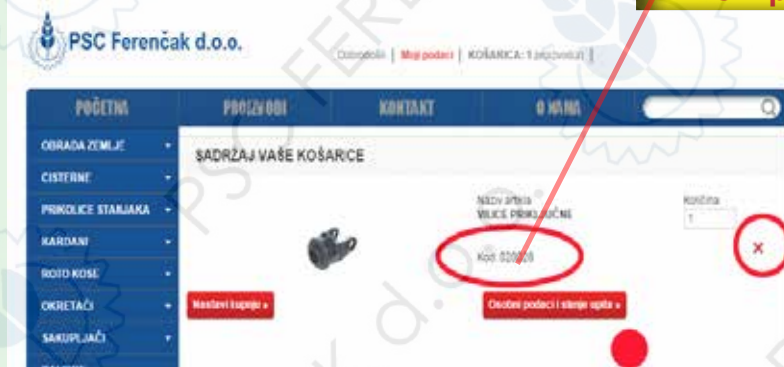

2.korak
Provjeriti sadržaj
košarice. Suvišne
dijelove ukloniti
klikom na **X**

3.korak
Logirajte se
ili odaberite
**NEREGISTRIRANI
KORISNICI**

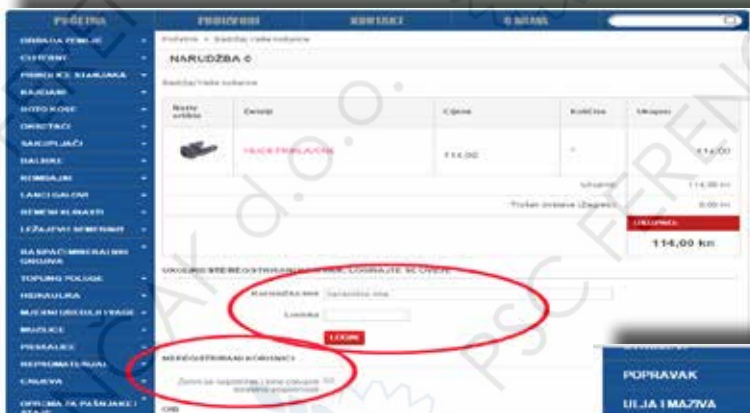

4.korak
Popunite polja
označena *, način
plaćanja i dostavu.
Odaberite
PRIHVATI





U našim poljoprivredno-servisnim centrima možete potražiti širok asortiman rezervnih dijelova za sve vrste poljoprivrednih strojeva i priključaka, a također možete naručiti i kupiti nove pogonske i radne strojeve. Osim toga, vršimo usluge popravaka i servisiranja kardana i pumpi prskalica, kao i izradu visokotlačnih hidrauličkih crijeva po mjeri.





SADRŽAJ

STRANA

OBRADA ZEMLJE	1 Dijelovi za plugove	9-28
	2 Dijelovi za rotodrljače	31-41
	3 Noževi za freze	43-47
	4 Dijelovi za malčere	49-55
	5 Dijelovi za grubere, podrivače i tanjurače	57-69
	6 Dijelovi za sijačice	71-79
PRIHRANA I ZAŠTITA BILJA	7 Dijelovi za cisterne	81-99
	8 Rasipači mineralnih gnojiva	101-109
	9 Dijelovi za prikolice stajnjaka	111-115
	10 Dijelovi za prskalice	117-137
ZELENA LINIJA	11 Dijelovi za roto kose	139-149
	12 Dijelovi za okretače	151-157
	13 Dijelovi za sakupljače	159-165
	14 Dijelovi za preše	167-177
ŽETVA	15 Dijelovi za kombajne	179-195
TRANSMISIJA	16 Remeni i gusjenice	197-205
	17 Lanci	207-217
	18 Kardani i dijelovi za kardane	219-247
	19 Ležajevi	249-257
TRAKTORSKI PROGRAM	20 Traktorski dijelovi	259-307
REPRO-MATERIJAL	21 Repromaterijal	309-315
PAŠNJAK I STAJA	22 Oprema za pašnjake i staje	317-325
IGRAČKE	23 Igračke	327-332
	Narudžbenica i evidencije gospodarstva	333-338





Strana

DIJELOVI ZA PLUGOVE

Eberhardt	11
Gassner	11
Gregoire Besson	11
Heger	11
Krone	11-12
Kuhn	12
Kverneland	13
Lemken	13-15
Niemeyer	15
Overum	15
Pöetinger/Landsberg	16-17
Rabewerk	17-18
Regent	18-19
Vogel & Noot	19-23
IMT - OLT	24
Vijci za plugove	25
Ostali vijci	26-28



1

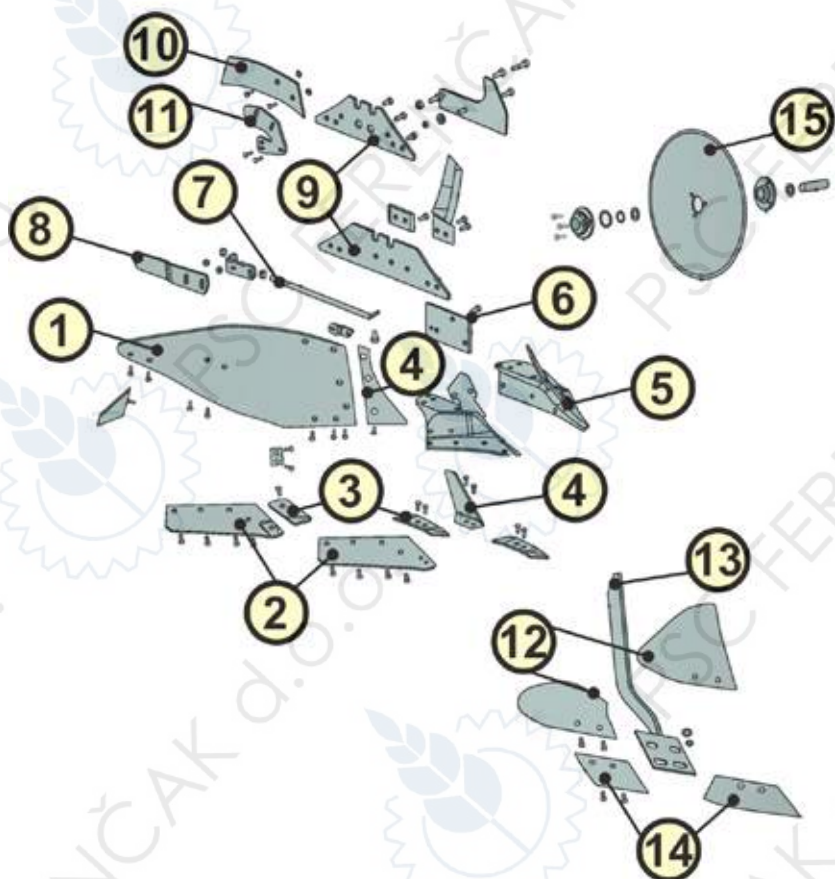

- ① Daska pluga
- ② Raonik
- ③ Špica raonika
- ④ Prsa daske
- ⑤ Plužna glava
- ⑥ Peta pluga
- ⑦ Upornik daske
- ⑧ Produžetak daske
- ⑨ Plaz
- ⑩ Pero
- ⑪ Nosač pera
- ⑫ Daska pretplužnjaka
- ⑬ Nosač pretplužnjaka
- ⑭ Raonik pretplužnjaka
- ⑮ Disk crtala





EBERHARDT

ŠIFRA	NAZIV	KAT.BR.	
192929	Raonik D	S54554, S54564, S54560	
192928	Raonik L	S54555, S54565, S54561	
192417	Raonik D	306196, 306130	
199895	Raonik L	306195, 306129	
201006	Raonik D	306194, 302488	
201007	Raonik L	306193, 302487	
192418	Špica raonika D	302490	
199896	Špica raonika L	302491	
192932	Plaz kratki D	110210	
199897	Plaz kratki L	110211	
192931	Plaz dugi D	110222	
199898	Plaz dugi L	110223	
192528	Plaz D/L	301162	
199899	Daska duga D	STB 50000	
199900	Daska duga L	STB 50001	
192630	Daska duga D	304582	
192631	Daska duga L	304583	
199901	Prsa daske D	STB 40000 STB 40004	
199902	Prsa daske L	STB 40001 STB 40005	
195681	Raonik pretplužnjaka D	S22602	
195682	Raonik pretplužnjaka L	S22603	

GASSNER

196356	Raonik D	SS1080-3	
196357	Raonik L	SS1090-3	
199440	Raonik D	SS1080	
199905	Raonik L	SS1090	

GASSNER

ŠIFRA	NAZIV	KAT.BR.	
196693	Raonik D	MSS11386	
196694	Raonik L	MSS11386	
200164	Raonik D	MRSS1580	
200165	Raonik L	MRSS1590	
196355	Daska pluga D	HST1080 HST2080	
196354	Daska pluga L	HST1090 HST2090	
192368	Prsa daske D	VST1080 VST2080	
193363	Prsa daske L	VST1090 VST2090	
199906	Raonik pretplužnjaka D	11834	
197580	Raonik pretplužnjaka D	11835	

GREGOIRE BESSON

199687	Raonik D	173614	
199688	Raonik L	173613	
200492	Raonik D	173424	
200491	Raonik L	173423	
200494	Špica raonika D	173322	
200191	Špica raonika L	173331	
199685	Daska pluga D	173404 173480	
199686	Daska pluga L	173403 173479	

HEGER

191985	Raonik D	9HYWR	
199907	Raonik L	9HYWL	

KRONE

192745	Raonik D	9690070 9290070 KG12SSR	
199908	Raonik L	9690070 9290070 KG12SSR	
199911	Raonik D	9690290 KG14-16RSS	
199912	Raonik L	9691290 KG14-16RSS	



1

KRONE

ŠIFRA	NAZIV	KAT.BR.	
199633	Plaz kratki D	1231621 1241620	
199634	Plaz kratki L	1231631 1241630	
202134	Plaz kratki D	1231603	
202145	Plaz kratki L	1231610	
199635	Plaz dugi D	1231643 1241640	
199636	Plaz dugi L	1231653 1241650	
199632	Predplaz D	1231663 1241660	
199913	Predplaz L	1231124 1241121	
199631	Daska pluga D	9592090	
199914	Daska pluga L	9593090	
200946	Daska pluga D	959210.0	
200947	Daska pluga L	959310.0	
193956	Prsa daske D	9594050	
199915	Prsa daske L	9594250	
192418	Prsa daske D	9594150	
199896	Prsa daske L	9594350	

KUHN

149929	Raonik 16° D	622136 622212	
149930	Raonik 16° L	622137 622213	
192665	Raonik 14° D	622134	
199887	Raonik 14° L	622135	
194927	Špica raonika D	622128	
194928	Špica raonika L	622129	
199527	Plaz dugi D / L	761108	
200084	Plaz dugi D	278076	
200085	Plaz dugi L	278077	

KUHN

ŠIFRA	NAZIV	KAT.BR.	
199530	Plaz D / L	761108	
200082	Plaz kratki D	278074	
200083	Plaz kratki L	278075	
196815	Plaz kratki D	279138	
196817	Plaz kratki L	279139	
199383	Daska pluga D	616190	
199916	Daska pluga L	616191	
199531	Prsa daske D	619060	
199917	Prsa daske L	619061	
200699	Prsa daske D	619038	
200700	Prsa daske L	619039	
200701	Prsa daske D	619172	
200702	Prsa daske L	619173	
203383	Prsa daske D	619200	
203384	Prsa daske L	619201	
199918	Pero daske I. D	617100	
140001	Pero daske I. L	617101	
140002	Pero daske II. D	617102	
140003	Pero daske II. L	617103	
140004	Pero daske III. D	617104	
140005	Pero daske III. L	617105	
140006	Pero daske IV. D	617106	
140007	Pero daske IV. L	617107	
199384	Pero daske D	648102	
199919	Pero daske L	648103	
199526	Raonik predplužnjaka D	631106	
199920	Raonik predplužnjaka L	631107	
199528	Raonik predplužnjaka D	631100	
199922	Raonik predplužnjaka L	631101	
199683	Daska predplužnjaka D	619132	
192577	Daska predplužnjaka L	619133	



KVERNELAND

ŠIFRA	NAZIV	KAT.BR.	
149449	Raonik D	073024	
199924	Raonik L	073025	
199403	Raonik D	053085	
198469	Raonik D	063014 063015	
198470	Raonik L	063016 063017	
198454	Raonik D	073002 073000	
199925	Raonik L	073003 073001	
198465	Raonik D	073004 073024	
198466	Raonik L	073005 073025	
195742	Raonik D	073056	
199926	Raonik L	073057	
199401	Špica raonika D	053090	
199927	Špica raonika L	063090	
199400	Plaz prednji kratki D	063605	
199928	Plaz prednji kratki L	063615	
199400	Plaz dugi D	096603	
199928	Plaz dugi L	063604	
197618	Plaz kratki	063602	
199402	Peta duga D / L	063600	
198485	Peta duga D / L	073609 073604	
198795	Daska pluga D	063261	
199929	Daska pluga L	063271	
200284	Daska pluga D	063283	
200285	Daska pluga L	063293	

KVERNELAND

ŠIFRA	NAZIV	KAT.BR.	
198318	Daska pluga D	073290	
199931	Daska pluga L	073291	
197687	Prsa daske D	063240	
199930	Prsa daske L	063250	
198319	Prsa daske D	073256	
199932	Prsa daske L	073257	
199672	Daska predplužnjaka D	066880	
199933	Daska predplužnjaka L	066881	
198635	Raonik predplužnjaka D	056873	
199634	Raonik predplužnjaka L	066873	
198320	Raonik predplužnjaka D	066868	
199935	Raonik predplužnjaka L	066869	
198455	Nož raonika D	073091	
199936	Nož raonika L	073092	

LEMKEN

198025	Raonik D	3333810	
199937	Raonik L	3333811	
197262	Raonik D	3351958	
199938	Raonik L	3351959	
197402	Raonik D	3352020	
199941	Raonik L	3352021	
199177	Raonik D	3352010	
199541	Raonik L	3352011	
198431	Raonik D	3352120	
199941	Raonik L	3352121	
198330	Raonik D	3352030	
199944	Raonik L	3352031	

**1****LEMKEN**



ŠIFRA	NAZIV	KAT.BR.	
199885	Raonik D	3352134	
199886	Raonik L	3352135	
201943	Raonik D	3351956	
201944	Raonik L	3351957	
200808	Raonik D	3351958	
200809	Raonik L	3351959	
198467	Raonik D	3352130	
198468	Raonik L	3352131	
200869	Raonik D	3333802	
200870	Raonik L	3333803	
203572	Raonik D	3352034	
203571	Raonik L	3352035	
199939	Špica raonika D	3363896	
199940	Špica raonika L	3363987	
192416	Špica raonika D	3364050	
199942	Špica raonika L	3364051	
197263	Špica raonika D	3364150	
199943	Špica raonika L	3364151	
197718	Plaz dugi D / L	3411826	
197620	Plaz kratki	3401570	
198328	Plaz D / L	3411504	
198371	Plaz D / L	3411508	
198329	Predplaz D	3401900	
199945	Predplaz L	3401911	
199673	Peta pluga D	3419312	
199964	Peta pluga L	3419313	

LEMKEN



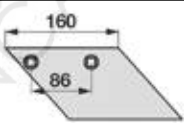
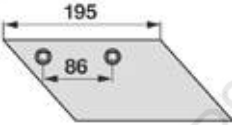
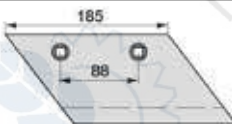
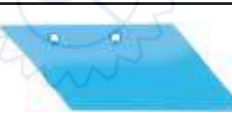
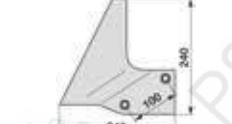
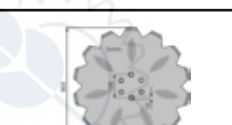

ŠIFRA	NAZIV	KAT.BR.	
140014	Daska pluga D	3441030	
140015	Daska pluga L	3441031	
140010	Daska pluga D	3441034	
140011	Daska pluga L	3441035	
140012	Daska pluga D	3441040	
140013	Daska pluga L	3441041	
197762	Prsa daske D	3451000	
199947	Prsa daske L	3451001	
198447	Prsa daske D	3450524	
199948	Prsa daske L	3450525	
200705	Prsa daske D	3451004	
200706	Prsa daske L	3451005	
140029	Pero daske I. D	3444040	
140030	Pero daske I. L	3444041	
140025	Pero daske II. D	3444030	
140028	Pero daske II. L	3444031	
140019	Pero daske III. D	3444020	
140020	Pero daske III. L	3444021	
140017	Pero daske IV. D	3444010	
140018	Pero daske IV. L	3444011	
197619	Daska predplužnjaka D	3470564	
199949	Daska predplužnjaka L	3470565	
196896	Daska predplužnjaka D	3470600	
199950	Daska predplužnjaka L	3470601	
199399	Daska predplužnjaka D	3470650	
199951	Daska predplužnjaka L	3470651	
198432	Raonik predplužnjaka D	3363710	
199952	Raonik predplužnjaka L	3363711	

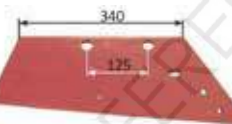
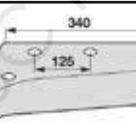
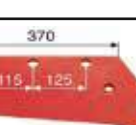
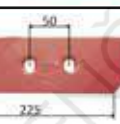

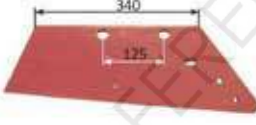
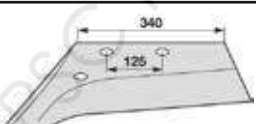
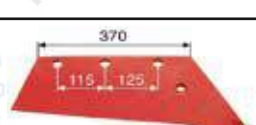
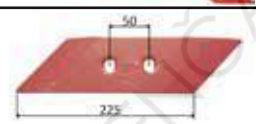
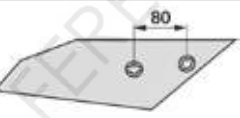

LEMKEN

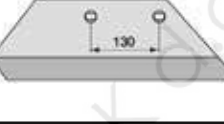
ŠIFRA	NAZIV	KAT.BR.	
196814	Raonik predplužnjaka D	3363712	
199953	Raonik predplužnjaka L	3363713	
197390	Raonik predplužnjaka D	3363720	
199945	Raonik predplužnjaka L	3363721	
197264	Raonik predplužnjaka D	3363714	
199955	Raonik predplužnjaka L	3363715	
202143	Raonik predplužnjaka D	3363722	
202144	Raonik predplužnjaka L	3363723	
198521	Čistač brazde D	3492890	
199956	Čistač brazde L	3492891	
198333	Crtalo pluga	3490042	





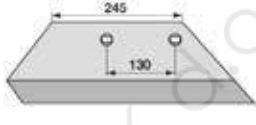



NIEMEYER

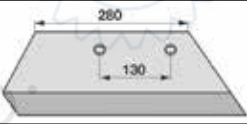

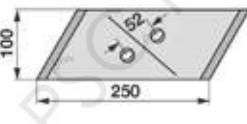
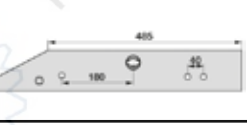
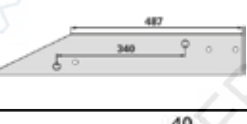
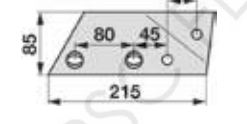

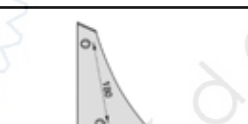
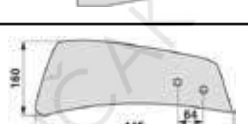
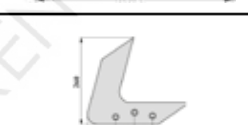
197398	Raonik D	200616	
199957	Raonik L	200617	
191523	Raonik D	200614	
203468	Raonik L	200615	
203664	Raonik D	200814	
203665	Raonik L	200815	
197399	Špica raonika D	NI024104	
199958	Špica raonika L	NI024105	
193263	Špica raonika D	NI200678	
193264	Špica raonika L	NI200679	

OVERUM

200716	Raonik D	165 94600	
200715	Raonik L	195 94601	

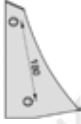
OVERUM

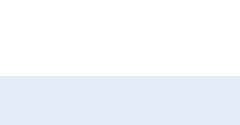
ŠIFRA	NAZIV	KAT.BR.	
202194	Raonik 16°D	165 96090	
202195	Raonik 16°L	165 96091	
201083	Špica raonika D	165 94610	
201082	Špica raonika L	165 94611	
200717	Špica raonika D	165 94608	
200718	Špica raonika L	165 94609	
192593	Plaz D	165 94604	
192594	Plaz L	165 94605	
202048	Plaz D	165 96094	
202049	Plaz L	165 96095	
200731	Plaz prednji D	165 94612	
200730	Plaz prednji L	165 94613	
200714	Daska pluga D	165 94594	
200713	Daska pluga L	165 94595	

200724	Prsa daske D	165 94596	
200725	Prsa daske L	165 94597	
200726	Pero daske D	165 96064	
200727	Pero daske L	165 96065	
200721	Čistač brazde D	165 94622	
200719	Čistač brazde L	165 94623	

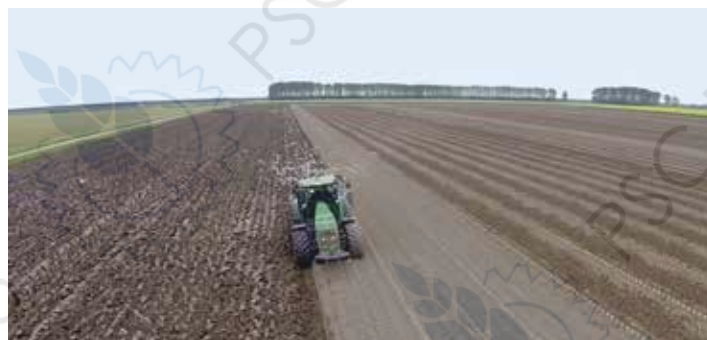

**1****PÖTTINGER /LANDSBERG**

ŠIFRA	NAZIV	KAT.BR.	
196153	Raonik D	000849Z	
196154	Raonik L	000850Z	
199959	Raonik D	006766Z	
199960	Raonik L	006767Z	
199961	Raonik D	1903975	
199962	Raonik L	1903976	
197463	Raonik D	1903944	
197963	Raonik L	1903945	
197314	Raonik D	041327Z	
199964	Raonik L	041328Z	
191770	Raonik D	041317Z	
199965	Raonik L	041318Z	
199682	Raonik D	041319Z	
199557	Raonik L	041320Z	
197547	Raonik D	1903684	
197549	Raonik L	1903685	
199774	Špica raonika D	1903675	
199775	Špica raonika L	1903676	
197550	Špica raonika D	1903682	
197551	Špica raonika L	1903683	
198024	Špica raonika D	041856Z	
202770	Špica raonika L	041857Z	
197270	Plaz prednji D	000813Z	
199969	Plaz prednji L	000814Z	
197064	Plaz stražnji D	000805Z	
199970	Plaz stražnji L	000806Z	
198429	Plaz D / L	041910Z	
201950	Plaz D / L	041911Z	

PÖTTINGER /LANDSBERG

ŠIFRA	NAZIV	KAT.BR.	
194066	Peta pluga D / L	1903850	
199629	Daska pluga D	001763Z	
199971	Daska pluga L	001764Z	
199448	Prsa daske D	001765Z	
199971	Prsa daske L	001766Z	
198380	Prsa daske D	041532Z	
199973	Prsa daske L	041533Z	
196961	Prsa daske D	041884Z	
201852	Prsa daske L	041885Z	
199975	Pero daske I. D	041611A	
199976	Pero daske I. L	041612A	
199579	Pero daske II. D	041613A	
199974	Pero daske II. L	041614A	
199977	Pero daske III. D	041615A	
199978	Pero daske III. L	041616A	
199979	Pero daske IV. D	041617A	
199980	Pero daske IV. L	041618A	
199981	Pero daske I. D	041872B	
199982	Pero daske I. L	041873B	
196937	Pero daske II. D	041874A	
199983	Pero daske II. L	041875A	
194788	Pero daske III. D	041876A	
199984	Pero daske III. L	041877A	
199985	Pero daske IV. D	041878A	
199986	Pero daske IV. L	041879A	
196961	Prsa daske D	041884Z	
201852	Prsa daske L	041885Z	



PÖTTINGER /LANDSBERG

ŠIFRA	NAZIV	KAT.BR.	
199987	Daska predplužnjaka D	001849Z	
196853	Daska predplužnjaka L	001850Z	
199628	Daska predplužnjaka D	921052300	
199988	Daska predplužnjaka L	921062300	
197065	Raonik predplužnjaka D	1903693	
199989	Raonik predplužnjaka L	1903694	
197271	Raonik predplužnjaka D	001847Z	
199990	Raonik predplužnjaka L	001848Z	
197462	Čistač brazde D	929100401	
199991	Čistač brazde L	929100301	

RABEWERK

192858	Raonik D	27081601	
199992	Raonik L	27081602	
197659	Raonik D	27004801	
199993	Raonik L	27004802	
196485	Raonik D	27081801	
199994	Raonik L	27081802	
198551	Raonik D	27513001	
199807	Raonik L	27513002	
193503	Raonik D	27070401	
193504	Raonik L	27070402	
192363	Raonik D	27081701	
199995	Raonik L	27081703	
197211	Raonik D	27082701	
199888	Raonik L	27082702	
203458	Raonik D	27512201	
203459	Raonik L	27512202	

RABEWERK

ŠIFRA	NAZIV	KAT.BR.	
192626	Špica raonika D	27011201	
192627	Špica raonika L	27011202	
197212	Špica raonika D	27082801	
199889	Špica raonika L	27082802	
196761	Špica raonika D	27510901	
196762	Špica raonika L	27510902	
198458	Plaz kratki D / L	27080702	
192576	Plaz kratki D / L	27011500	
198459	Plaz dugi D / L	27080701	
192720	Plaz dugi D / L	27011400	
197552	Daska pluga D	27081301	
199997	Daska pluga L	27081302	
198085	Daska pluga D	27020101	
199999	Daska pluga L	27020102	
196118	Daska pluga D	27010801	
196117	Daska pluga L	27010802	
198636	Prsa daske D	27080601	
199998	Prsa daske L	27080602	
140031	Prsa daske D	27010701	
140033	Prsa daske L	27010702	
199624	Pero daske I. D	27310901	
199625	Pero daske I. L	27310902	
192579	Pero daske II. D	27311001	
192471	Pero daske II. L	27311002	



1

RABEWERK

ŠIFRA	NAZIV	KAT.BR.	
199626	Pero daske III. D	27311101	
199627	Pero daske III. L	27311102	
192472	Pero daske IV. D	27311201	
192470	Pero daske IV. L	27311202	
199382	Pero daske V. D	SRP327PB4	
200000	Pero daske V. L	SRP327PBL4	
192622	Prsa daske D	27040101	
192623	Prsa daske L	27040102	
199551	Pero daske I. D	27280201	
199552	Pero daske I. L	27280202	
198491	Pero daske II. D	27280301	
198457	Pero daske II. L	27280302	
198637	Pero daske III. D	27280401	
191147	Pero daske III. L	27280402	
191179	Pero daske IV. D	27280501	
199647	Pero daske IV. L	27280502	
196484	Raonik predplužnjaka D	27420201	
200001	Raonik predplužnjaka L	27420202	
197213	Raonik predplužnjaka D	27210501	
200002	Raonik predplužnjaka L	27210502	
196851	Raonik predplužnjaka D	27150101	
196852	Raonik predplužnjaka L	27150102	
192647	Raonik predplužnjaka D	27150501	
200003	Raonik predplužnjaka L	27150502	
200004	Pero daske D	27011901	
199343	Pero daske L	27011902	
191185	Disk pluga	72090102	

REGENT

ŠIFRA	NAZIV	KAT.BR.	
197508	Raonik D	DU 28 SR	
200005	Raonik L	DU 28 SL	
199534	Raonik D	DU 29 SR	
200006	Raonik L	DU 29 SL	
196747	Raonik D	DU 433 SR	
196748	Raonik L	DU 433 SL	
191515	Raonik D	DU 440 SR	
191559	Raonik L	DU 440 SL	
198434	Raonik D	SN 640 SR	
200007	Raonik L	SN 640 SL	
199439	Raonik D	DW 35 SR	
200008	Raonik L	DW 35 SL	
100290	Raonik D	DW 40 SR	
100291	Raonik L	DW 40 SL	
191562	Raonik D	DW 440 SR	
191563	Raonik L	DW 440 SL	
199307	Raonik D	DW 445 SR	
199882	Raonik L	DW 445 SL	
200009	Raonik D	DG 774 R	
200010	Raonik L	DG 774 L	
201992	Raonik D	DU 30 SR	
201993	Raonik L	DU 30 SL	
200749	Raonik D	DU 35 SR	
200750	Raonik L	DU 35 SL	
203409	Raonik D	DU 40 SR	
203410	Raonik L	DU 40 SL	



REGENT

ŠIFRA	NAZIV	KAT.BR.	
201035	Raonik D	DU 435 SR	
201036	Raonik L	DU 435 SL	
198091	Špica raonika D	DWS-R	
198092	Špica raonika L	DWS-L	
200697	Špica raonika D	DGS 770 R	
200698	Špica raonika L	DGS 770 L	
199529	Peta pluga	4391011	
200011	Daska pluga D	16225111	
199356	Daska pluga L	16201301	
198433	Prsa daske D	43201171	
200012	Prsa daske L	43201172	
198098	Prsa daske D	22601261	
198094	Prsa daske L	22601262	
200015	Pero daske I. D	57540111	
200016	Pero daske I. L	57540112	
199396	Pero daske II. D	57540121	
200013	Pero daske II. L	57540122	
199397	Pero daske III. D	57540301	
200014	Pero daske III. L	57540302	
200017	Pero daske IV. D	57540311	
200018	Pero daske IV. L	57540312	
197227	Pero daske IV-A D	57642141	
197228	Pero daske IV-A L	57642142	
199597	Raonik predplužnjaka D	3327196	
199891	Raonik predplužnjaka L	3327164	

REGENT

ŠIFRA	NAZIV	KAT.BR.	
191794	Raonik predplužnjaka D	3327260	
191795	Raonik predplužnjaka L	3327292	
197461	Raonik predplužnjaka D	50100031	
199891	Raonik predplužnjaka L	50100032	
199398	Daska predplužnjaka D	51561171	
200019	Daska predplužnjaka L	51561172	
198511	Daska predplužnjaka D	51562131	
198512	Daska predplužnjaka L	51562132	
197918	Plaz prednji D	16501171	
197919	Plaz prednji L	16501172	
192413	Plaz prednji D	49542111	
192414	Plaz prednji L	49542112	
197920	Plaz stražnji D	16502191	
197921	Plaz stražnji L	16502192	

VOGEL & NOOT

198071	Raonik D	PK900001	
200020	Raonik L	PK900002	
198007	Raonik D	P5800101	
200021	Raonik L	P5800201	
197578	Raonik D	CV000014	
200022	Raonik L	CV000015	
196292	Raonik D	P9103001	
196293	Raonik L	P9103101	
193852	Raonik D	PK300101	
196110	Raonik L	PK300201	

**1****VOGEL & NOOT**

ŠIFRA	NAZIV	KAT.BR.	
190902	Raonik D	PK400101	
190903	Raonik L	PK400201	
191512	Raonik D	PK500101	
191153	Raonik L	PK500201	
193851	Raonik D	PK000003	
200023	Raonik L	PK000004	
191514	Raonik D	PK000005	
193736	Raonik L	PK000006	
191749	Raonik D	PK000007	
191750	Raonik L	PK000008	
196750	Raonik D	P9103403	
196751	Raonik L	P9103503	
190898	Raonik D	PK401301	
190899	Raonik L	PK401401	
192628	Raonik D	PK501301	
192629	Raonik L	PK501401	
190906	Raonik D	PK701301	
190907	Raonik L	PK701401	
190908	Špica raonika D	PK801101	
190909	Špica raonika L	PK801102	
191490	Špica raonika D	PK001101	
191830	Špica raonika L	PK001102	
193350	Raonik D	NI024122	
193340	Raonik L	NI024121	
193263	Špica raonika D	NI200678	
193264	Špica raonika L	NI200679	
198496	Raonik D	LK200500A	
198495	Raonik L	LK200600A	

VOGEL & NOOT

ŠIFRA	NAZIV	KAT.BR.	
191446	Plaz dugi D	P8903601	
191447	Plaz dugi L	P8903701	
193857	Plaz D / L	PR703002	
191464	Plaz kratki D	P8903401	
191465	Plaz kratki L	P8903501	
191462	Plaz kratki D	PK803401	
191463	Plaz kratki L	PK803501	
193855	Plaz kratki D / L	PR703003D	
199256	Peta pluga D / L	N1024072	
193857	Peta pluga D / L	PR703001	
191445	Peta pluga D / L	P5800901	
191457	Peta pluga D / L	P5801101	
194091	Špica plaza D / L	N1024004	
199181	Daska pluga D	PK800109	
195708	Daska pluga L	PK800209	
195705	Prsa daske D	PK300103	
195706	Prsa daske L	PK300202	
190672	Daska pluga D	PK300102	
201027	Daska pluga L	PK300202	
193318	Daska pluga D	PK400102	
193272	Daska pluga L	PK400202	



VOGEL & NOOT

ŠIFRA	NAZIV	KAT.BR.	
190831	Prsa daske D	PK400103	
190897	Prsa daske L	PK400203	
191831	Daska pluga D	PK600101	
191832	Daska pluga L	PK600201	
191731	Daska pluga D	PK000101	
191732	Daska pluga L	PK000201	
191438	Prsa daske D	PK000102	
191439	Prsa daske L	PK000202	
192434	Prsa daske D	PK800501	
192433	Prsa daske L	PK800601	
194951	Prsa daske D	N1024080	
194952	Prsa daske L	N1024081	
193846	Daska pluga D	PK700101	
193847	Daska pluga L	PK700201	
191488	Prsa daske D	PK600500	
191498	Prsa daske L	PK600600	
190913	Daska pluga D	PK800101	
190912	Daska pluga L	PK800201	
196844	Pero daske I. D	PR000101	
196845	Pero daske I. L	PR000201	
196846	Pero daske II. D	PR000102	
196847	Pero daske II. L	PR000202	
196290	Pero daske III. D	PR000103	
196291	Pero daske III. L	PR000203	
196848	Pero daske IV. D	PR000104	
196849	Pero daske IV. L	PR000204	

VOGEL & NOOT

ŠIFRA	NAZIV	KAT.BR.	
190896	Prsa daske D	PK400103	
190897	Prsa daske L	PK400203	
192936	Pero daske I. D	PR300101	
193355	Pero daske I. L	PR300201	
194784	Pero daske II. D	PR300102	
194785	Pero daske II. L	PR300202	
193354	Pero daske III. D	PR300103	
192935	Pero daske III. L	PR300203	
194959	Pero daske IV. D	PR300104	
194903	Pero daske IV. L	PR300204	
196370	Pero daske I. D	PR900101K	
196878	Pero daske I. L	PR900201K	
196879	Pero daske II. D	PR900102K	
196373	Pero daske II. L	PR900202K	
200024	Pero daske III. D	PR900103K	
196372	Pero daske III. L	PR900203K	
200025	Pero daske IV. D	PR900104K	
200026	Pero daske IV. L	PR900204K	
192419	Nosač predplužnjaka D	LZ334800	
192421	Nosač predplužnjaka L	LZ334900	
196316	Nosač predplužnjaka D	PG723300	
196326	Nosač predplužnjaka L	PG723400	
190926	Raonik predplužnjaka D	PA305401	
191735	Raonik predplužnjaka D	PA305501	
190927	Raonik predplužnjaka L	PA305501	
191736	Raonik predplužnjaka L	PA305501	
190889	Daska predplužnjaka D	PA305402	
191524	Daska predplužnjaka L	PA305502	
193343	Čistač brazde D	PK201701	
193858	Čistač brazde L	PK201801	

**1****VOGEL & NOOT**

ŠIFRA	NAZIV	KAT.BR.
191729	Čistač brazde D	PK201501
191730	Čistač brazde L	PK201601
194087	Čistač brazde D	N1026240
194088	Čistač brazde L	N1026241
193893	Pero daske D	LZ105102
193840	Pero daske L	LZ105202
191764	Pero pluga KPT	LZ105100
199129	Pero daske rešetkaste D	NI026180
199127	Pero daske rešetkaste L	NI026181
199126	Nosač pera D	NI405190
199128	Nosač pera L	NI405191
194786	Upornik daske kratki	PK400104

VOGEL & NOOT

ŠIFRA	NAZIV	KAT.BR.
191443	Upornik daske dugi	PK800106
194782	Veza daske D	PK300500
194783	Veza daske L	PK300600
190911	Glava plužnog tijela D	PK800300
190910	Glava plužnog tijela L	PK800400
191768	Nosač plužnog tijela	PE400016 PG000022 PG000016 PG000028
191504	Crtalo Ø 500 mm	PP0237E1
191486	Crtalo Ø 600 mm	PP0247E1





VOGEL & NOOT

ŠIFRA	NAZIV	KAT.BR.	
199602	Svornjak visine kotača	PE526801	
193336	Kučište crtala KPT	P8903601	
197457	Kučište crtala KPT	PP023300	
191494	Dihting kućišta crtala	Z2423304	
198498	Osovina crtala	LZ223302	
193859	Nosač crtala dupli	PP023401	
192619	Graničnik crtala	PG023102	
198499	Osovina crtala farmer	LV823401	
195693	Ruka crtala	PP023100	
196346	Ublaživač kotača	Z2441200	
194897	Osovina kotača	LZ128002	
191503	Osovina crtala	PP023302	
198802	Poklopac glavčine kotača	Z234681	
198770	Vijak dubine M24 KPT	LZ528800	

VOGEL & NOOT

ŠIFRA	NAZIV	KAT.BR.	
199598	Vijak za reg. pravca D	LC200006	
193267	Vijak za reg. pravca L	LC200007	
199599	Pero daske I. D	LC400006	
199600	Pero daske I. L	LC400007	
191482	Vijak dubine M22	PG128602	
193342	Vijak za reg. nagiba	PG010500	
198942	Ležaj kućišta crtala	755209	
198920	Ležaj kućišta crtala	752500	
199272	Semering kućišta crtala	791202	
191733	Nosač	PG023103	
190691	Vijak dubine M24	LZ528803	
201026	Čahura podešavanja širine	LC418600	
196216	Držač osovine crtala	LZ334800	
196215	Španer nosača crtala	PP023002	
191496	Poklopac kućišta crtala	PP023202	
197491	Vodilica pluga D / L	PK700102	
191500	Vodilica pluga D	PK800102	
191499	Vodilica pluga L	PK800202	



1

IMT - OLT

ŠIFRA	NAZIV	KAT.BR.	
191052	Raonik 10" - 12" 755	CV006935	
191056	Raonik 14" - 16" 758	CV006937	
191053	Raonik 10" PTO2	CV006939	
101055	Raonik 12" OLT LEOPARD	CF000137	
191054	Raonik 14" - 16"	CV006938	
020039	Disk za plug 460 mm, R=70 mm, 3 rupe		
020058	Disk za plug 510 mm, R=70 mm, 3 rupe		
193362	Disk za plug 460 mm, R=75 mm, 4 rupe	PK401301	
196143	Disk za plug 510 mm, R=75 mm, 4 rupe	PK401401	

IMT - OLT

ŠIFRA	NAZIV	KAT.BR.	
198120	Kučište crtala (staro)		
203889	Kučište crtala (novo)		
191436	Poklopac ležaja crtala		
198919	Ležaj kučišta crtala		
192584	Pero pluga		
197733	Bolcna nosača plugu		
200900	Vijak U M16 za plug		
190776	Crtalo Ø 510 KPL		





VIJCI ZA PLUGOVE

KONUS

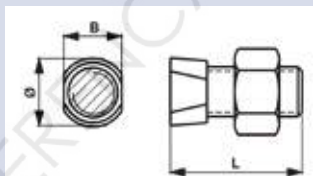

ŠIFRA	M (mm)	L (mm)	K (mm)	B (mm)	Ø (mm)
200729	10	25	7	13,6	15,95

KONUS

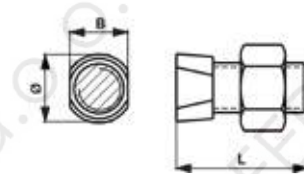

ŠIFRA	M (mm)	L (mm)	K (mm)	B (mm)	Ø (mm)
195467	12	35	8,5	14	18

KONUS

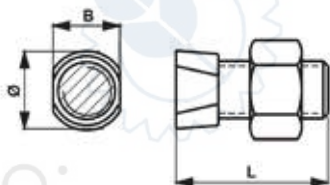

ŠIFRA	M (mm)	L (mm)	K (mm)	B (mm)	Ø (mm)
194069	12	34	7	13,6	15,95
196665	12	40	7	13,6	15,95
191759	12	50	7	13,6	15,95
195746	14	34	7	17	18
190922	16	40	10	19,4	20,8
193271	16	75	10	19,4	20,8

FIRKANT

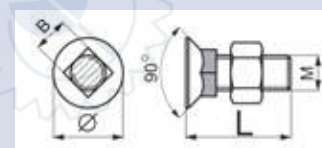

ŠIFRA	M (mm)	L (mm)	K (mm)	B (mm)	Ø (mm)
190893	10	30	8	10	19
198369	12	35	10,5	12	24
200711	12	40	10,5	12	24
200712	12	60	10,5	12	24
193862	12	80	10,5	12	24
198430	12	90	10,5	12	24

FIRKANT

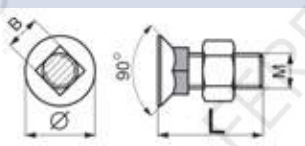

ŠIFRA	M (mm)	L (mm)	K (mm)	B (mm)	Ø (mm)
200720	12	30	7,25	11,3	29,35

2 ZUBA

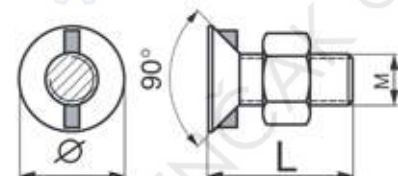

ŠIFRA	M (mm)	L (mm)	K (mm)	B (mm)	Ø (mm)
201215	10	30	4,5	15,1	16
200703	14	35	7	23,1	24

2 ZUBA

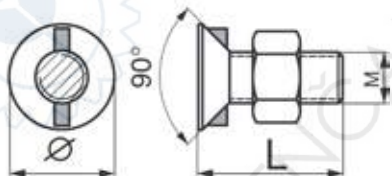

ŠIFRA	M (mm)	L (mm)	K (mm)	B (mm)	Ø (mm)
200831	10	40	6	3,2	19
191456	12	30	7,5	3,6	24
100362	12	35	7,5	3,6	24
194086	12	40	7,5	3,6	24
191667	12	60	7,5	3,6	24
201029	12	85	7,5	3,6	24
190686	14	35	7,5	3,6	24
199622	14	40	7,5	3,6	24

1 ZUB

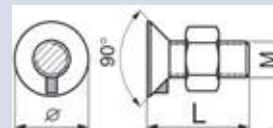

ŠIFRA	M (mm)	L (mm)	K (mm)	B (mm)	Ø (mm)
193860	16	40	10	4,2	32
193861	16	50	10	4,2	32
201028	16	60	10	4,2	32
191552	16	70	10	4,2	32
198870	16	80	10	4,2	32

**DIN 931**

ŠIFRA	KAT. BR.	DIMENZIJE (mm)	KVALITETA
010466		M6x15	8.8
191663	1201620	M6x20	8.8
199161	1007207	M6x28	10.9
204684	1001650	M6x50	10.9
190500	150025500	M8x10	10.9
194820	000208509	M8x16	10.9
192985	30361820	M8x20	10.9
200246	1003845	M8x45	10.9
010495	1003850	M8x50	10.9
204793	18063-855-1	M8x50x1,25	10.9
198284		M10x20	10.9
196019	150393309	M10x20 lijevi	10.9
100244	10111025	M10x25	10.9
200729	523721	M10x25 konus	12.9
193644	VNB1870178	M10x30	8.8
194819	000210701	M10x30	10.9
204294	VN90081870178	M10x30 nazub	10.9
198087	1260196	M10x35	10.9
191652		M10x40	10.9
205150	10031050	M10x50	10.9
202263	10011050	M10x50	8.8
200131	10011060	M10x60	10.9
205667	00905833-DIN961	M12x1,25x25	8.8
200913	00280602	M12x1,25x50	12.9
199503	00240656	M12x1,75x55	10.9
204117	KG00399800	M12x170 INOX	10.9
191456	546000E	M12x30	12.9
204058	KG01840800	M12x35	10.9
191655	10031240	M12x40	10.9
199613	00280543	M12x40x1,75	12.9
204232	510003	M12x45x1,25	12.9
201672	10131250	M12x50	10.9
191669	09310120060	M12x60	8.8
191658		M12x65	8.8
190382		M12x70	10.9
203998	10011290	M12x90	8.8
200669	00530847	M14x90	12.9
203173	100314100	M14x100	10.9
197717	0339393	M14x205 OLT	10.9
190832	10031480	M14x80 INOX	10.9
201000	10011480	M14x80	8.8
194855		M16x35	8.8

ŠIFRA	KAT. BR.	DIMENZIJE (mm)	KVALITETA
193861		M16x50	10.9
205585	93116x07008V	M16x70	10.9
190924	523786V	M16x72 SKT	10.9
199782	10031680	M16x80	10.9
191474	545350E	M16x85	10.9
190747	10031690	M16x90	10.9
204317	100316100	M16x100	10.9
201001	100316120	M16x120	10.9
196872	523764E	M16x125	10.9
198615	0401136	M16x130	10.9
200158	KG00363261	M16x150	8.8
202300	100316160	M16x160	10.9
200157	KG00363561	M16x180	8.8
193339	523769	M16x190	10.9
204214	100316200	M16x200	10.9
202385	1230574M5	M16x220	8.8
194669	VNB2099493	M16x250	8.8
202923	B9901465	M16x330	8.8
194460	C102681	M18x57	8.8
201530	100118100	M18x100	8.8
xxx204299	100320220	M20x220	10.9
196210	600251E	M20x45	8.8
196870	523749E	M20x45	10.9
191777	523798W	M20x55	8.8
191785	580300W	M20x70	8.8
203808	10032070	M20x70	10.9
196868	10032075	M20x75	10.9
202714	10032080	M20x80	10.9
191776	523804W	M20x90	10.9
204746	523853W	M20x100	10.9
199748	100320110	M20x110	10.9
199749	100320130	M20x130	10.9
199596	523754E	20x150	10.9
193849	523754AE	M20x160	8.8
191779	523773W	M20x185	8.8
193850	523778E	M20x200	10.9
193338	523771	M20x215	10.9
196876	523779E	M20x240	10.9
200371	100122200	M22x200	8.8
199605	10112460	M24x60	8.8
204874		M24x75	10.9
196242	523858E	M24x110	10.9
203369		M24x240	8.8
203812	KK077023	M30x72D	10.9
203813	KK077024	M30x72L	10.9
200986	KK071274	M30x84D	10.9
200987	KK071275	M30x84L	10.9



OSTALI VIJCI



DIN 933

ŠIFRA	KAT. BR.	DIMENZIJE (mm)	KVALITETA
191663	1201620	M6x20	8.8
100359		M6x30	8.8
197791		M8x12	8.8
204331		M8x16	8.8
100360		M8x20	8.8
193131		M8x25	8.8
192197		M8x30	8.8
191662		M8x40	8.8
100147	1001845	M8x45	8.8
100146		M8x60	8.8
080047		M10x18	8.8
100361	596200E	M10x20	8.8
198286	9006360	M10x25	8.8
199642	KG00862961	M10x25	8.8
010329		M10x30	8.8
197768	040021163	M10x38	8.8
199455	KG00336061	M10x40	10.9
198097	KG00336261	M10x50	10.9
194821	10111060	M10x60	8.8
193959	10111230	M12x30	8.8
199325	0905059	M12x35	8.8
200373	10111245	M12x45	8.8
201672	10031250	M12x50	10.9
198710		M12x50	8.8
194309		M12x55	10.9
195350	10111260	M12x60	8.8
192718		M14x90 INOX	8.8
196208	598601	M16x30	8.8
196212	601505E	M16x35	8.8
197851	9006740	M16x35	10.9
202336	10121640	M16x40	10.9
199680	KK032760	M16x60	10.9
191783	523782AE	M16x65	10.9
196214	582900E	M16x70VZ	10.9
196213	583010E	M16x90	10.9
204456	10101680	M16x80	8.8
191778	100116180	M16x180	8.8
199750	100320150	M20x150	10.9



DIN 960

Vijak sa šesterokutnom glavom i djelomoičnim FINIM navojem kvalitete 8.8, 10.9 i 12.9

Navoj 1,25

ŠIFRA	KAT. BR.	DIMENZIJE (mm)	KVALITETA
204793	18063-855-1	M8x50x1,25	10.9
205667	00905833-DIN961	M12x25x1,25	8.8
200913	00280602	M12x50x1,25	12.9
204232	510003	M12x45x1,25	12.9

Navoj 1,5

ŠIFRA	KAT. BR.	DIMENZIJE (mm)	KVALITETA
192436		M12x50x1,5	10.9
040479	00280526	M14x50x1,5	12.9
196749	00280531	M16x50x1,5	12.9
196478	00280532	M16x55x1,5	12.9
193891	510018	M16x57x1,5	12.9
040457	00280533	M16x60x1,5	12.9
194781	611600	M16x65x1,5	10.9
205112	126852-25	M16x70x1	10.9
191475	611800E	M16x80x1,5	10.9
200604	00280604	M16x80x1,5	10.9
204411	1031161590	M16x90x1,5	10.9
200688	00530688	M16x90x1,5	10.9
191613	C102682	M18x50x1,5	8.8
191827	00280535	M18x55x1,5	10.9
194867	0242055	M20x55x1,5	10.9
194868	0252065	M20x65x1,5	10.9
190964	580400E	M20x70x1,5	10.9

Navoj 1,75

ŠIFRA	KAT. BR.	DIMENZIJE (mm)	KVALITETA
204604	180631240	M12x40x1,75	8.8
199503	00240656	M12x55x1,75	10.9
199613	00280543	M12x40x1,75	12.9

1 OSTALI VIJCI

IMBUS VIJCI



DIN 912

ŠIFRA	KAT. BR.	DIMENZIJE (mm)	KVALITETA
201690	1151 8 16	M8x16	8.8
100230	0096414701	M10x30	8.8
202962	1150 10 40	M10x40	8.8
201847	1151 12 35	M12x35	8.8

VIJCI S TORBAN GLAVOM



DIN 603

ŠIFRA	KAT. BR.	DIMENZIJE (mm)	KVALITETA
060026	02063	KPL Gramip	8.8
198299	9047121	M6x25	8.8
199283		M6x65 pojilica	8.8
202555	1101840	M8x40	8.8
203880	DA351	M10x25	8.8
203986	603103088	M10x30	8.8
205199	11011030	M10x30 s mat.	8.8

VIJCI ZA NOŽEVE FREZA

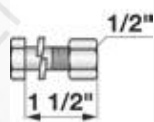

Tip 1

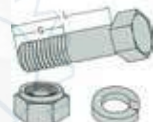

Tip 2

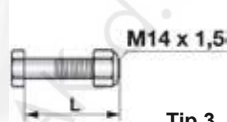

Tip 3

ŠIFRA	KAT. BR.	DIMENZIJE (mm)	Tip	KVALITETA
196040	00270981	Vijak s maticom 1/2"x38 za frezu	1	8.8
204062	1803071635	Vijak s maticom 7/16"x35 UNF	2	12.9
202738	00270993	Vijak noža freze M14x60x1,5	3	12.9
199536	00270977	Vijak noža freze M14x40x1,5	3	12.9

IMBUS VIJCI S UPUŠTENOM GLAVOM



DIN 7991

ŠIFRA	KAT. BR.	DIMENZIJE (mm)	KVALITETA
202262	20897	M8x50	10.9
202980	1163 10 16	M10x16	10.9
202981	1163 10 25	M10x25	10.9
209994	1163 10 30	M10x30	10.9
204522	1161 12 50	M12x50	10.9
202304	1163 16 60	M16x60	10.9
205317	1163 16 90	M16x90	10.9
202305	1163 20 70	M20x70	10.9

VIJAK IMBUS - navojna iglica

Kvaliteta vijka 8.8 i 10.9

DIN 914

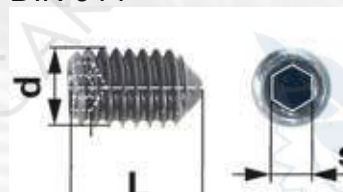

• označava dimenzije navojnih iglica kojima raspolažemo.

L/mm	Promjer d/mm	
	M10	M12
10	•	
12	•	•
16	•	•
20	•	•
25	•	•
30	•	•
45	•	

Svu ostalu vijčanu robu potražite na stranicama naše WEB trgovine na adresi

www.psc-ferencak.hr



Prostor za bilješke



Lined writing area for notes.

PSC ferencak



Dijelove za rotodrljače renomiranih proizvođača potražite u našim poljoprivredno-servisnim centrima u Bjelovaru, Koprivnici, Križevcima, Osijeku i Virovitici ili na WEB-u

www.psc-ferencak.hr

**DIJELOVI ZA ROTODRLJAČE**

ALPEGO, AMAZONE	32
BREVIGLIERI	32
CARRARO, CELLI	32-33
EBERHARDT, EUROMA	33
FALC, FERABOLI	33
FRANDENI	34
HOWARD	34
KRONE, KUHN	34-35
KVERNELAND	35
LELLY, LEMKEN	35-36
MALETTI, MASCHIO	36
MORRA	36
NIEMEYER	36
PEGORARO, PERUGINI, PÖTTINGER	37
RABEWERK, REMAC	37-38
SEIMA, SICMA	38
VOGEL & NOOT	38
ČISTAČ VALJKA	39-40
Uputa za narudžbu	41



ALPEGO

ŠIFRA	NAZIV	KAT.BR.
196522	Nož roto drljače D	36100210
200139	Nož roto drljače L	36100211
195863	Nož roto drljače D	280382
202361	Nož roto drljače L	280383

AMAZONE

194076	Nož roto drljače D	954426
202368	Nož roto drljače L	954427
194075	Nož roto drljače D	6171300
202369	Nož roto drljače L	6170300
201946	Nož roto drljače D	6147300
201947	Nož roto drljače L	6148300

BREVIGLIERI

198331	Klin roto drljače	26085
197824	Klin roto drljače D	32070
200137	Klin roto drljače L	32069

BREVIGLIERI

ŠIFRA	NAZIV	KAT.BR.
040371	Klin roto drljače	
202613	Klin roto drljače	301101
196696	Nož roto drljače D	280440
202370	Nož roto drljače L	280441
199442	Nož roto drljače D	88310
200600	Nož roto drljače L	88311
202621	Nož roto drljače D	401101
202622	Nož roto drljače L	401102
196999	Nož roto drljače D	32710
199731	Nož roto drljače L	32711
199731	Nož roto drljače ravni	
200625	Nož roto drljače D	155216
200626	Nož roto drljače L	155217

CARRARO



CARRARO

ŠIFRA NAZIV KAT.BR.

197597 Klin roto drljače 105479

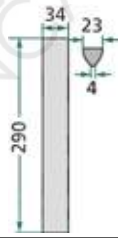

CELLI

198489 Klin roto drljače 301601

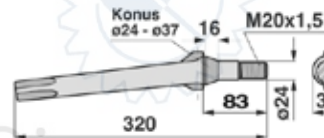

195863 Nož roto drljače D

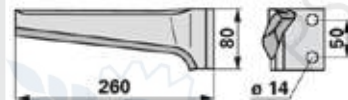

202361 Nož roto drljače L



EBERHARDT

198445 Klin roto drljače D 300334

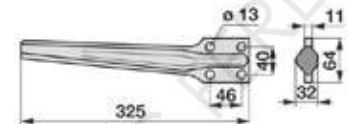

201236 Klin roto drljače L 300333



200793 Klin roto drljače D 300328

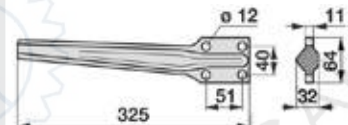

200792 Klin roto drljače L 300327



192731 Nož roto drljače D 302141

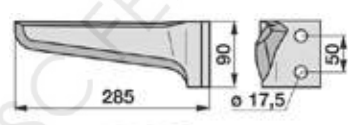

192732 Nož roto drljače L 302142



EUROMA

ŠIFRA NAZIV KAT.BR.

202615 Nož roto drljače D 305701



202616 Nož roto drljače L 305702

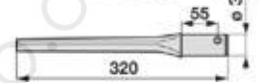

FALC

200068 Nož roto drljače D 512075



200069 Nož roto drljače L 512076



FERABOLI

197720 Klin roto drljače 7A48010

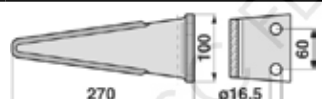

203098 Klin roto drljače 307802

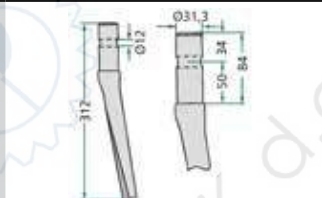

202102 Klin roto drljače 307801

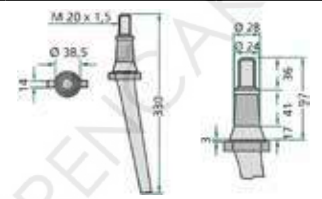

201353 Nož roto drljače 407801

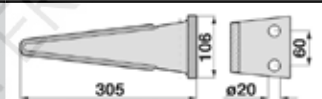

203762 Nož roto drljače 407802

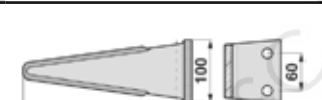



2

ŠIFRA	NAZIV	KAT.BR.
203764	Nož roto drljače	412704
201662	Nož roto drljače	412705
197636	Klin roto drljače	

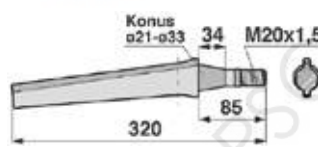
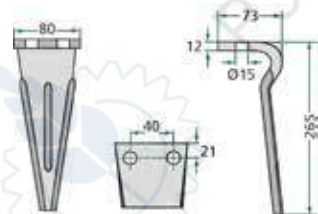
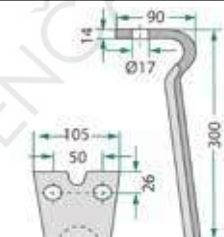

FRANDENI

200226	Nož roto drljače D	9115060001
203362	Nož roto drljače L	9115060002

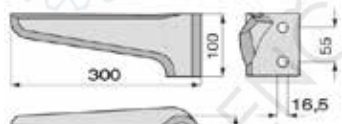

HOWARD

195856	Nož roto drljače D	182936
202371	Nož roto drljače L	182935
201885	Nož roto drljače D	182940
201886	Nož roto drljače L	182939
202733	Nož roto drljače D	185506
202734	Nož roto drljače L	185505

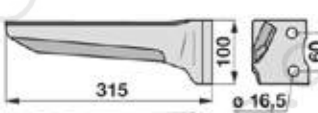
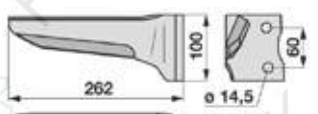

HOWARD

196790	Nož roto drljače D	182938
196791	Nož roto drljače L	182937
040486	Nož roto drljače D	185516 191958 191959
202372	Nož roto drljače L	185515

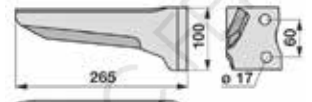
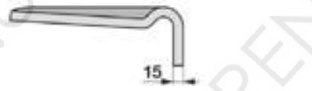
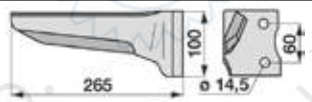

KRONE

199612	Klin roto drljače	303707
200630	Klin roto drljače	303701
200629	Klin roto drljače	303703

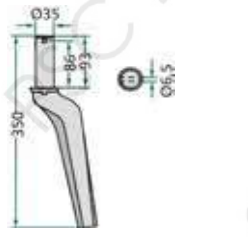
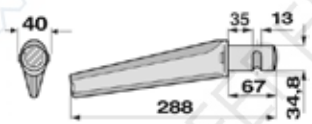

KUHN

196486	Nož roto drljače D	52549400
202375	Nož roto drljače L	52549500
196483	Nož roto drljače ravni	52503700
202373	Nož roto drljače ravni	52510600

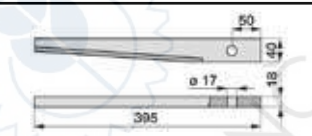
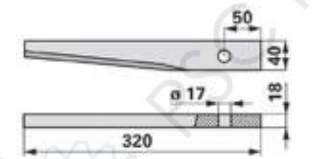
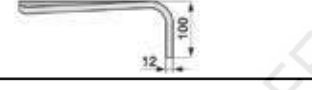
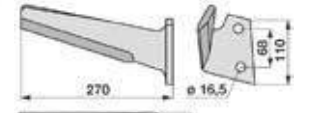



KUHN

ŠIFRA	NAZIV	KAT.BR.	
202608	Nož roto drljače D	K2500100	
202609	Nož roto drljače L	K2500090	
203513	Nož roto drljače D	K25000080	
203514	Nož roto drljače L	K25000070	
202766	Nož roto drljače D	52620400	
202767	Nož roto drljače L	52620500	
196783	Nož roto drljače D	52555410	
196784	Nož roto drljače L	52555510	

KVERNELAND

201255	Nož roto drljače D	44010150	
201256	Nož roto drljače L	44010151	

LELY

ŠIFRA	NAZIV	KAT.BR.	
197063	Klin roto drljače	1160600210	
192831	Klin roto drljače	1169902200	
194310	Klin roto drljače	1169903150	
202617	Klin roto drljače D	1169901120	
202618	Klin roto drljače L	1169901110	
196557	Klin roto drljače	1163214870	
202603	Klin roto drljače D	1169901280	
202604	Klin roto drljače L	1169901270	

2

Sav naš proizvodni program
potražite i naručite preko
naše WEB trgovine
www.psc-ferencak.hr



LEMKEN

ŠIFRA	NAZIV	KAT.BR.	
196677	Nož roto drljače D	377012	
202377	Nož roto drljače L	377013	
196419	Nož roto drljače D	3377022	
196420	Nož roto drljače L	3377023	

MALETTI

196487	Nož roto drljače D	404005	
200631	Nož roto drljače L	404006	

MASCHIO

191727	Nož roto drljače D	404107	
191728	Nož roto drljače L	404108	
192183	Nož roto drljače D	36100215	
202378	Nož roto drljače L	36100216	
192955	Nož roto drljače D	10100262	
200543	Nož roto drljače L	10100226	
194312	Nož roto drljače D	10100262	
194311	Nož roto drljače L	10100263	

MASCHIO

ŠIFRA	NAZIV	KAT.BR.	
200565	Nož roto drljače D	180RHMAS50R	
200566	Nož roto drljače L	180RHMAS50L	
191958	Nož roto drljače D	404111	
191959	Nož roto drljače L	404112	
202489	Nož roto drljače D	36100366	
202488	Nož roto drljače L	36100367	

MORRA

191591	Klin roto drljače D	307702	
200634	Klin roto drljače L	307703	

NIEMEYER

190613	Klin roto drljače D	034000	
200751	Klin roto drljače L	034001	
100317	Nož roto drljače D	34826	
200601	Nož roto drljače L	34825	



PEGORARO

ŠIFRA NAZIV KAT.BR.

196175 Klin roto drljače ravni 105479

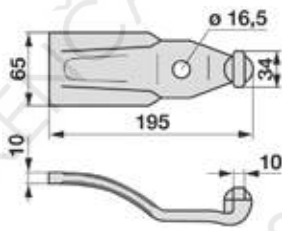

198060 Klin roto drljače ravni 398101

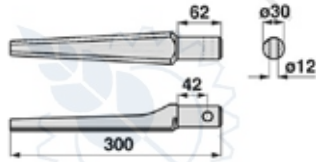

197244 Klin roto drljače ravni 305307

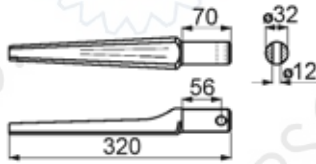

201955 Nož roto drljače D 007869



201956 Nož roto drljače L 087870

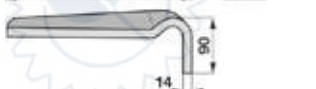

196411 Nož roto drljače D 7862

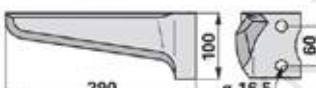

200821 Nož roto drljače L 7863

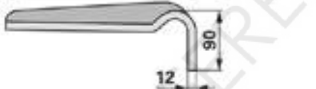

197307 Nož roto drljače 88555



PERUGINI

198788 Klin roto drljače 911262

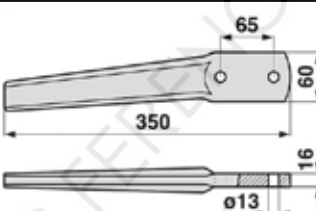

191138 Nož roto drljače D 330402



202379 Nož roto drljače L 330403



PERUGINI

ŠIFRA NAZIV KAT.BR.

200101 Nož roto drljače D KE1205

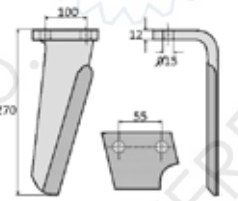

200102 Nož roto drljače L KE1204

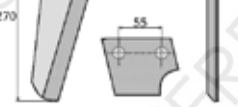

202103 Nož roto drljače D 320424



202104 Nož roto drljače L 320425



POTTINGER

200943 Klin roto drljače RH22

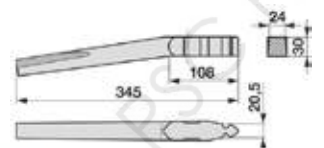

200446 Nož roto drljače D 873430110



200447 Nož roto drljače L 873430120



RABEWERK

202364 Nož roto drljače D 84231801

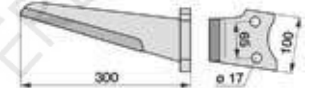

202365 Nož roto drljače L 84231802a

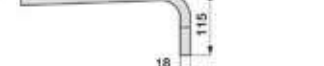

197726 Nož roto drljače D 84091201

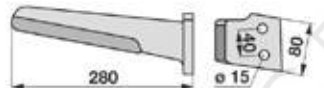

200138 Nož roto drljače L 84091202

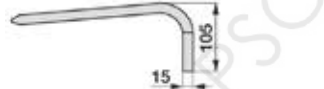

196399 Nož roto drljače D 2901271



200633 Nož roto drljače L 2901270





RABEWERK

ŠIFRA NAZIV KAT.BR.

194103	Nož roto drljače D	84116205	
194104	Nož roto drljače L	84116206	

196696	Nož roto drljače D	EB0177401	
202370	Nož roto drljače L	EB0277401	

REMAC

197761	Klin roto drljače	280301	
--------	-------------------	--------	--

197636	Klin roto drljače	280271	
--------	-------------------	--------	--

SEIMA

200936	Klin roto drljače	RH31	
--------	-------------------	------	--

SICMA

197394	Klin roto drljače	306101	
--------	-------------------	--------	--

198790	Nož roto drljače D	52700	
200179	Nož roto drljače L	52800	

SICMA

197623	Nož roto drljače D	280430	
202382	Nož roto drljače L	280431	
196487	Nož roto drljače D	404005	
200631	Nož roto drljače L	404006	

VOGEL & NOOT

195474	Klin roto drljače	500001	
--------	-------------------	--------	--

196410	Nož roto drljače	280612	
--------	------------------	--------	--

203449	Nož roto drljače D	KZ400003	
203450	Nož roto drljače L	KZ400004	

196646	Nož roto drljače D	987245E	
200448	Nož roto drljače L	987246E	

Potražite nas na WEB-u





ČISTAČ VALJKA

ŠIFRA NAZIV KAT.BR.

198791 Čistač valjka Amazone 250030

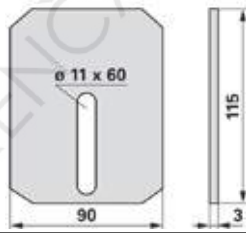

200884 Čistač valjka Amazone 6040200

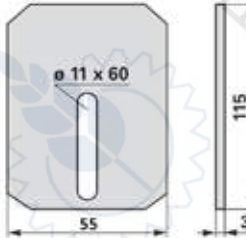

202090 Čistač valjka Breviglieri 3178974

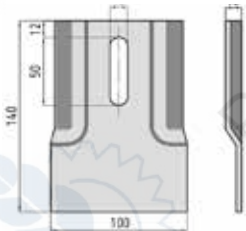

201661 Čistač valjka Breviglieri 801109

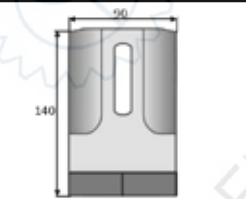

203425 Čistač valjka Eberhardt 300142

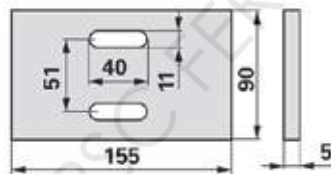

200871 Čistač valjka Feraboli 250152

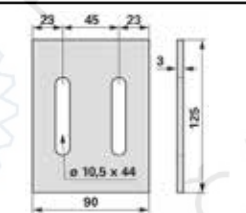

202619 Čistač valjka Feraboli 808501

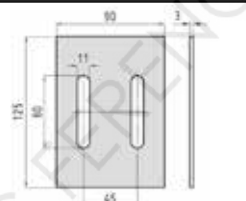

199342 Čistač valjka Kuhn 803802

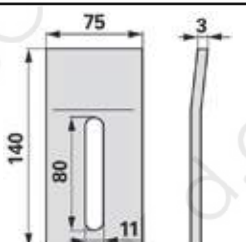

ČISTAČ VALJKA

ŠIFRA NAZIV KAT.BR.

201400 Čistač valjka Kverneland 8008090

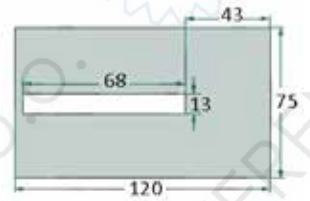

193570 Čistač valjka Lely 250044

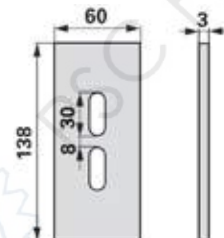

199441 Čistač valjka Lely 250060

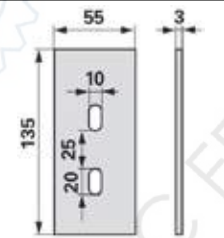

200180 Čistač valjka Lely 250052

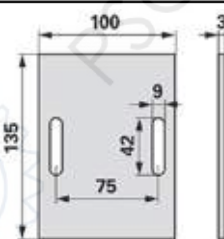

203517 Čistač valjka Lely 250043

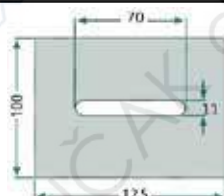

203800 Čistač valjka Lely 250059

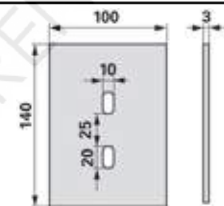

202667 Čistač valjka Maschio 255502

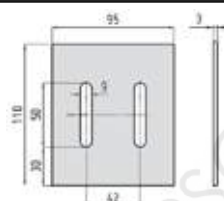

202719 Čistač valjka Maschio 250066

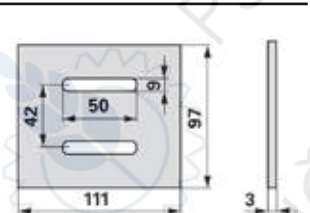



ČISTAČ VALJKA

ŠIFRA NAZIV KAT.BR.

200624 Čistač valjka Maschio 250067

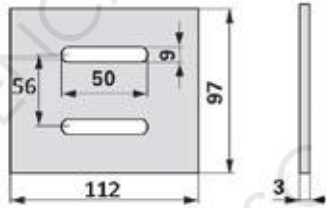

197953 Čistač valjka Rabewerk 250081

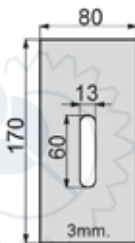

200623 Čistač valjka Rabewerk 840500

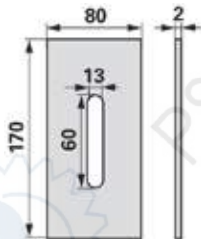

198885 Čistač valjka Rau 250085

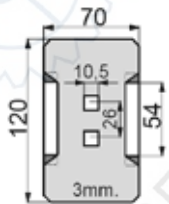

203101 Čistač valjka Standard 807109

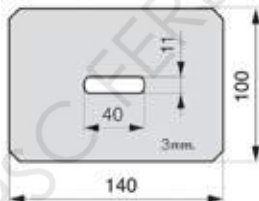

ČISTAČ VALJKA

ŠIFRA NAZIV KAT.BR.

198700 Čistač valjka Vogel & Noot 250158

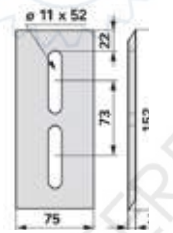

202581 Čistač valjka Vogel & Noot 263001

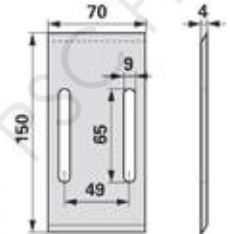

202845 Čistač valjka Vogel & Noot 51M202

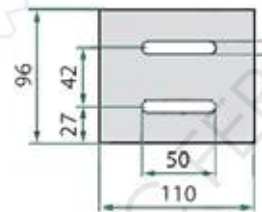

200485 Zaštita noža 10100247

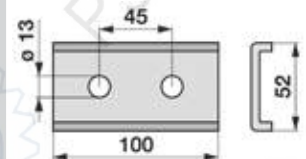

200628 Matica dvojna M16x1,5 88/60 B=60 mm 304107

199621 Matica dvojna M16x1,5 78/50 B=50 mm 304108





Za narudžbu ili upite o specijaliziranim dijelovima pripremite podatke označene na slikama:

2

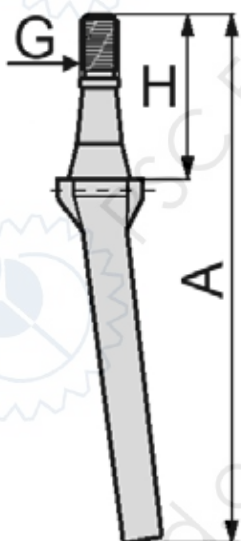

Slika 1

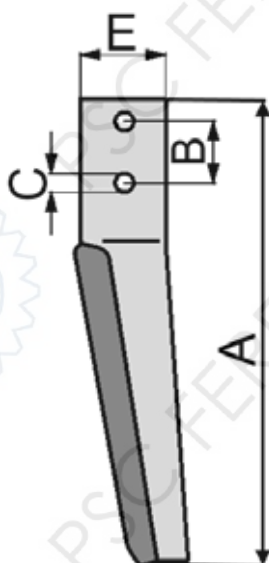

Slika 2

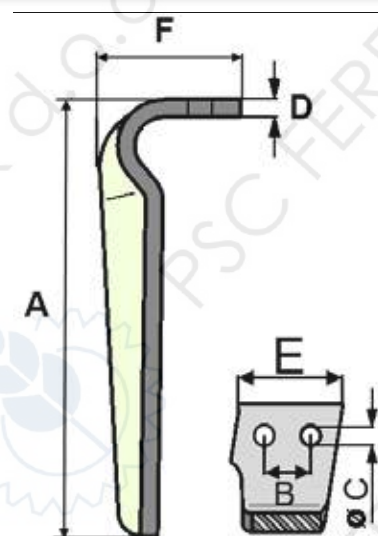

Slika 3

A _____
 B _____
 C _____
 D _____
 E _____
 F _____
 G _____
 H _____
 Proizvođač _____
 Tip _____
 Količina _____
 Slika br. _____

Blank lined area for writing notes or additional information, with a pencil icon in the top right corner.



**NOŽEVI ZA FREZE**

AGRIA	44
BREVIGLIERI	44
CELLI	44
DONDI	44
EBERHARDT	44
HOWARD	44-45
KRONE	45
LABIN, MASCHIO	45
VOGEL&NOOT	45
Upute za narudžbu	46

Noževe za freze, kao i ostale artikle potražite u našim servisnim centrima u Križevcima, Osijeku, Bjelovaru, Virovitici i Koprivnici ili na našim WEB stranicama
www.psc.ferencak.hr



AGRIA

ŠIFRA	NAZIV	KAT.BR.
199644	Nož freze D / L	5043457

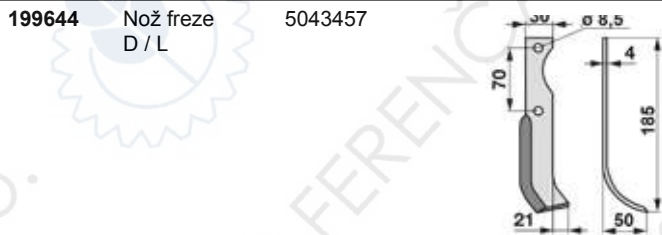

BREVIGLIERI

196792	Nož freze D	11076R
--------	-------------	--------

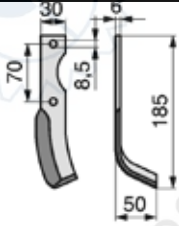

201862	Nož freze L	11076L
--------	-------------	--------

203140	Nož freze D	30329R
--------	-------------	--------

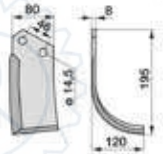

203141	Nož freze L	30329L
--------	-------------	--------

CELLI

199645	Nož freze D / L	422512
--------	-----------------	--------

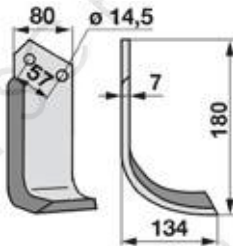

DONDI

202932	Nož freze D / L	271025
--------	-----------------	--------

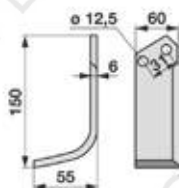

EBERHARDT

ŠIFRA	NAZIV	KAT.BR.
192496	Nož freze D / L	270364

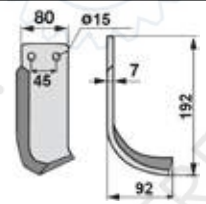

199535	Nož freze D / L	270362
--------	-----------------	--------

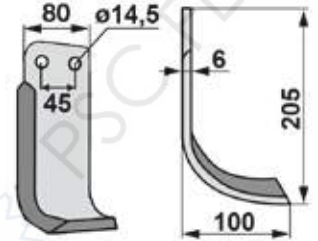

194079	Nož freze D	RKB471-1571
--------	-------------	-------------

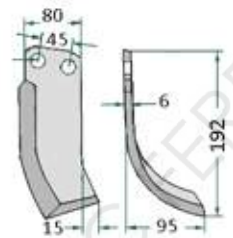

194078	Nož freze L	RKB471-1570
--------	-------------	-------------

HOWARD

196559	Nož freze D	270526
--------	-------------	--------

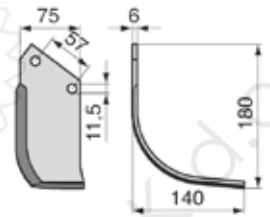

202659	Nož freze L	270527
--------	-------------	--------

199321	Nož freze D	9949-9931
--------	-------------	-----------

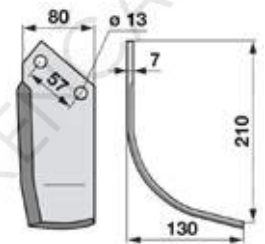

200613	Nož freze L	9948-9930
--------	-------------	-----------

197062	Nož freze D / L	270524
--------	-----------------	--------

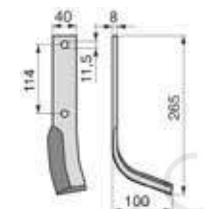

Sve detalje o artiklima saznajte u našim prodajnim centrima ili nas nazovite na broj telefona

048 681 902 (za pozive iz Hrvatske)

(za pozive izvan Hrvatske)

+ 385 48 681 902



HOWARD

ŠIFRA NAZIV KAT.BR.

196184 Nož freze D 626094

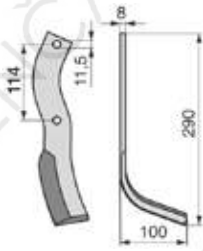

202699 Nož freze L 626093

198642 Nož freze D 624401

200615 Nož freze L 624400

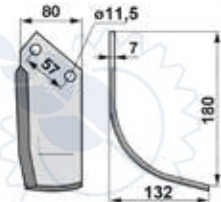

196938 Nož freze D 3901

200614 Nož freze L 3900

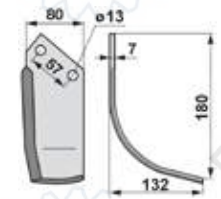

202802 Nož freze D 225010

202803 Nož freze L 225011

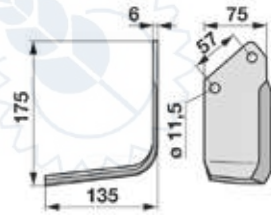

203914 Nož freze D 270888

203915 Nož freze L 270889

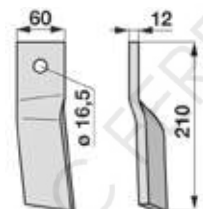

KRONE

191845 Nož freze D / L 270608

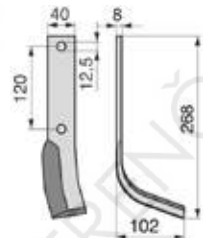

202654 Nož freze D 270604

196409 Nož freze L 270605

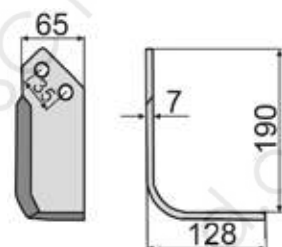

KRONE

ŠIFRA NAZIV KAT.BR.

199646 Nož freze D 270606

203831 Nož freze L 270607

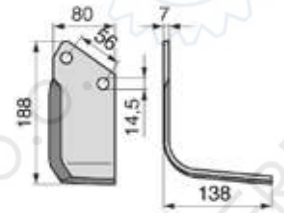

LABIN

100003 Nož freze D 8-10KS 102915

202776 Nož freze L 8-10KS 102916

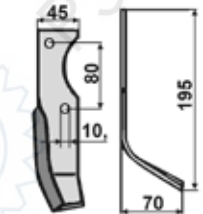

191248 Nož freze D 8-10KS 102913

202775 Nož freze L 8-10KS 102914

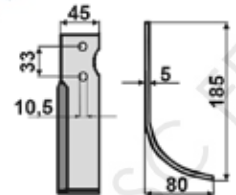

MASCHIO

199649 Nož freze D 270674

202843 Nož freze L 270675

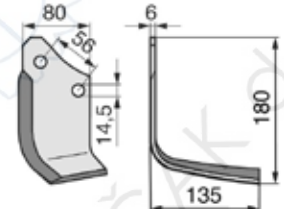

203096 Nož freze D 104143

203097 Nož freze L 104144

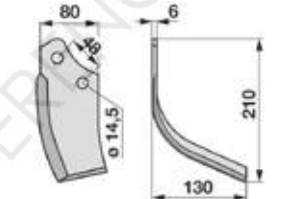

VOGEL & NOOT

199649 Nož freze D 270674

202843 Nož freze L 270675

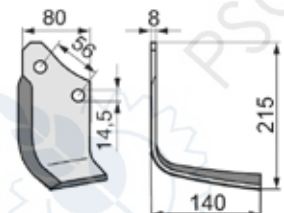



Za narudžbu ili upite o specijaliziranim dijelovima pripremite podatke označene na slikama:

3



Slika 1. Savijeni nož

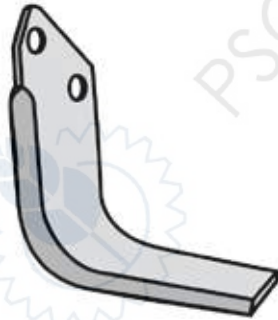

Slika 2. Kutni nož

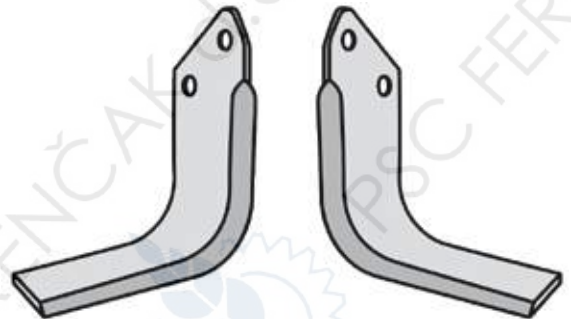

Slika 3. Lijevi nož

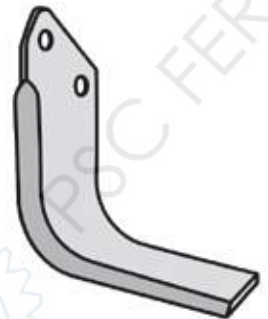

Slika 4. Desni nož

A	_____
B	_____
C	_____
D	_____
E	_____
F	_____
G	_____
Proizvođač	_____
Tip	_____
Količina D	_____
Količina L	_____
Slika br.	_____

**** Vijke za noževe freze pronađite na str. 26-28 (Ostali vijci).**

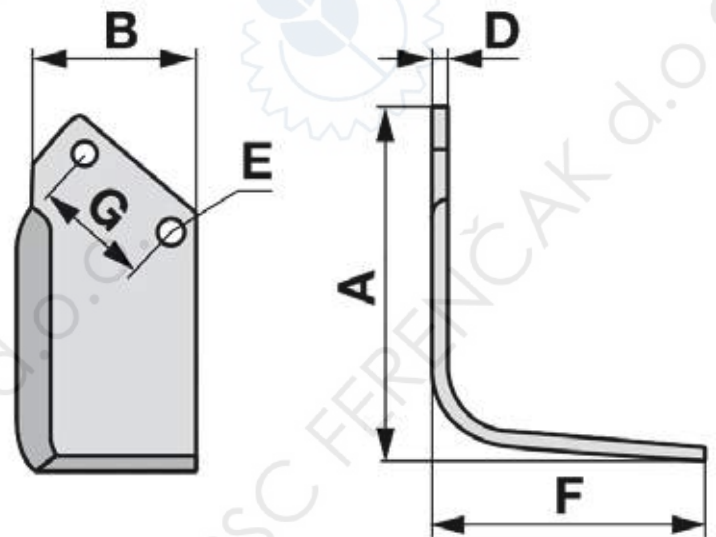

Informirajte se u našim poslovnicama

Križevci	Koprivnica	Osijek	Bjelovar	Virovitica
Nikole Tesle 12	Čarda 6	Livana, Omladinska 128	Gudovečka cesta 25	Poduzetnička zona II/12
48 260 Križevci	48 000 Koprivnica	31 000 Osijek	43 000 Bjelovar	33 000 Virovitica
tel.: 048 681 902	tel.: 048 647 902	tel.: 031 211 902	tel.: 043 235 902	tel.: 033 728 902
fax.: 048 682 903	fax.: 048 647 902	fax.: 031 211 902	fax.: 043 235 902	fax.: 033 728 902

web: www.psc-ferencak.hr

e-mail: info@psc-ferencak.hr



Prostor za bilješke



3

PSC ferencak

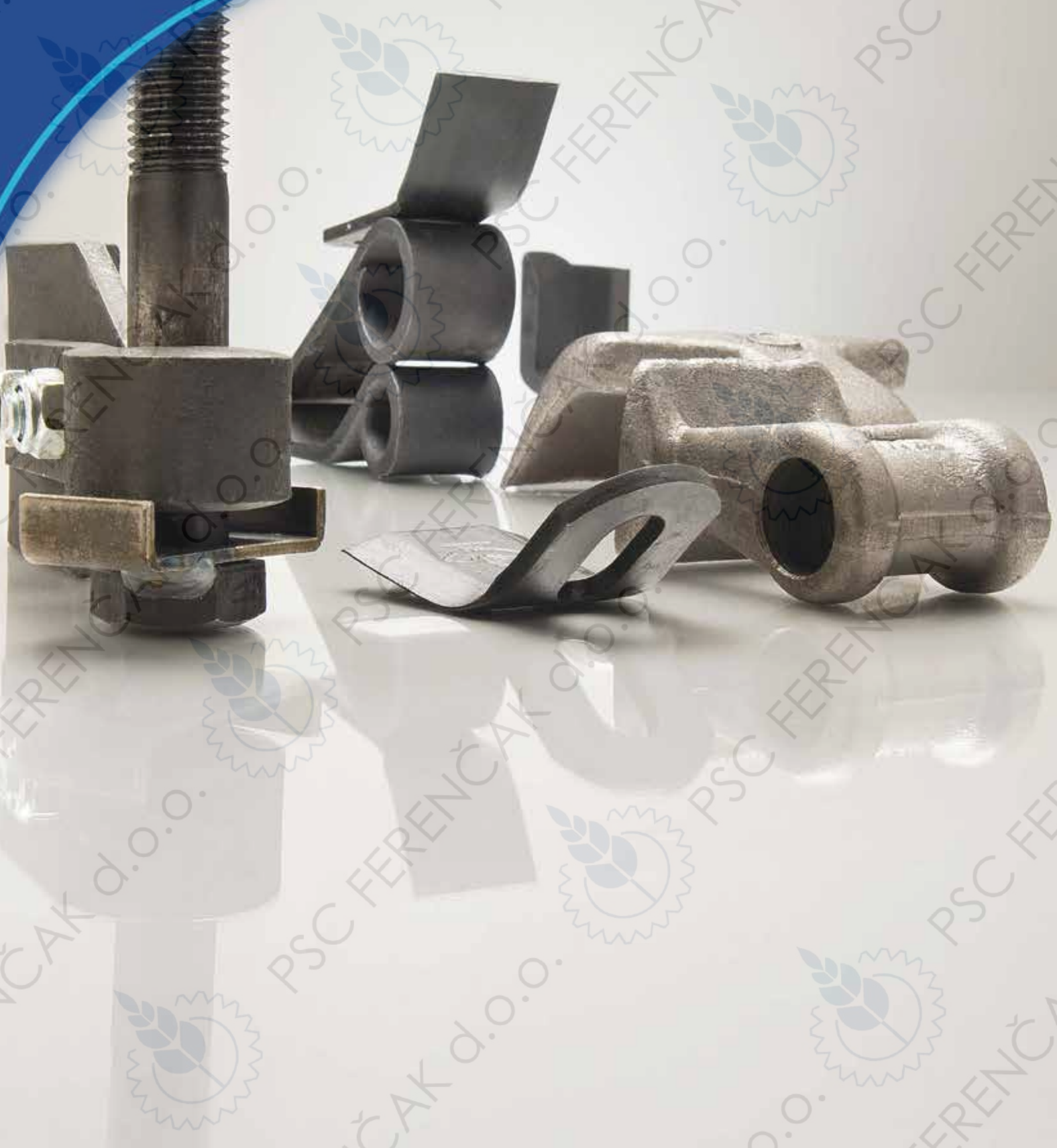

DIJELOVI ZA MALČERE



AGRAM, AGRICOM, AGRIMASTER, AGROMEČ	50
BERRY, BOMFORD, BREVIGLIERI	50
CABE, CALDERONI, CELLI, CLASS, COSMA, DRAGONE	50
FALC, FALCONERO, FENDT, FERRY, FORIGO-ROTERTALIA	50-51
HERDER, HMF, HOWARD, HUMUS, HYMACH, IRUS	51
KIRCNER, KUHN, KVERNELAND	51
MALETTI, MASEGIO, MC CONNEL, M.E.A.A.T., MÖRBA, MÖRTL, MURATORI, MÜTHING	51
MOBILI, OEHLER, OMARV, ORSI	51
PALLADINO, PEGORARO, PERFECT, PERUGINI, PERUZZO, PROCOMAS	51
QUIVOGNE	51
RINIERI, ROTOLAND	51
SAUERBURGER, SCHAUER, SEKO, SEPPI, SIEMA, S.M.A., SOVEMA	51
TAARUP, TERRAL, TERANOVA	51
VIGOLO, VOGEL & NOOT, VOTEX	52
WILLIBALD	52
ZANON, ZAPPATOR	52
NOSAČ NOŽA ZA MALČERE	52
ČEKIČI ZA MALČERE	52-54
Uputa za narudžbu	55



NOŽEVI ZA MALČERE A-C

A-C**ŠIFRA****NAZIV**

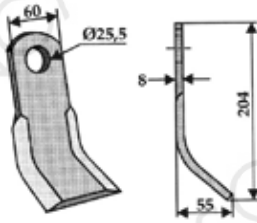
197454 Y Nož malčera
60/55/204
Agricom
odgovara za
modele:
KIRCHNER,
PROCOMAS,
SEKO, SICMA,
OVEMA, VIGOLO,
VOGEL & NOOT



199055 Y Nož malčera
113/52/40/8
Agrimaster

odgovara za
modele:
AGROMEC, FORI-
GO-ROTOITALIA,
MURATORI, ORSI

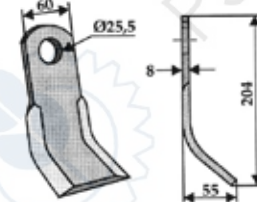

200689 Y Nož malčera
150/60/10
Agrimaster

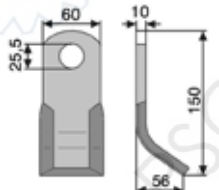

200489 Y Nož malčera
80/35/5
Agrim

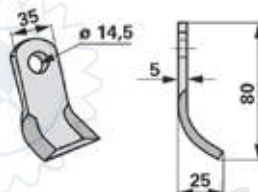

198493 Y Nož malčera
Berry

odgovara za
modele:
BOMFORD,
FERRI,
Mc CONNEL,
S.M.A.

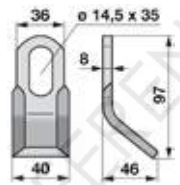

197983 Y Nož malčera
Breviglieri

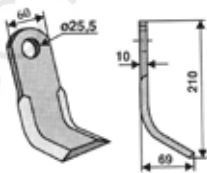

198027 Y Nož malčera
Breviglieri,
Mörtl
odgovara za
modele:
DRAGONE, FALC,
FEHRENBACH,
KUHN, KVERNE-
LAND, MALETTI,
M.E.A.A.T.,
MÖRBA, NOBILI,
OMARV, PALLA-
DINO, PERUGINI,
QUIVOGNE,
VOGEL&Noot

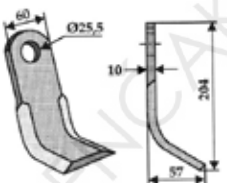

190539 Y Nož malčera
Cabe

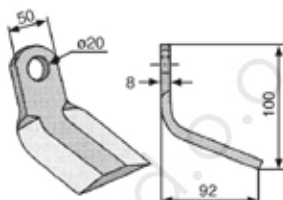

NOŽEVI ZA MALČERE C-F

C-F**ŠIFRA****NAZIV**

199753 Y Nož
malčera
Celli

odgovara
za modele:
AGRICOM,
FALCONERO

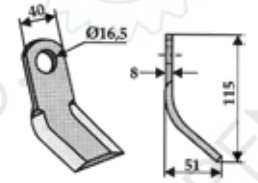

199054 Y Nož
malčera
Cosma
udarni

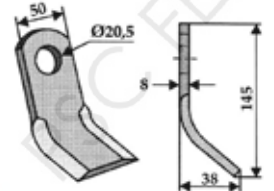

202798 Nož
malčera
ravni D
Epoke

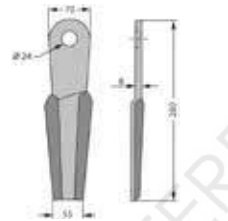

199652 Y Nož
malčera
40/12/35/98
Falc

odgovara
za modele:
GILBERS,
HERDER,
QUIVOGNE,
VOTEX

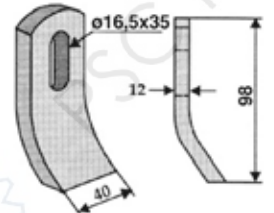

202610 Y Nož
malčera
204/55/60/10
Falc

odgovara za
modele: NOBI-
LI, OMARV

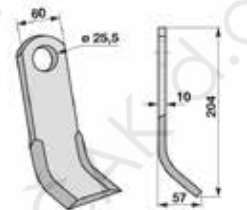

203474 Y Nož
malčera
Ferri

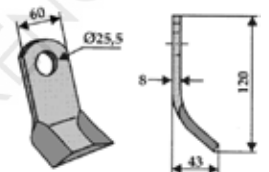

197459 Y Nož
malčera
150/60/8/62
Ferri

odgovara za
modele:
AGRICOM,
FENDT, FERRI,
HOWARD,
PERUGINI,
SCHAUER,
SICMA

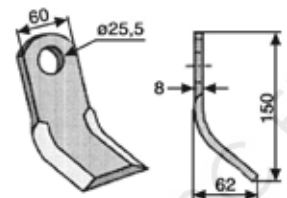

202620 Y Nož
malčera
82/45/40/8
Ferri

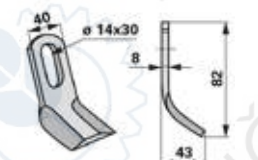



NOŽEVI ZA MALČERE

F-M

ŠIFRA NAZIV

190469 Nož malčera
ravni Ferri

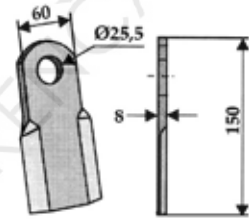

199495 Y Nož malčera
245/70/60/8
Ferri, Claas,
V&N

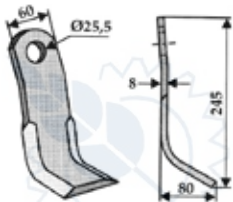

200567 Y Nož malčera
105/40/38
HMF

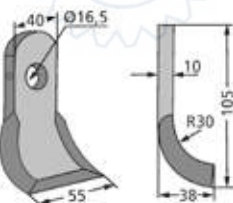

199653 Y Nož malčera 300822
145/50/8
Humus

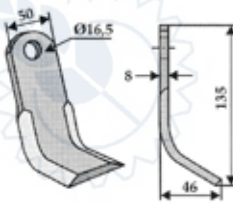

199656 Y Nož malčera
Kuhn

odgovara
za modele:
KVERNELAND,
MALETTI,
NOBILI

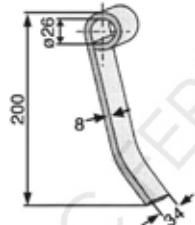

203433 Y Nož malčera
130/40/42
Kuhn

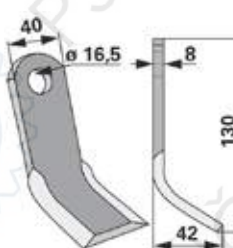

197724 Y Nož malčera
Maschio

odgovara za-
model:
TERANOVA

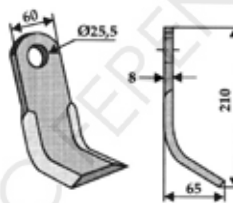

203603 Y Nož malčera
130/45/59 /8
Maschio

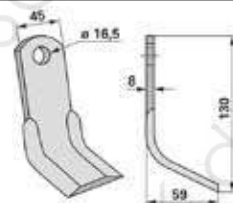

NOŽEVI ZA MALČERE

M-T

ŠIFRA NAZIV

202611 Y Nož malčera
150/55/60/10
Maschio

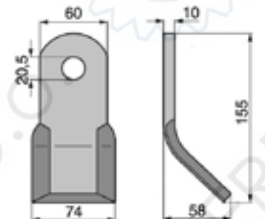

197903 Y Nož malčera
Nobili

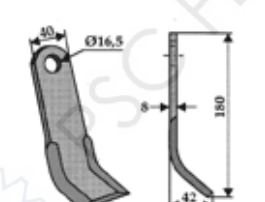

199257 Y Nož malčera
Palladino

odgovara za
model: IRUS

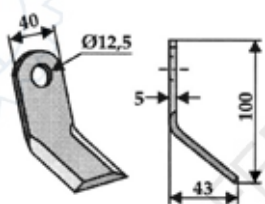

198335 Nož malčera
Perfect

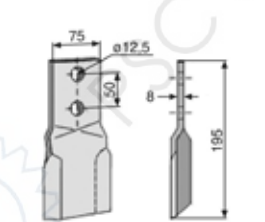

202612 Y Nož malčera
210/65/60/8
Peruzzo

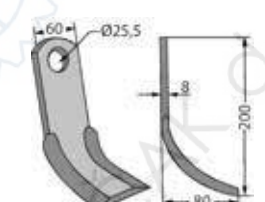

196682 Y Nož malčera
Taarup

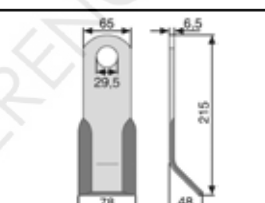

193380 Y Nož malčera
Taarup

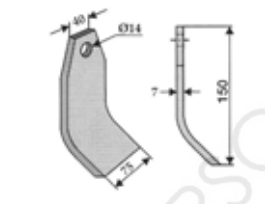

199365 Y Nož malčera
215/65/46/29/7
Taarup

odgovara za
model: AGRAM

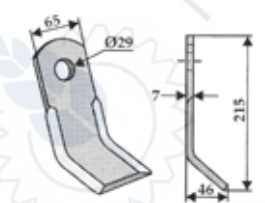

4



NOŽEVI ZA MALČERE V-...

V-...**ŠIFRA NAZIV**

203519 Y Nož malčera
200/60/80/8
V&N

odgovara za
model:
VIGOLO

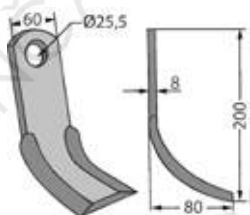

202538 Y Nož malčera
120/70/60/8
Vigolo

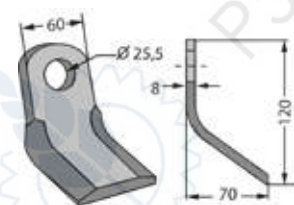

ČEKIČI ZA MALČERE A-B

A-B**ŠIFRA NAZIV**

192308 Čekič
malčera
Agricom

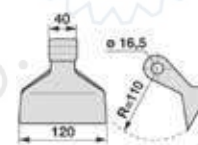

191158 Čekič
malčera
Agrimaster

odgovara
za modele:
HYMACH;
PERUZZO,
PROCOMAS,
SICMA

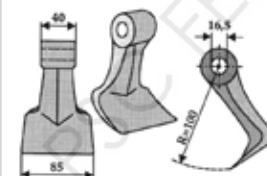

199651 Čekič
malčera
Agrimaster

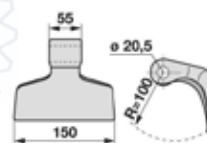

196137 Čekič
malčera
Berti

odgovara za
model: V&N

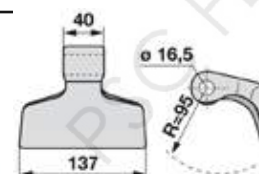

NOSAČ NOŽA ZA MALČERE

ŠIFRA NAZIV

203159 Nosač "U"
za
nož malčera



203149 Nosač "U"
za
nož malčera
zakrivljeni

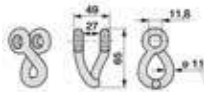

190470 Čekič
malčera
120/40/90
fi 14,5

odgovara za
model: TFZ,
ZANON

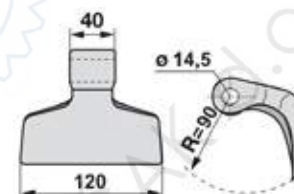

203474 Čekič
malčera
120/40/90
fi 16,5

odgovara
za model:
KVERNELAND,
MALETTI,
MASCHIO,
SICMA

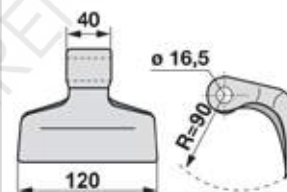

ČAHURA NOŽA MALČERA

ŠIFRA NAZIV

Čahura noža malčera

203172 A=30, l=12,5, L=16 mm

190471 A=20, l=14,5, L=17 mm

203066 A=25, l=16,5, L=21 mm

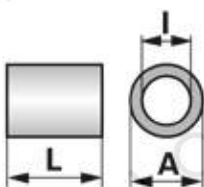

199608 Čekič
malčera
120/40/110
fi 16,5

odgovara za
model:
AGRICOM,
BOMFORD,
Mc. CONNEL,
M.E.A.A., NO-
BILI, OMARV,
PERUGINI,
RINIERI,
ROTLAND,
SEPI, SICMA,
VOGEL&NOOT

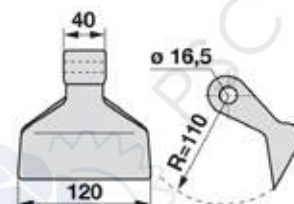



ČEKIČI ZA MALČERE

B-F

ŠIFRA NAZIV

203136 Čekič malčera
190/68/80
fi 16,5

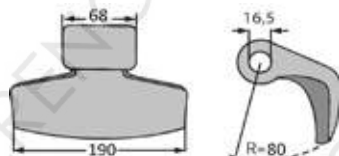

199609 Čekič malčera
120/40/110
fi 18,5
univerzalni

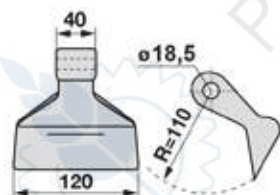

199610 Čekič malčera
150/55/100
fi 20,5

odgovara za
modele:
AGRIMASTER,
AGROME, CAL-
DERONI, FALCO-
NEO, MASCHIO,
MURATORI, CABE,
ORSI, SICMA,
ZANON

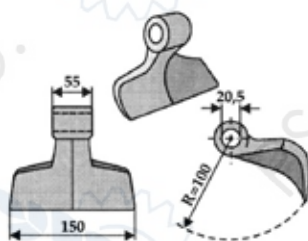

202099 Čekič malčera
130/70/130
fi 20,5

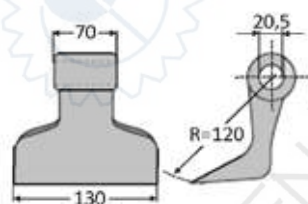

202614 Čekič malčera
200/75/100
fi 20,5

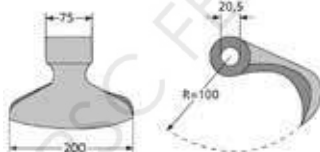

203068 Čekič malčera
50/87/75/26/16
Duecker

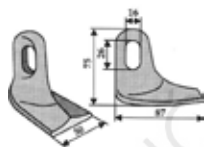

202052 Čekič malčera
90/43/120
fi 16,5
Falc

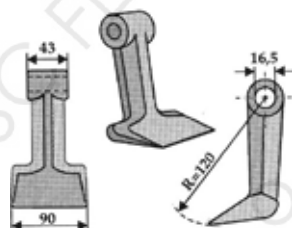

ČEKIČI ZA MALČERE

M-K

ŠIFRA NAZIV

203118 Čekič malčera
80/60/60/70/36
fi 14,2
Ferri

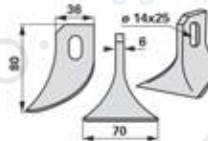

202795 Čekič malčera
180/70/104
fi 16,5
Ferri

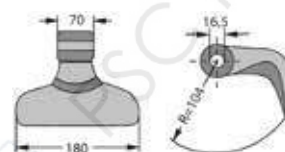

200148 Čekič malčera
16/70/185
HMF

odgovara za model:
ROTORAM

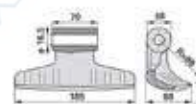

199657 Čekič malčera
HMF

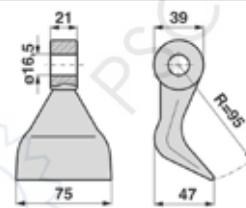

202875 Čekič malčera
170/70/88 fi
16,5
HMF

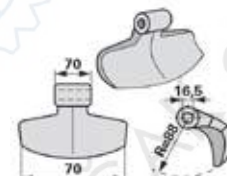

190963 Čekič malčera
137/95/40
fi 16,5
Howard

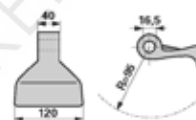

192547 Čekič malčera
150/60/92
fi 20,5
Humus

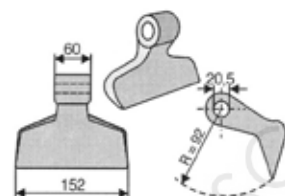

196431 Čekič malčera
155/110/90
fi 20,5
Kuhn

odgovara za
modele:
FEHRENBACH,
KIRCHNER,
NOBILI, WILIBALD

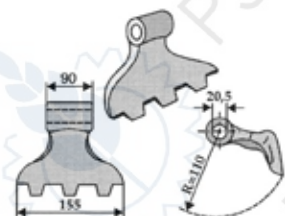

4



ČEKIČI ZA MALČERE K-P

K-P

ŠIFRA NAZIV KAT.BR.

196473 Čekič malčera Kverneland

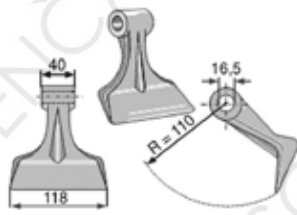

202166 Čekič malčera 155/85/70 fi 16,5 Paladino

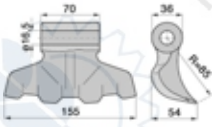

199570 Čekič malčera Perfect

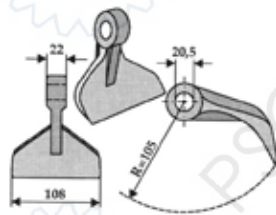

ČEKIČI ZA MALČERE S-V

S-V

ŠIFRA NAZIV KAT.BR.

199494 Čekič malčera Siema

odgovara za modele:
AGRICOM,
AGRITEC,
BERTI,
BREVIGLIERI,
M.E.A.A.T.,
MÜTHING,
OEHLER,
VIGOLO,
VOGEL&NOOT

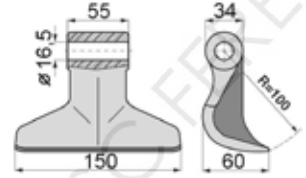

200609 Čekič malčera Vigolo

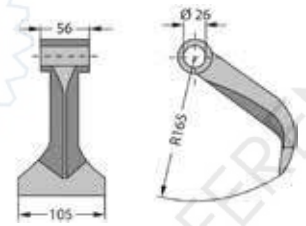

Za narudžbu ili upite o specijaliziranim dijelovima pripremite podatke označene na slikama:



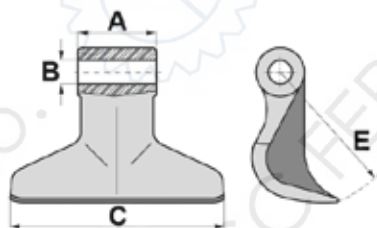

Slika 1

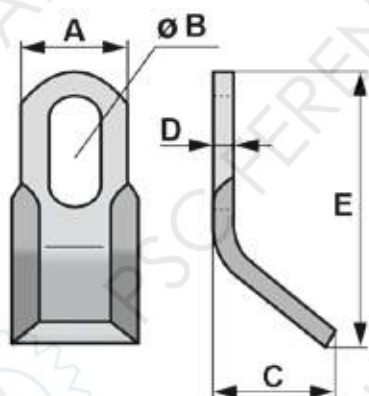

Slika 2

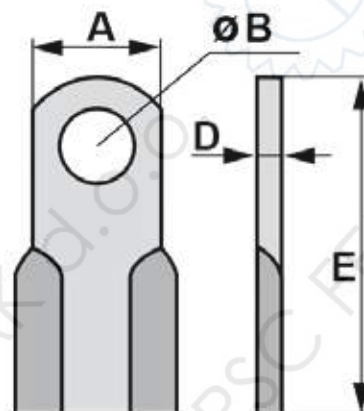

Slika 3

4

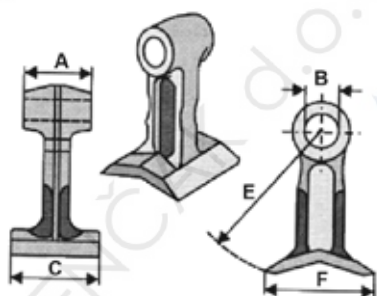

Slika 4

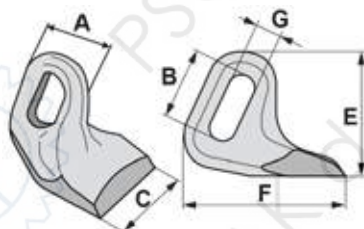

Slika 5

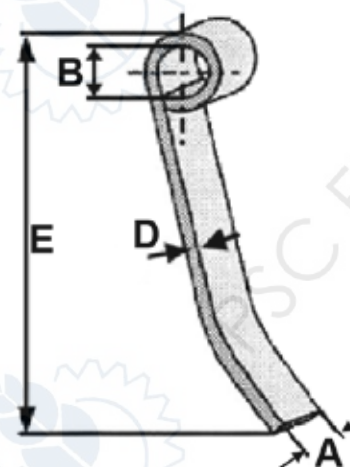

Slika 6

A _____
 B _____
 C _____
 D _____
 E _____
 F _____
 G _____

Proizvođač _____

Tip _____

Količina _____

Slika br. _____

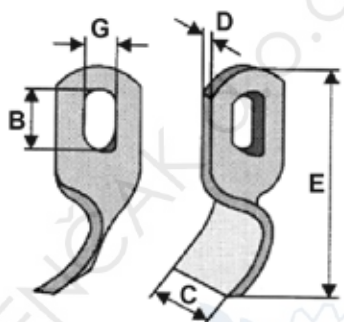

Slika 7

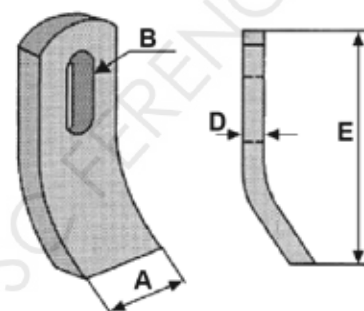

Slika 8

**** Vijke za malčere pronadite na str. 26-28 (Ostali vijci).**



**DIJELOVI ZA GRUBERE,
PODRIVAČE I TANJURAČE**

NOSAČI NOŽA GRUBERA	59
NOŽ GRUBERA DVOSTRANI UNIVERZALNI	59
NOŽ GRUBERA PREDNJI UNIVERZALNI	59
RAONIK GRUBERA	59
MOTIČICA GRUBERA UNIVERZALNA	60
DASKA GRUBERA	61
NOSAČ S NOŽEVIMA GRUBERA	61
KLINOVI DRLJAČA	61
S-OPRUGE SJETVOSPOMAČA	62-63
NOŽEVI "S" PERA	63
MOTIČICE MOTOKULTIVATORA	64
DIJELOVI TANJURAČA	65
DONDI PODRIVAČI I KANALOKOPAČI	66-68



5



- 1 - raonik grubera
- 2 - nosač noža grubera
- 3 - 4 - noževi grubera
- 5 - nož grubera prednji
- 6 - daska grubera prednja



- 1 - nosač noža grubera
- 2 - daska grubera D
- 3 - daska grubera L
- 4 - raonik grubera D
- 5 - raonik grubera L
- 6 - prednji nož grubera
- 7 - nosač raonika i prednjeg noža grubera



NOSAČ NOŽA GRUBERA

ŠIFRA NAZIV KAT.BR.

197197 Nosač noža grubera dvostrani 240203



040485 Nosač noža grubera dvostrani 240204



198460 Nosač noža grubera dvostrani 240220



201002 Nosač noža grubera dvostrani 10751



203416 Nosač noža grubera dvostrani 240201

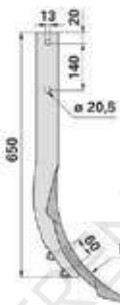

NOŽEVI GRUBERA DVOSTRANI

ŠIFRA KAT.BR.

198344 CV007005

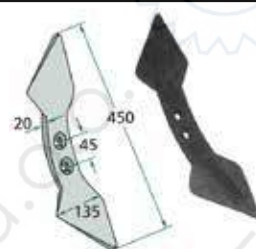

192018 CV008001

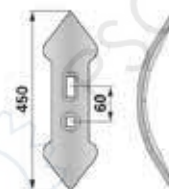

199611 10186



198436 232421

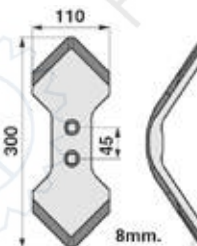

NOŽ GRUBERA PREDNJI

ŠIFRA KAT.BR.

198471 8711215

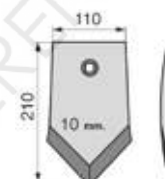

192019 3374388

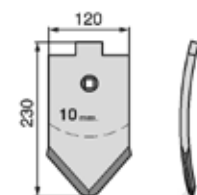

198461 240521

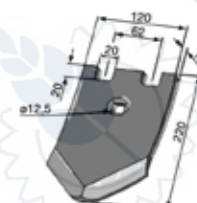



RAONIK GRUBERA

ŠIFRA	NAZIV	KAT.BR.
200535	Raonik grubera Pöttinger D	939502201
200536	Raonik grubera Pöttinger L	939502211
198032	Raonik grubera Rau D / L	240030

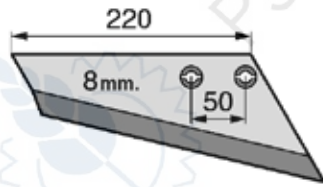
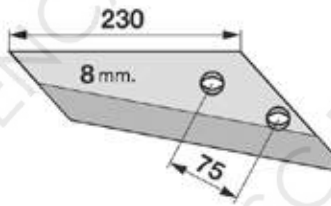

202856	Raonik grubera Rabe D	634250010
202857	Raonik grubera Rabe L	63425009

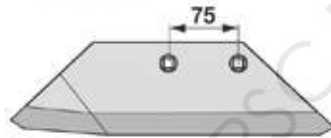

198343	Raonik grubera D	CV004508
198342	Raonik grubera L	CV004509

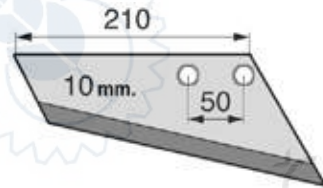

200527	Raonik grubera Frost D	51542
200528	Raonik grubera Frost L	51543

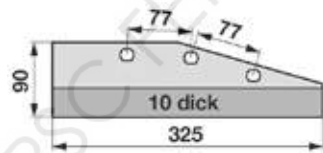

198348	Raonik grubera Lemken D	3374416
198349	Raonik grubera Lemken L	3374417

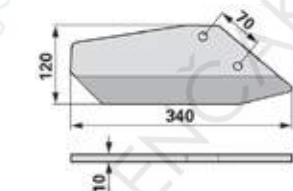

198345	Raonik grubera Regent D	87112141
198346	Raonik grubera Regent L	87112142

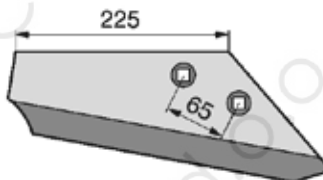

RAONIK GRUBERA

ŠIFRA	NAZIV	KAT.BR.
191963	Raonik grubera Lemken zakrivljeni D	3374418
191964	Raonik grubera Lemken zakrivljeni L	3374419



MOTIČICA GRUBERA

ŠIFRA	KAT.BR.
198326	240190

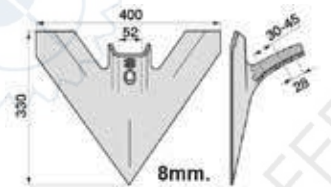

197266	240541
--------	--------

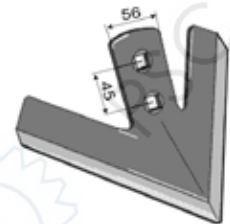

191372	191372
--------	--------

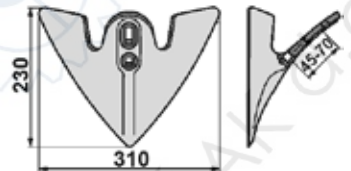

MOTIČICA GRUBERA

ŠIFRA	NAZIV	KAT.BR.
193844	Nosač noža grubera	240148

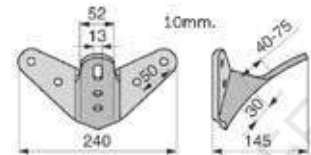

200531	Nosač noža grubera Lemken	4679105
--------	---------------------------	---------

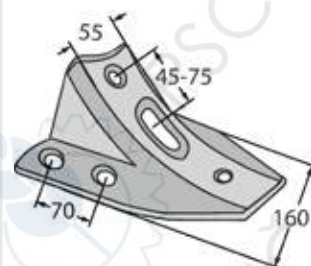



DASKA GRUBERA

ŠIFRA NAZIV KAT.BR.

200532 Daska noža grubera Lemken - gornja 3374395



200533 Daska grubera Lemken D 3374398

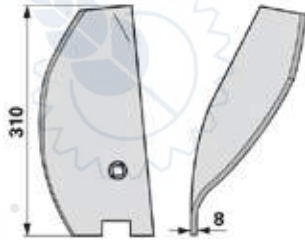

203534 Daska grubera Lemken L 3374399



NOSAČ S NOŽEVIMA GRUBERA

ŠIFRA NAZIV KAT.BR.

202105 Nosač s noževima za gruber 370 mm, KPL CV004600

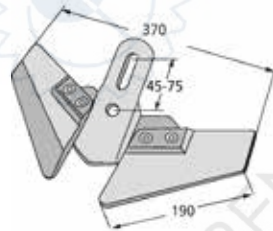

202106 Nosač s noževima za gruber 450 mm, KPL CV00460A

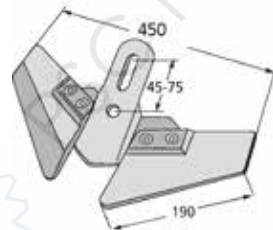

NOSAČ S NOŽEVIMA GRUBERA

ŠIFRA NAZIV KAT.BR.

193892 Nosač podrivača Pergoraro 100 mm 240728

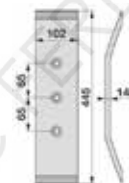

193893 Nosač podrivača Pergoraro 70 mm 240729

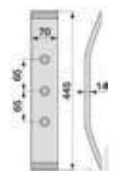

KLINOVI DRLJAČA

ŠIFRA NAZIV

198553 Klin drljače ravni 16x190xM12



201212 Klin drljače ravni 22x240xM20



199166 Klin teške brane 30x200xM24



191050 Klin drljače povinuti 20x220



191051 Klin pačja noga

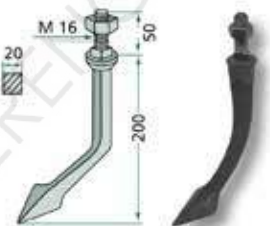



PERA SJETVOSPREMAČA

ŠIFRA	NAZIV	
202657	"S" pero zakrivljeno unazad 25x8x375	
201141	"S" pero malo ravno 32x10x290	
202656	"S" pero bez nožića 27x10x370	
202703	"S" pero Lemken 27x10x270	
197658	"S" pero 32x12x590	
040504	"S" pero 32x12x600	
194074	"S" pero 25x8x345	

PERA SJETVOSPREMAČA

ŠIFRA	NAZIV	
196521	"S" pero 25x8x380	
100559	"S" pero veliko s nožićem 32x10x550	
202658	"S" pro veliko 32x10x550	
192910	"S" pro s nožićem Rau 32x10x550	
192920	"S" pero zakrivljeno Rau 32x10	
192911	"S" pero ravno s nožićem-manje 32x10 40x5x135	
192912	"S" pero ravno s nožićem-veliko 32x12 40x5x195	

5



PERA SJETVOSPREMAČA

ŠIFRA NAZIV

192921 "S" pero ravno
s nožićem
32x10



NOŽEVI "S" PERA

ŠIFRA NAZIV

192919 Nožić "S"
pera ravni
40x195

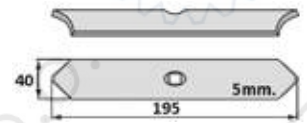

195795 Nožić "S"
pera 40x5
zakrivljen

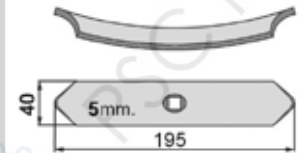

202624 Nožić "S"
pera 40x6
zakrivljen

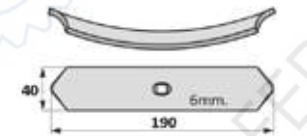

192913 Nožić "S"
pera Rau
konveksni

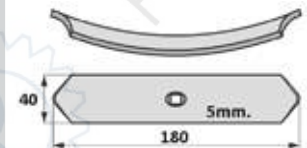

192914 Nožić "S"
pera ravni
35x135

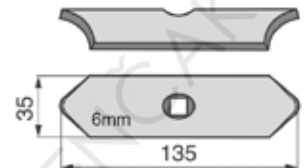

DRŽAČ PERA SJETVOSPREMAČA

ŠIFRA NAZIV

190855 Držač "S" pera
50x12

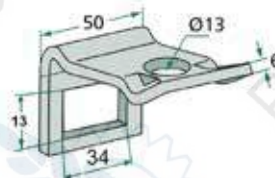

199492 Držač "S" pera
32x10
dupli



199811 Držač "S" pera
40x10
manji



NOŽEVI "S" PERA

ŠIFRA NAZIV

190799 Nož "S" pera
Bellota

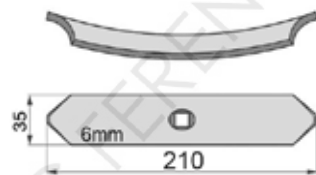

200222 Nož "S" pera

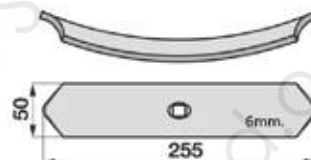

DODACI ZA PERA

191386 Pojačanje
"S" pera
32x10

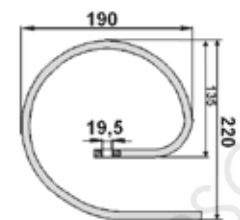

190798 Vijak nožića
"S" pera
M10

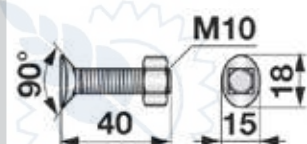

5



MOTIČICE KULTIVATORA

ŠIFRA NAZIV

199239 Motičica 135 mm

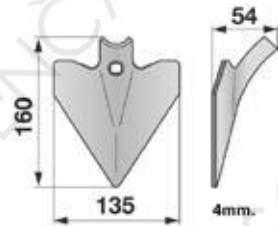

200223 Motičica 105x4

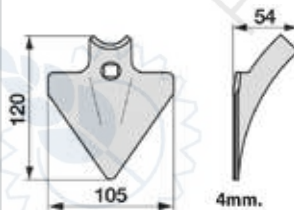

191382 Motičica "lastin rep" D

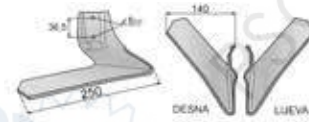

191383 Motičica "lastin rep" L

192917 Motičica 175x4

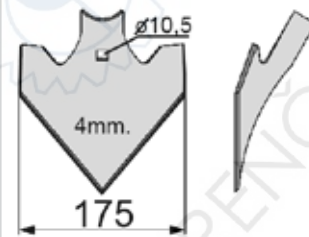

192112 Motičica 150x4 Rau

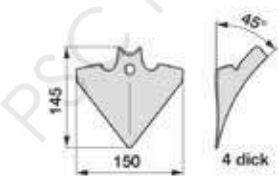

192155 Motičica 160x10 Rau

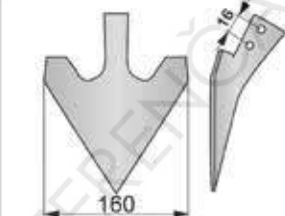

195921 Motičica "pačja noga" OLT

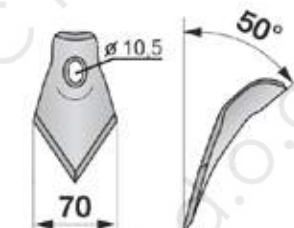

192918 Motičica "pačja noga"

DIJELOVI TANJURAČA

nazubljeni diskovi

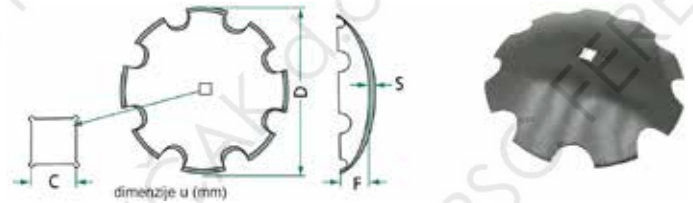

ŠIFRA	D (mm)	C (mm)	S (mm)
10150	460	25	3,5
100152	460	30	6,5
100149	510	30	5
100170	560	30	5
191808	560	35	6
192643	560	40,5	5
192336	610	32,5	6
191807	610	41,5	6
100248	660	40	8

glatki diskovi

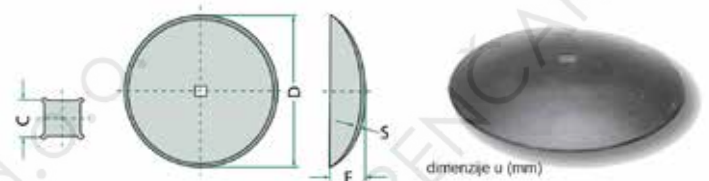

ŠIFRA	D (mm)	C (mm)	S (mm)
100558	460	25	3,5
100151	460	30	3,5
100153	510	30	5
100169	560	30	5
192642	560	40,5	5
191806	610	41,5	6
190258	660	40	8



DIJELOVI TANJURAČA

osovina tanjurača



ŠIFRA	DEBLJINA	OPIS
192648	30x30	TANJURAČA 20 DISKA OLT
192607	25x25	TANJURAČA 20 DISKA OLT
190214	25x25	TANJURAČA 24 DISKA OLT
192649	30x30	TANJURAČA 24 DISKA OLT
190213	25x25	TANJURAČA 28 DISKA OLT
100302	30x30	TANJURAČA 28 DISKA OLT
196984	40x40	L=2600mm

OSTALI DIJELOVI TANJURAČA

ŠIFRA NAZIV

190579 Kućište ležaja tanjurače OLT



194767 Kućište ležaja tanjurače RAU



198956 Ležaj tanjurače D=25

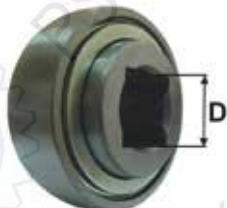

198964 Ležaj tanjurače D=30



100415 Odstojnik diska A=25 OLT



202209 Odstojnik diska A= 30 OLT



100413 Odstojnik ležaja A= 25 OLT

100207 Odstojnik ležaja A=30 OLT

DIJELOVI TANJURAČA

ŠIFRA NAZIV

198626 Potiskivač diska A=25 OLT



198627 Potiskivač diska A=30 OLT

100403 Prirubnica diska A=25 OLT

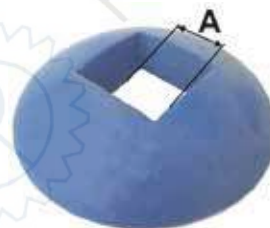

192774 Prirubnica diska A=30 OLT

100212 Matica osovine tanjurače M25

196463 Matica osovine tanjurače M30



100400 Podloška matice M25
192347 Podloška matice M30



100402 Strugač tanjurače OLT limeni D

100401 Strugač tanjurače OLT limeni L



197432 Strugač tanjurače OLT D

197431 Strugač tanjurače OLT L



193239 Nosač drvenog ležaja tanjurače leskovačke A=25



192851 Nosač drvenog ležaja tanjurače leskovačke



5



DIJELOVI TANJURAČA

ŠIFRA	NAZIV
199654	Ležaj tanjurača s gumenom brtvom 511UC
100514	Ležaj drveni za tanjurače leskovačke



LEŽAJ TANJURAČA



ŠIFRA	NAZIV	D (mm)
199125	Ležaj tanjurače s metalnim kućištem ST491	30,5
200162	Ležaj tanjurače s metalnim kućištem ST740	36
200161	Ležaj tanjurače s metalnim kućištem ST740	55









Informacije i narudžbe za sve artikle možete dobiti u našim poslovnicama ili na WEB stranici

www.psc-ferencak.hr

Križevci	Koprivnica	Osijek	Bjelovar	Virovitica
Nikole Tesle 12	Čarda 6	Livana, Omladinska 128	Gudovečka cesta 25	Poduzetnička zona II/12
48 260 Križevci	48 000 Koprivnica	31 000 Osijek	43 000 Bjelovar	33 000 Virovitica
tel.: 048 681 902	tel.: 048 647 902	tel.: 031 211 902	tel.: 043 235 902	tel.: 033 728 902
fax.: 048 682 903	fax.: 048 647 902	fax.: 031 211 902	fax.: 043 235 902	fax.: 033 728 902
web: www.psc-ferencak.hr		e-mail: info@psc-ferencak.hr		



DONDI PODRIVAČI I KANALOKOPAČI

ŠIFRA	NAZIV	KAT.BR.	ŠIFRA	NAZIV	KAT.BR.
191609	Nož rezni DONDI S45A	607003	191610	Zupčanik Z10 DMR 45-55	604017
			190976	Zupčanik Z12 DMR 25-25	604015
191608	Nož rezni DONDI S45B	232403	190971	Zupčanik Z16 DMR 25-35	604001
			191607	Zupčanik Z23 DMR 45-55	604018
196468	Nož DONDI 60x10	607044	190972	Zupčanik Z23 DMR25	604016
			193082	Zupčanik Z23	604002
196469	Nož DONDI 70x12	607040	191606	Osovina DMR 25-35	604063
					
193083	Nož kanalokopača DONDI DXDG	627001			
					
193084	Nož kanalokopača DONDI SXDG	627002			
					

5

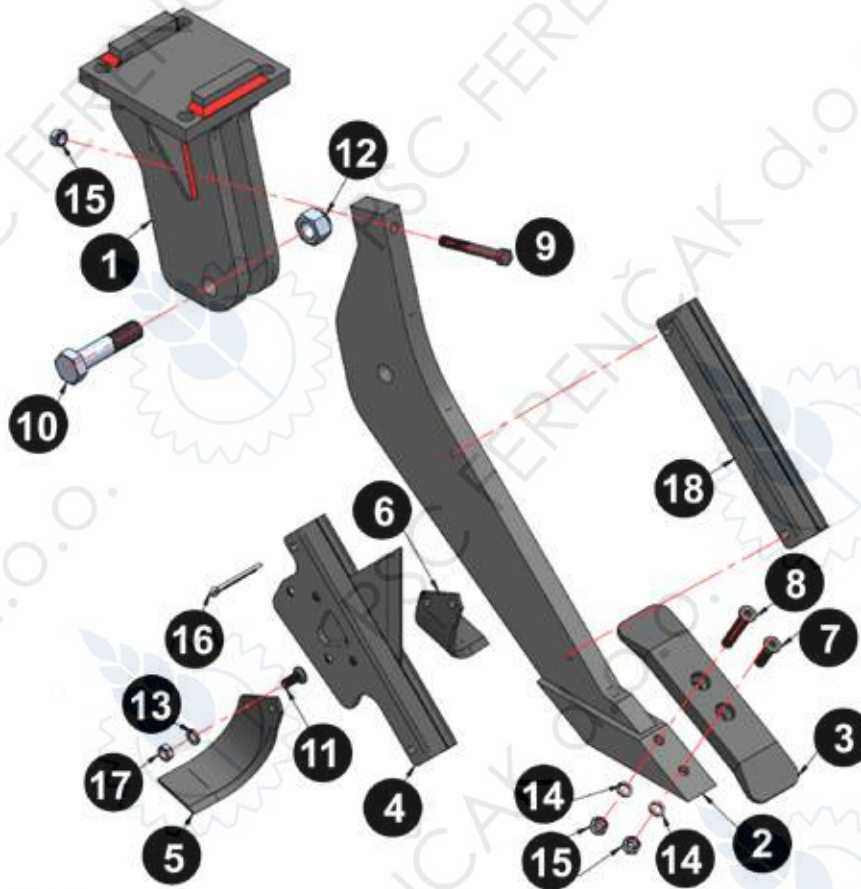

**DONDI PODRIVAČI****5**

ŠIFRA	POZICIJA	KATALOŠKI BROJ	NAZIV	KOLIČINA
199584	1	294295	Nosač tijela podrivača	11
199585	2	294285	Tijelo podrivača	11
197931	3	140028	Nož podrivača dvostrani	11
199586	4	294291	Nosač motičica	11
197932	5	140030	Motičica zakrivljena desna	11
197933	6	140031	Motičica zakrivljena lijeva	11
197934	7	522185	Vijak noža	11
197935	8	522189	Vijak noža	11
199380	9	520104	Vijak noža	11
-	10	520222	Vijak nosača	11
197936	11	522171	Vijak motičice	44
-	12	524136	Matica	11
197937	13	523006	Podloška	44
197938	14	523007	Podloška	22
197939	15	524025	Matica	33
-	16	525068	Rascjepka	22
190892	17	524024	Matica	44
-	18	294290	Zaštita nosača	11



Prostor za bilješke



PSC ferencak









**DIJELOVI ZA SIJAČICE****CIJEVI TELESKOPA****72****GUME TELESKOPA****73****OSTALI DIJELOVI ZA SIJAČICE****74-75****DIJELOVI SIJAČICE GASPARDO****75****DIJELOVI SIJAČICE OLT****76-79**

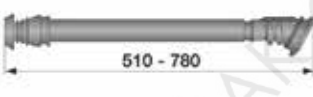
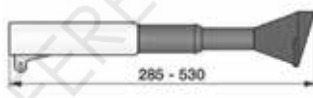

DIJELOVI ZA SIJAČICE

CIJEVI TELESKOPA

ŠIFRA	NAZIV	KAT.BR.	ŠIFRA	NAZIV	KAT.BR.
199538	Cijev teleskopa Amazone 4 dijela	317035	199806	Cijev teleskopa Isaria 195-535	318360
			202064	Cijev teleskopa Isaria 180-525	318361
201996	Cijev teleskopa Amazone D7	3182500			
			203561	Cijev teleskopa Kuhn duža	N03322A0
192460	Cijev teleskopa Amazone KPL	317028			
			203772	Cijev teleskopa Lemken-Hassia	5818604
199549	Cijev teleskopa Amazone L=730	317036			
			203874	Cijev teleskopa Lemken-Hassia duža	5818601
199548	Cijev teleskopa Amazone L=670	317037			
			200830	Cijev teleskopa Reform L=170	318382
199539	Cijev teleskopa Amazone L=760	317039			
			202156	Cijev teleskopa Reform L=205	318390
200873	Cijev teleskopa Fiona	318511			
					
200948	Cijev teleskopa Gaspardo duža	07002742			
					
200949	Cijev teleskopa Gaspardo kraća	07002741			
					



6



DIJELOVI ZA SIJAČICE

GUME TELESKOPA

ŠIFRA	NAZIV	KAT.BR.	
202689	Guma teleskopa Amazone	951955	
199533	Guma teleskopa Amazone donja	317026	
203696	Guma teleskopa Amazone donja	3333200	
202012	Guma teleskopa Amazone gornja kosa	3188500	
202011	Guma teleskopa Amazone gornja ovalna	3181500	
201997	Guma teleskopa Amazone gornja ravna	3017300	
202883	Guma teleskopa Gaspardo gornja	19003070	
199543	Guma teleskopa Isaria	318356	
203870	Guma teleskopa Lemken-Hassia donja	4818581	
203872	Guma teleskopa Lemken-Hassia gornja	4818580	
202157	Guma teleskopa Reform	318384	

OSTALI DIJELOVI

ŠIFRA	NAZIV	KAT.BR.	
202015	Izbacivač sjemena Amazone fini dupli red	3648300	
202013	Izbacivač sjemena Amazone D7	3371100	
202016	Izbacivač sjemena Amazone D7, D8	3649300	
199620	Klapna sijačice Amazone	317024	
193129	Priključak Amazone	317023	
193920	Spirala 10 Gama Lucerna	6209165	
193919	Spirala 25 Gama Pšenica	6209164	
193918	Skala sjemena Gama	002129	
193921	Cijev tanja Gama	6211242	







DIJELOVI ZA SIJAČICE

OSTALI DIJELOVI

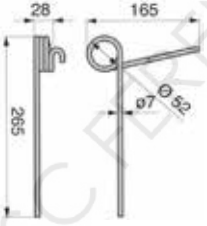
ŠIFRA	NAZIV	KAT.BR.	
195784	Vijak "U" za sekciju Gama	6211242	
199594	Poluga okretišta	6201171	
193924	Zupčanik Z15 Gama	621784	
200878	Obujmica manja Gama	6217246	
200877	Obujmica veća Gama	008435	
196205	Disk s glavčinom Gama KPL	620104	
194920	Glavčina diska Gama	1060393	
197285	Disk ulagača	198112	
190611	Opruga sijačice Amazone prednja	310302	
199554	Opruga sijačice Amazone stražnja	310301	
202666	Opruga sijačice Kuhn-Nodet prednja	FKX0383C	

OSTALI DIJELOVI

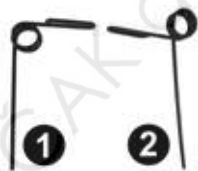
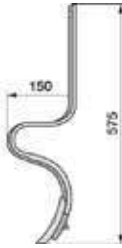
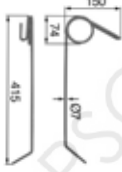
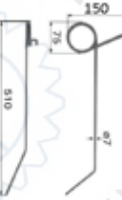
ŠIFRA	NAZIV	KAT.BR.	
202697	Opruga sijačice Kuhn-Nodet stražnja	FKX0385C	
197257	Opruga sijačice Fedher	230813	
197621	Opruga sijačice Hassia, Isaria, Lemken	230830	
198448	Opruga sijačice Hassia, Isaria, Lemken	230870	
203567	Opruga sijačice Panonia D (slika 1)	230870	
203568	Opruga sijačice Panonia L (slika 2)		
203710	Opruga sijačice Amazone	3116000	
202129	Opruga Gaspardo kraća	18903640	
202130	Opruga Gaspardo dulja	18903650	



DIJELOVI ZA SIJAČICE

OSTALI DIJELOVI

ŠIFRA	NAZIV	KAT.BR.
202060	Opruga Hassia prednja	3537047
193938	Opruga Hassia stražnja	3537046

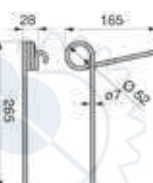
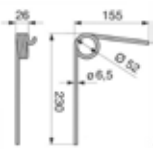

DIJELOVI SIJAČICE GASPARDO

ŠIFRA	NAZIV	KAT.BR.
201278	Ulađač gnojiva Gaspardo	16670600
201359	Nož ulagača Gaspardo	22270397
200244	Ležaj Gaspardo kvadratne osovine	614830390
195218	Štift plastični Gaspardo	66248057



DIJELOVI SIJAČICE GASPARDO

ŠIFRA	NAZIV	KAT.BR.
194466	Pločica sjetvena Gaspardo 26x4,5	22230050
201416	Pločica sjetvena Gaspardo 26x5,5	22230049
202687	Pločica sjetvena repa-sirak Gaspardo 36x2,1	99501603
198884	Prsten klizni Gaspardo ploče	66248068
201413	Zupčanik sijačice Gaspardo	20860126
201414	Zupčanik sijačice Gaspardo Z18	302176
202441 202444 202542	Pušnica Gaspardo	66248051 66349001 66349008



Posjetite nas u našim centrima!

KRIŽEVCI, Nikole Tesle 12
48 260 Križevci
tel.: 048 681 902
fax.: 048 682 903

KOPRIVNICA, Čarda 6
48 000 Koprivnica
tel.: 048 647 902
fax.: 048 647 902

OSIJEK, Livana, Omladinska 128
31 000 Osijek
tel.: 031 211 902
fax.: 031 211 902

BJELOVAR, Gudovečka cesta 25
43 000 Bjelovar
tel.: 043 235 902
fax.: 043 235 902

VIROVITICA, Poduzetnička zona II/12
33 000 Virovitica
tel.: 033 728 902
fax.: 033 728 902



DIJELOVI ZA SIJAČICE

DIJELOVI SIJAČICE OLT

ŠIFRA	NAZIV	KAT.BR.
100404	Poklopac	203255
100406	Dno lonca	
191169	Poklopac dna lonca sjemena	
100417	Skala MSK ST	0902235
100446	Izbacivač gnojiva 244/A	0902244
190977	Ležaj kotača SKPT-92	
191952	Ležaj 1304-83 OLT	9498990



DIJELOVI SIJAČICE OLT

ŠIFRA	NAZIV	KAT.BR.
194143	Skala MSK D / L	6002291
198766	Regulator umjetnog gnojiva PSK D	6002050003
197014	Regulator umjetnog gnojiva PSK L	6002050004
191955	Izbacivač metalni	9324267
100197	Opruga blokade PSK	6406514
195981	Opruga pogona kotača PSK	64061151
197731	Opruga zagrtča PSK	6406441
192872	Opruga napinjača lanca	1304200
196511	Kućište KPT OLT Skidač+ izbacivač ORIGINAL	
100132	Kućište KPT OLT Skidač+ izbacivač ZAMJENSKI	



6



DIJELOVI ZA SIJAČICE

DIJELOVI SIJAČICE OLT

ŠIFRA	NAZIV	KAT.BR.	
100068	Izbacivač OLT ORIGINAL		
190712	Skidač zrna OLT ORIGINAL		
196510	Opruga za izbacivač OLT ORIGINAL		
100163	Skidač + izbacivač KPT ZAMJENSKI		
100405	Plast lonca		
100409	Poklopac lonca		
190240	Zupčanik Z10 MSK za sjeme	9499229	
100028	Zupčanik Z11		
190202	Zupčanik Z19	9499423	
100398	Zupčanik Z40	9499067	
191953	Lonac metalni MSK	0405159	
191954	Poklopac lonca MSK	0405167	

DIJELOVI SIJAČICE OLT

ŠIFRA	NAZIV	KAT.BR.	
100407	Ležaj osovine gnojiva MSK		
100408	Ležaj osovine sjemena MSK		
193448	Puškica napinjača lanca	1304204	
191103	Ploča sjetvena 22 x 4,5 PSK	9674403	
100194	Ploča sjetvena 22 x 5,5 PSK	640614S	
190882	Prsten klizni PSK		
190196	Zupčanik PSK Z15 PVC		
100203	Zupčanik PSK Z24 PVC		
190241	Zupčanik PSK Z12	6406546	
191109	Stožek PSK		
190939	Ležaj čahura 16x20x32 PSK	6406271	



DIJELOVI ZA SIJAČICE

DIJELOVI SIJAČICE OLT

ŠIFRA	NAZIV	KAT.BR.	
192051 192052	Puškica	6406452/A 6406452/B	
100411	Sinter čahura 16x20x16 PSK	6406532	
191975	Sinter čahura 20x24x16 PSK	6406592	
100211	Čahura 32x40x20x48 PSK	6406157	
191073	Čahura PSK	6406603	
191081	Čahura 16x20x16x24 PSK	6406533	
100196	Štift plastični		
190946	Čep plastični PSK	6406645	
190205	Ulagač univerzalni PSK	6406-10/A	
193449	Nož ulagača univerzalni	6406-323/A	

DIJELOVI SIJAČICE OLT

ŠIFRA	NAZIV	KAT.BR.	
195202	Ulagač gnojiva PSK	65290601	
191948	Kutija limena	9684700	
196421	Naljepnica razmaka sjetve PSK	6406557	
200203	Naljepnica skale dubine PSK	6406430	
196528	Osovinica	6406269	
196803	Ležajna čahura	6406284	
197709	Ležajna čahura četvrtaste osovine	651486	
194024	Lančanic gnojivo kvadrat PSK	651900	
198989	Lančanic gnojivo PSK	651901	

6



DIJELOVI ZA SIJAČICE

DIJELOVI SIJAČICE OLT

ŠIFRA NAZIV KAT.BR.

197708 Podloška brtve PSK 6406550



191071 Osigurač PSK 6406445



Lance za sijačice potražite u poglavlju br. 17 (Lanci).
Lanci se prodaju po dužnom metru.

DIJELOVI SIJAČICE OLT

SJETVENE PLOČE



6

ŠIFRA	OZNAKA	BR. RUPA	MODEL
202474	Ploča sjetvena 8 MSK	8	OLT
203950	Ploča sjetvena 8 MSK	8	OLT zamjenska
100062	Ploča sjetvena 9 MSK	9	OLT
100061	Ploča sjetvena 9 MSK	9	OLT zamjenska
196531	Ploča sjetvena 10 MSK	10	OLT
203947	Ploča sjetvena 10 MSK	10	OLT zamjenska
100064	Ploča sjetvena 11 MSK	11	OLT
203948	Ploča sjetvena 11 MSK	11	OLT zamjenska
100065	Ploča sjetvena 12 MSK	12	OLT
203949	Ploča sjetvena 12 MSK	12	OLT zamjenska
202475	Ploča sjetvena 13 MSK	13	OLT
203951	Ploča sjetvena 13 MSK	13	OLT zamjenska



Prostor za bilješke



**DIJELOVI ZA CISTERNE****VAKUUM PUMPE I DIJELOVI ZA
VAKUUM PUMPE****82-87****USISNA CRIJEVA I PRIBOR****87-89****ZASUNI I RAZNI DIJELOVI****89-91****TALIJANSKI SISTEM BRZOG
KOPČANJA****93-95****PERROT SISTEM BRZOG
KOPČANJA****96****BAUER SISTEM BRZOG KOPČANJA****97****VATROGASNI PRIKLJUČCI (STORZ)****98****7**

**VAKUUM PUMPE****VAKUUM PUMPA DKP (CREINA)**

ŠIFRA	MODEL	PRIKLJUČAK mm	KAPACITET l/min	MAX. TLAK bar	MAX. VAKUUM bar	POTREBNA SNAGA kW
030003	DKP-3	44	2280	1,5	0,95	8,5
190383	DKP-4	44	3300	1,5	0,95	11

VAKUUM PUMPA MEC

ŠIFRA	MODEL	PRIKLJUČAK mm	KAPACITET l/min	MAX. TLAK bar	MAX. VAKUUM bar	POTREBNA SNAGA kW
199755	MEC 2000	60	2750	1,5	0,8	8,5
196541	MEC 3000	60	3600	1,5	0,8	11
197028	MEC 4000	60	4350	1,5	0,8	14
196681	MEC 5000	60	6150	1,5	0,8	17,5
199754	MEC 6500	60	7000	1,5	0,8	18,5
197122	MEC 8000	80	8100	1,5	0,8	24
203807	MEC 13500	100	13845	2,5	-	-

MAZIVO VAKUUM PUMPE

ŠIFRA	NAZIV	KAT.BR.	ŠIFRA	NAZIV	KAT.BR.
-------	-------	---------	-------	-------	---------

197470 Ulje za vakuum
pumpu 5 L



194105 Crijevo kapaljke
ulja





DIJELOVI VAKUUM PUMPE DKP (CREINA)

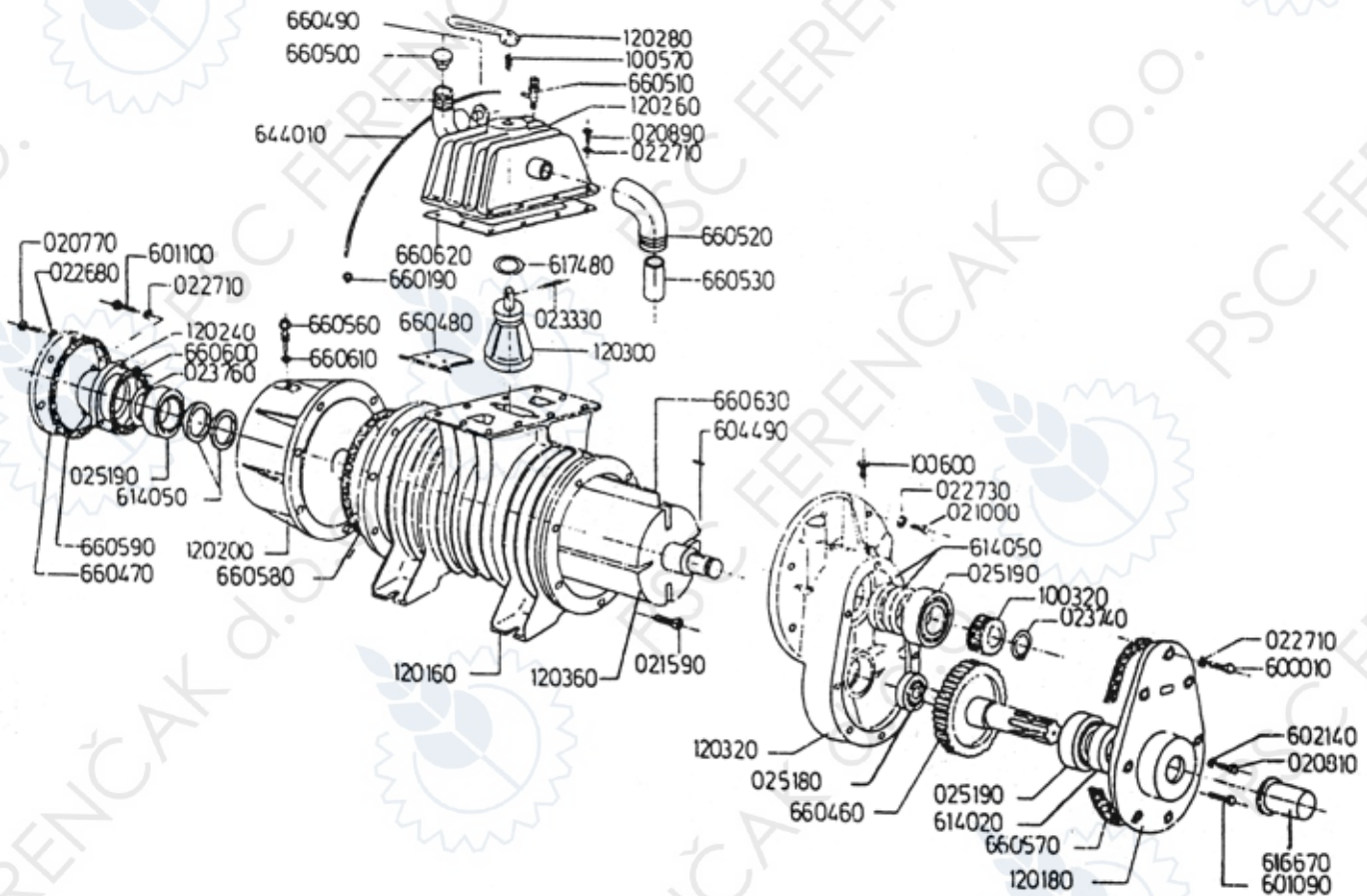

7

Rb.	ŠIFRA	POZICIJA NA SKICI	NAZIV	OPIS
1	190533	120300	BAT PUMPE	DKP-3, DKP-4
2	194106	120280	RUČICA BATA PUMPE	DKP-3, DKP-4
3	030021	660630	LAMELA	DKP-3
4	030024	660540	LAMELA	DKP-4
5	192539	-	LAMELA	DKP-8
6	194457	-	UVODNIK CRIJEVA ULJA	DKP-3, DKP-4
7	030027	660560	MJERAČ ULJA	DKP-3, DKP-4
8	198927	025180	LEŽAJ	DKP-3, DKP-4
9	190784	025190	LEŽAJ	DKP-3, DKP-4
10	199269	614050	SEMERING	DKP-3, DKP-4 (4kom)
11	202093	C660580	SET BRTVI	DKP-3, DKP-4
12	194105	644010	CRIJEVO ULJA	DKP-3, DKP-4
13	030028	660510	KAPALJKA ULJA	DKP-3, DKP-4
14	199785	C162840	DISTANCA ZUPČANIKA	DKP-3, DKP-4
15	193883	-	KUČIŠTE PUMPE	DKP-4
16	202094	C120320	KUČIŠTE ROTORA PUMPE	DKP-4
17	192695	-	OSOVINA SA ZUPČANIKOM	DKP-8
18	192696	-	ZUPČANIK	DKP-8
19	030049	-	ZUČANIK VELIKI	DKP-3, DKP-4



DIJELOVI VAKUUM PUMPE MEC 2000 - 4000 / M

7

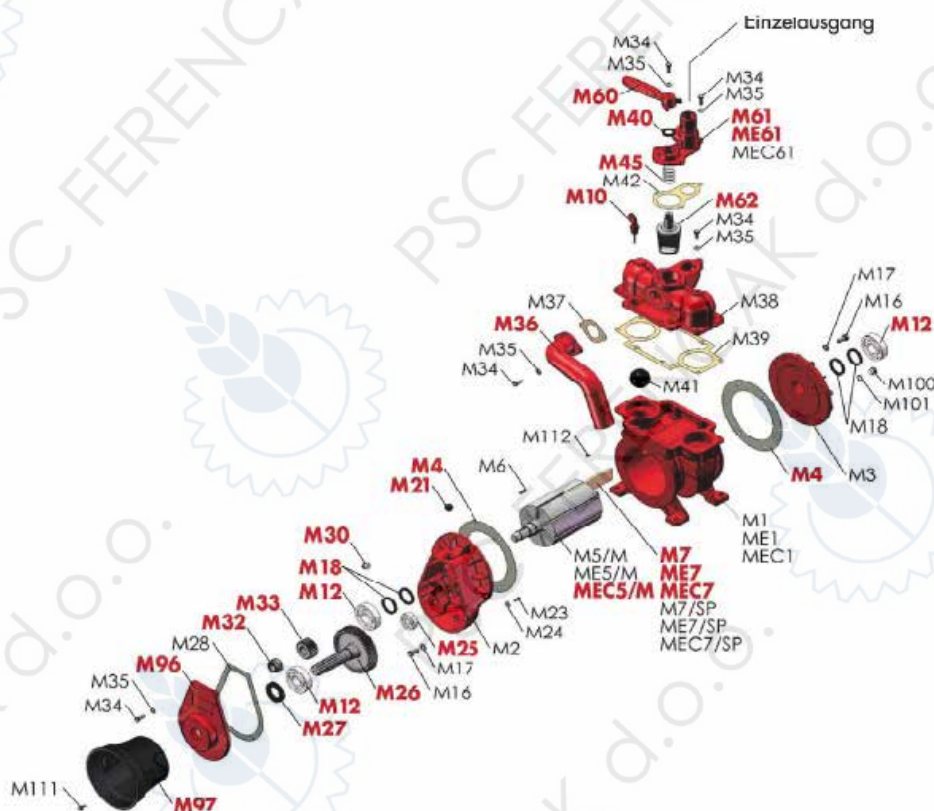

Rb.	ŠIFRA	POZICIJA NA SKICI	NAZIV	OPIS
1	Po narudžbi	MEC5/M	ROTOR PUMPE	ZA MEC 4000/M
2	Po narudžbi	M7	LAMELA	ZA MEC 2000/M
3	191389	MEC7	LAMELA	ZA MEC 3000/M
4	196908	MEC7	LAMELA	ZA MEC 4000/M
5	202073	M4	BRTVA	ZA MEC 2000-4000/M
6	Po narudžbi	M97	PVC ZAŠTITA	ZA MEC 2000-4000/M
7	Po narudžbi	M10	MJERAČ ULJA	ZA MEC 2000-4000/M
8	1196114	M21	ČEP ULJA	ZA MEC 2000-4000/M
9	Po narudžbi	M26	ZUPČANIK	ZA MEC 2000-4000/M
10	Po narudžbi	M30	KONTROLNI ČEP	ZA MEC 2000-4000/M
11	Po narudžbi	M32	MATICA	ZA MEC 2000-4000/M
12	Po narudžbi	M33	ZUPČANIK	ZA MEC 2000-4000/M
13	Po narudžbi	M36	KOLJENO	ZA MEC 2000-4000/M
14	202056	M41	GUMENA KUGLA	ZA MEC 2000-4000/M
15	Po narudžbi	M60	RUČKA BATA	ZA MEC 2000-4000/M
16	Po narudžbi	M61	PRIKLJUČAK CRIJEVA 45mm	ZA MEC 2000-4000/M
17	Po narudžbi	ME61	PRIKLJUČAK CRIJEVA 60mm	ZA MEC 2000-4000/M
18	Po narudžbi	M45	OPRUGA	ZA MEC 2000-4000/M
19	197828	M62	BAT PUMPE	ZA MEC 2000-4000/M
20	Po narudžbi	M96	POKLOPAC KUČIŠTA	ZA MEC 2000-4000/M
21	Po narudžbi	M40	BRTVA BATA	ZA MEC 2000-4000/M
22	Po narudžbi	M27	BRTVA VRATILA	ZA MEC 2000-4000/M
23	Po narudžbi	M18	BRTVA VRATILA	ZA MEC 2000-4000/M
24	198927	M25	LEŽAJ	ZA MEC 2000-4000/M
25	198930	M12	LEŽAJ	ZA MEC 2000-4000/M
26	201143	M42	DIHTUNG BATA	ZA MEC 2000-4000/M



DIJELOVI VAKUUM PUMPE MEC 5000 - 8000 / M000 / M

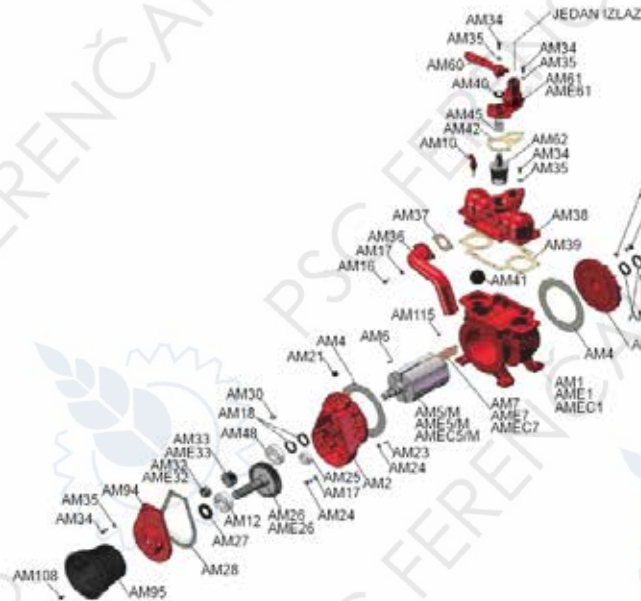

7

Rb.	ŠIFRA	POZICIJA NA SKICI	NAZIV	OPIS
1	Po narudžbi	AM5/M	ROTOR PUMPE	ZA MEC 5000/M
2	Po narudžbi	AMEC5/M	ROTOR PUMPE	ZA MEC 6500/M
3	Po narudžbi	AME5/M	ROTOR PUMPE	ZA MEC 8000/M
4	193384	AM7	LAMELA	ZA MEC 5000/M
5	193385	AMEC7	LAMELA	ZA MEC 6500/M
6	193386	AME7	LAMELA	ZA MEC 8000/M
7	202072	AME7(org)	LAMELA	ZA MEC 5000-8000/M
8	197988	AM4	BRTVA PUMPE	ZA MEC 5000-8000/M
9	Po narudžbi	AM10	MJERAČ ULJA	ZA MEC 5000-8000/M
10	196114	AM21	ČEP ULJA	ZA MEC 5000-8000/M
11	Po narudžbi	AM26	ZUPČANIK	ZA MEC 5000/M
12	Po narudžbi	AME26	ZUPČANIK	ZA MEC 6500-8000/
13	Po narudžbi	AM30	KONTROLNI ČEP	ZA MEC 5000-8000/M
14	Po narudžbi	AM32	MATICA	ZA MEC 5000-8000/M
15	Po narudžbi	AME32	MATICA	ZA MEC 5000-8000/M
16	Po narudžbi	AM33	ZUPČANIK	ZA MEC 5000/M
17	Po narudžbi	AME33	ZUPČANIK	ZA MEC 6500-8000/M
18	Po narudžbi	AM36	KOLJENO	ZA MEC 5000-8000/M
19	Po narudžbi	AM41	GUMENA KUGLA	ZA MEC 5000-8000/M
20	201142	AM60	RUČKA BATA	ZA MEC 5000-8000/M
21	202586	AME61	PRIKLJUČAK CRIJEVA 80mm	ZA MEC 5000-8000/M
22	Po narudžbi	AM45	OPRUGA	ZA MEC 5000-8000/M
23	197873	AM62	BAT PUMPE	ZA MEC 5000-8000/M
24	Po narudžbi	AM94	POKLOPAC KUČIŠTA	ZA MEC 5000-8000/M
25	Po narudžbi	AM40	BRTVA BATA	ZA MEC 5000-8000/M
26	Po narudžbi	AM27	BRTVA VRATILA	ZA MEC 5000-8000/M
27	Po narudžbi	AM18	BRTVA	ZA MEC 5000-8000/M
28	198922	AM48	LEŽAJ	ZA MEC 5000-8000/M
29	198927	AM25	LEŽAJ	ZA MEC 5000-8000/M
30	198930	AM12	LEŽAJ	ZA MEC 5000-8000/M
31	202602	AM29	POKLOPAC KUČIŠTA	ZA MEC 5000-8000/M
32	202601	AM2	KUČIŠTE GETRIBE	ZA MEC 5000-8000/M
33	200359	AM28	BRTVA PUMPE	ZA MEC 5000-8000/M
34	200362	AM39	BRTVA PUMPE	ZA MEC 5000-8000/M
35	200363	AM42	BRTVA PUMPE	ZA MEC 5000-8000/M

**LAMELE ZA VAKUUM PUMPE**

Rb	ŠIFRA	MODEL PUMPE	L (mm)	B (mm)	S (mm)	LAMELA U PUMPI
1	200035	MEC2000/M	180	41	6,5	7
2	200037	E10/EL60	200	60	10	4
3	200036	TK/0 5000	200	75	10	4
4	030021	DKP-3 CREINA	215	33	4	4
5	200033	ES1/4	215	35	6	7
6	200040	PN33 JUROP	223,7	64,5	7,5	3
7	191389	MEC 3000/M	240	41	6,5	7
8	194886		240	57	7,5	-
9	194702	KD 6500 HERTELL	240	64	7,5	-
10	203009		245	60	8	-
11	199726	RF27-4 OCHSNER	270	35	5,7	4
12	200038	E11/EL80	270	60	10	4
13	198418	TK/1 7000	270	75	10	4
14	200029	SE6500	280	60	7,5	6
15	030024	DKP-4 CREINA	300	33	4	4
16	200034	ES2/5, ES5/6	300	41	6	7
17	191390	ES6/9, KRONE 10000	360	52	8	7
18	196908	MEC 4000/M	300	41	6,5	7
19	200044	JOBA P10	300	45	6	7
20	193384	MEC 5000/M	300	46,5	6,5	7
21	203608		320	35	5,7	-
22	196854	SE8000	330	60	7,5	6
23	100069	TK/2 9000	340	75	10	4
24	200043	M10	345	60	8	4
25	191180	SE10000, STAR60	350	70	7,5	6
26	200041	PN84 JUROP	353,7	59,5	7,5	4
27	194701	KD 10000 HERTELL	360	64	7,5	-
28	193385	MEC 6500/M	370	46,5	6,5	7
29	197596		370	46,5	6,3	-
30	200039	E13/EL120	400	60	10	4
31	194885	SE12000, STAR72	400	70	7,5	6
32	200031	WPT600	400	73,5	7,5	6
33	200042	PN106 JUROP	442,5	59,5	9,05	4
34	199878		443,6	59,5	9	
35	196116		450	46,5	6,3	
36	193386	MEC 8000/M	450	46,5	6,5	7
37	202072		450	46,5	6,5	
38	192539	DKP-8 CREINA	455	59,5	7,5	-
39	200030	STAR84	480	70	7,5	6
40	200032	WPT720	500	73,5	7,5	6



SIGURNOSNI VENTILI

ŠIFRA	DN	D mm	H mm	L mm
195750	1 1/4"	40	170	89
195478	1 1/2"	45	180	100
195195	2"	51	160	110

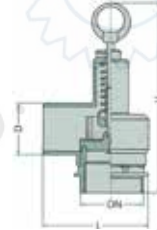

ŠIFRA NAZIV

195816 Ventil sigurnosni tlačni 1 1/2"

200109 Ventil sigurnosni 1



ŠIFRA NAZIV

201004 Ventil sigurnosni usisni 1 1/2"



030028 Kapaljka ulja
200112



197991 Set brtvi za pumpe B.P.

197992 STAR 60
197993 STAR 72
197994 STAR 84
197990 SE 1000



7

USISNO CRIJEVO APPOLO PLASTIČNA SPIRALA



Svjetloplava boja sa ekstrudiranim crvenim trakama.

Podnosi temperature:

-25°C- +60°C

Ugrađena PVC spirala.

Podnosi vakuum do 0,9 bar

ŠIFRA	UNUTARNJI PRMJER U mm	UNUTARNJI PROMJER U COLIMA (")	DEBLJINA STJENKE U mm	TEŽINA g/m	RADNI TLAK bar	DUŽINA KOLUTA
197634	45	-	-	-	-	max. 50m
010434	50	2"	5,5	1150	5	max. 50m
010435	60	2 3/8"	5,6	1350	4,5	max. 50m
197980	75	3"	6,5	1700	4	max. 30m
196183	80	3 1/8"	6,5	1850	3,5	max. 30m
-	90	3 1/2"	6,7	2250	3,5	max. 30m
010437	102	4"	7,3	2700	3	max. 30m
192175	110	4 1/4"	7,5	3100	3	max. 20m
030057	120	4 3/4"	8	3600	2,5	max. 20m
190845	127	5"	8,3	3900	2,5	max. 20m
196361	133	5 1/4"	8,5	4200	2,5	max. 20m
030056	152	6"	9	5000	2	max. 20m
197579	160	6 1/2"	9,4	5600	2	max. 20m
197313	200	8"	13	10000	1,2	max. 20m

**USISNO CRIJEVO ATOSICO PLASTIČNA SPIRALA**

Zelena sa ugrađenom bijelom spiralom. Otporna na kemikalije i lagana.

Temperatura primjene:

-5°C - +60°C

Ugrađena tvrda PVC spirala.

ŠIFRA	UNUTARNJI PROMJER mm	UNUTARNJI PROMJER COLI (")	DEBLJINA STJENKE mm	TEŽINA g/m	RADNI TLAK bar	DUŽINA KOLUTA
010429	20	3/4	2,4	240	7	max. 50m
010370	25	1	3,3	330	7	max. 50m
010431	30	1 3/16	-	-	7	max. 50m
010233	32	1 1/4	3,6	460	7	max. 50m
010432	35	1 3/8	3,4	500	6	max. 50m
010433	40	-	3,8	610	6	max. 50m
194482	45	1 3/4	3,7	670	5	max. 50m
197635	50	2	4,1	810	5	max. 50m
193098	60	2 3/8	4,5	970	5	max. 50m
010288	75	3	-	1400	4	max. 50m
010436	80	3 1/4	-	-	4	max. 50m
030002	100	4	-	2100	4	max. 30m
193325	110	-	-	-	-	max. 30m
191123	120	5	-	-	-	max. 30m
195027	150	6	-	-	-	max. 20m

USISNO CRIJEVO GUMENO ČELIČNA SPIRALA

ŠIFRA	UNUTARNJI PROMJER mm	UNUTARNJI PROMJER U COLI (")	DEBLJINA STJENKE mm	TEŽINA g/m	RADNI TLAK bar	DUŽINA (m)
030074	102	4	8	8000	3	2
196715	102	4	8	11200	3	3
195814	110	4	8	13400	3	3
190507	120	4 1/4	8	12100	3	2
195819	120	4 1/4	8	17700	3	3
198794	120	4 3/4	8	23300	3	3
198031	125	5	8	14500	3	3
199341	125	5	8	20600	3	4
195692	133	5 1/4	9	27900	3	2
190530	150	6	9	14500	3	2
197897	150	6	9	25100	3	3
198897	159	6 1/4	10	18200	3	2
190756	159	6 1/4	10	27100	3	3



OBUJMICE ZA CRIJEVA



ŠIFRA	RASPON mm	ŠIRINA mm
195828	32 - 35	18
195829	36 - 39	18
195696	40 - 43	18
195830	44 - 47	22
195831	48 - 51	22
196375	52 - 55	22
193388	56 - 59	22
195034	60 - 63	22
194182	64 - 67	22
195035	68 - 73	24
195036	74 - 79	24
193610	80 - 85	24

ŠIFRA	RASPON mm	ŠIRINA mm
195037	86 - 95	24
-	92 - 97	24
196408	98 - 103	24
-	104 - 112	24
030019	113 - 121	24
193326	122 - 130	24
190848	131 - 139	26
192819	140 - 148	26
190849	149 - 161	26
195038	162 - 174	26
193753	175 - 187	26
030082	214 - 226	26

7

NASTAVCI ZA CIJEVI

ŠIFRA	NAZIV
198105	Metalni završetak crijeva Ø100
201259	Metalni završetak crijeva Ø110
199572	Metalni završetak crijeva Ø125
198078	Metalni završetak crijeva Ø150
192156	Cijev limena cinčana Ø100x2000
030001	Cijev aluminijski Ø100x2000
191387	Cijev limena cinčana Ø120x2000
190615	Cijev limena cinčana Ø133x2000
191919	Cijev limena cinčana Ø150x2000 Ø150x3000



ŠIFRA	NAZIV
200027	Gumeno elastično grlo 6" ID=160 mm, H=154 mm
200028	Gumeno elastično grlo 8" ID=220 mm, H=195 mm
197816	Spojnicica crijeva Ø100
197817	Spojnicica crijeva Ø120
201258	Spojnicica crijeva Ø125
197872	Spojnicica crijeva Ø150



ZASUN MESINGANI 2x UNUTARNJI NAVOJ



ŠIFRA	ø"	ø mm	h	H	L	F
200092	4"	95	232	290	76	70
200093	5"	120	283	345	91	72
200094	6"	145	321	400	107,5	82

ZASUN MESINGANI NAVOJ - PRIRUBNICA



ŠIFRA	ø"	ø mm	h	H	L	L1	d	l	F
194606	5"	120	290	345	180	91	13	150	72
192109	6"	145	327	400	180	107,5	13	150	82



ZASUN MESINGANI SA DVIJE PRIRUBNICE

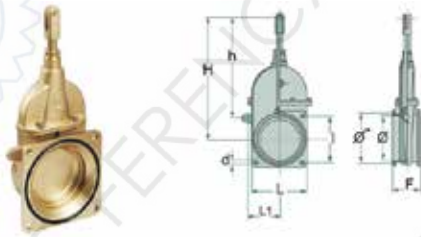

ŠIFRA	ø"	ø mm	h	H	L	L1	d	l	F
192467	4"	95	236	290	180	96	13	150	90
198037	5"	120	290	345	180	97	13	150	90
195445	6"	145	324	400	180	107,5	13	150	90

OSTALI DIJELOVI ZA CISTERNU

ŠIFRA	NAZIV	Image
194692	Vrh zasuna za modele: 4", 5", 6" M30x2	
197821	Matica osovine zasuna za: 4", 5", 6" M30x2	
190653	PVC oring osovine zasuna	
199803 200070 201309 190650 199804	Kapa zasuna 4" MZ Kapa zasuna 4" RIV Kapa zasuna 5" RIV Kapa zasuna 6" MZ Kapa zasuna 6" RIV	
	Osovina za otvaranje	
192185 199819 199820	za 4" L=190 mm za 5" L=230 mm za 6" L=255 mm	
198595 199392 200407 199393 196639	Vrata zasuna 4" RIV Vrata zasuna 5" RIV Vrata zasuna 6" MZ L-tip Vrata zasuna 6" MZ T-tip Vrata zasuna 6" RIV	
200118 200119 100548 192849	Brtva 4" RIV Brtva 5" RIV Brtva 6" RIV Brtva 6" MZ	

OSTALI DIJELOVI ZA CISTERNU







ŠIFRA	NAZIV	Image
070025	Brtva gumena za priрубnicu 150x150x6 mm	
190714	Brtva gumena za priрубnicu 4", 5", 6"	
197258	Mehanizam za otvaranje zasuna 4", 5", 6"	
200106	Mehanizam za otvaranje zasuna 4", 5", 6"	
197452	Matica sa mazalicom (montira se prilikom ugradnje mehanizma 197258)	
193414 199421 196720	Cilindar za otvaranje zasuna hidraulični RIV 4" 5" 6"	
193414 199421 196720	Plinski ublaživač za cilindar 4" 5" 6"	
	Hidraulično crijevo sa priključkom za cilindar L=3,5 m L=4 m L=5 m L=6 m L=7 m L=8 m L=9 m L=10 m NAPOMENA: Izrađujemo po narudžbi	
197601	Uljna pumpa za MEC 5000-8000	
200939	Uljna pumpa za MEC 2000-8000	
	Sakupljač taloga PVC kpl	
200111 201308 196940 200110	ID= Ø50 mm RIV ID= Ø60 mm RIV ID= Ø75 mm RIV ID= Ø80 mm RIV	
194843	Posuda sakupljača taloga PVC RIV	



OSTALI DIJELOVI ZA CISTERNU

ŠIFRA	NAZIV	
030034 194458	Sakupljač taloga aluminijski ID= Ø44 mm ID= Ø60 mm	
195082	Posuda sakupljača taloga PVC za aluminijski model	
030018	Podloška matice posude sakupljača taloga	
030020 100382	Matica posude sakupljača taloga Matica posude sakupljača taloga kpl	
196157	Posuda sakupljača taloga PVC Gumica	
030063	Posuda sakupljača taloga PVC Gumica	
201149 030012 194459 201148	Kugla PVC Ø100 mm Kugla PVC Ø120 mm Kugla PVC Ø150 mm Kugla PVC Ø200 mm	

OSTALI DIJELOVI ZA CISTERNU

ŠIFRA	NAZIV	
202056 030022 030025 198645 199049	Kugla gumena Ø55 mm Kugla gumena Ø60 mm Kugla gumena Ø70 mm Kugla gumena Ø80 mm Kugla gumena Ø100 mm	
200115 192249 197719	Kontrolno oko 2" Kontrolno oko 2 1/2" Kontrolno oko 3"	
192822 198028	Priključak kontrolnog oka: Ø2" - H=20 mm Ø3" - H=25 mm	
198717 198718 198719	Kontrolno oko za kontrolu razine ulja: 3/8" 1/2" 3/4"	
194805 191994	Mano-vakuum metar: Ø60 mm navoj 1/4" Ø80 mm navoj 3/4" Ø100 mm navoj 1/2"	
	Mano-vakuum metar: Ø60 mm navoj 1/4" original CREINA	

7



O svim novim proizvodima se informirajte na našoj web stranici

www.psc-ferencak.hr



PRIKLJUČCI ZA CISTERNE - SISTEMI BRZOG KOPČANJA

Kod priključaka za cisterne se koristi nekoliko različitih sistema brzog kopčanja koji se međusobno razlikuju oblikom poluga za kopčanje i odgovarajućeg priključka. Najčešći sistemi brzog kopčanja su: **talijanski, Bauer, Perrot i vatrogasni (Storz)**. Izgled spomenutih priključaka prikazan je na slikama.

SI. 1. TALIJANSKI SISTEM

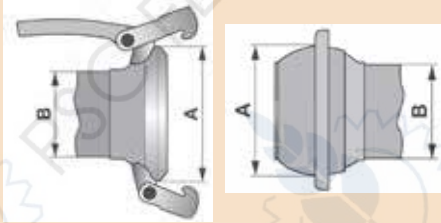

SI. 2. BAUER SISTEM

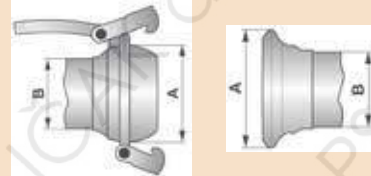

SI. 3. PERROT SISTEM

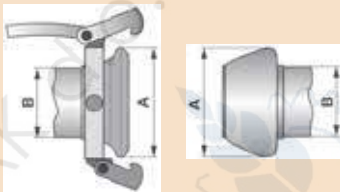

SI. 4. VATROGASNI SISTEM (STORZ)

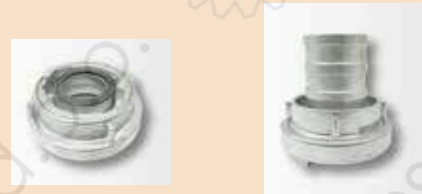

PREGLED DIMENZIJA I OZNAKA PRIKLJUČAKA

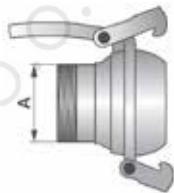

Kopča s navojem



Kopča bez navoja

Promjer coli (")	Promjer A (mm)	Promjer B (mm)	Talijanski sistem (SI. 1)	Bauer sistem (SI. 2.)	Perrot sistem (SI. 3.)
1/2"	21	-	-	-	-
3/4"	26,4	-	-	-	-
1"	33,3	-	-	-	-
1 1/4"	41,9	-	-	-	-
1 1/2"	47,8	-	-	-	-
2"	59,6	-	60	HK50	-
2 1/2"	75,2	-	-	-	-
3"	87,9	-	80	HK76	70
3 1/2"	100,3	-	-	HK89	89
4"	113	100	100	HK108	108
4 1/4"	-	108	-	-	-
4 3/4"	-	120	-	-	-
5"	138	125	120	HK133	133
5 1/4"	-	133	-	-	-
6"	164	150	150	HK159	159
6 1/4"	-	159	-	-	-
8"	-	200	200	HK194	216



TALIJANSKI SISTEM

Dimenzije spojnica

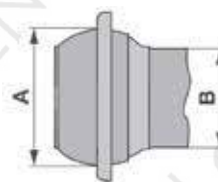

NAZIVNA MJERA	MJERA A (mm)	MJERA B (mm)
60	92	53
80	112	73
100	131	93
108	141	105
120	152	110
150	181	138

NAZIVNA MJERA	MJERA A (mm)	MJERA B (mm)
60	90	53
80	111	73
100	129	93
108	140	105
120	149	110
150	180	138

7

ZADNJI PRIKLJUČAK S NAVOJEM (cinčani)

ŠIFRA	NW(mm)	A (")	B (mm)
-	100	2 1/2"	130
030037	100	4"	130
196381	120	4"	150
-	120	2"	150
-	120	2 1/2"	150
190851	120	5"	150
-	150	2"	180
-	150	2 1/2"	180
-	150	4"	180
195967	150	5"	180
192660	150	6"	180

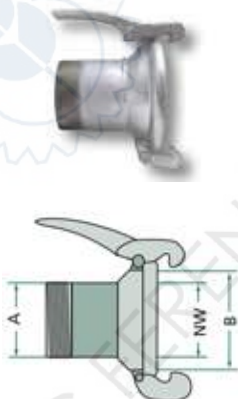

ZADNJI PRIKLJUČAK S PRIRUBNICOM (cinčani)

ŠIFRA	OPIS	NW (mm)	B (mm)	LA (mm)
193387	PRIKLJUČAK 4"	100	130	150x150
-	PRIKLJUČAK 5"	120	150	150x150
197126	PRIKLJUČAK 6"	150	180	150x150
-	PRIKLJUČAK 8"	200	243	180x180



SPOJKA -A- ZA CRIJEVO (cinčana)

ŠIFRA	NW (mm)	A (mm)	B (mm)
030036	100	100	130
-	100	110	130
-	120	100	150
190850	120	120	150
-	120	125	150
-	120	133	150
-	150	100	180
-	150	120	180
191374	150	150	180
-	150	159	180
-	200	200	243

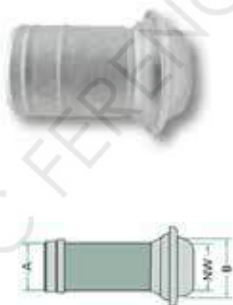

SPOJKA -B- ZA CRIJEVO (cinčana)

ŠIFRA	NW (mm)	A (mm)	B (mm)
030035	100	100	130
-	100	110	130
-	120	100	150
192659	120	120	150
-	120	125	150
-	150	100	180
-	150	120	180
-	150	125	180
192379	150	150	180
-	150	159	180

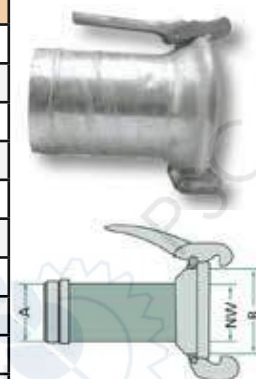



TALIJANSKI SISTEM

SPOJKA -A- S PRIRUBNICOM (cinčana)

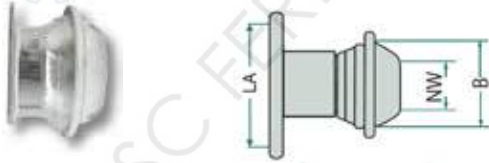

SPOJKA -A- S NAVOJEM (cinčana)



ŠIFRA	OPIS	NW (mm)	B (mm)	LA (mm)
203122	PRIKLJUČAK 4"	100	130	150x150
193387	PRIKLJUČAK 5"	120	150	150x150
197126	PRIKLJUČAK 6"	150	180	150x150
-	PRIKLJUČAK 8"	200	243	180x180

ŠIFRA	NW (mm)	A (")	B (mm)
-	100	2 1/2"	130
195032	100	4"	130
-	120	2"	150
-	120	4"	150
193324	120	5"	150
-	150	2"	180
-	150	2 1/2"	180
-	150	4"	180
197583	150	5"	180
195033	150	6"	180

REDUKCIJA SPOJKE -A- VEĆE NA SPOJKU -B- MANJU



REDUKCIJA SPOJKE -A- MANJE NA SPOJKU -B- VEĆU



ŠIFRA	OPIS	A (mm)	B (mm)
-	5"A na 4"B	120	100
192217	6"A na 4"B	150	100
199797	6"A na 5"B	150	120
198107	8"A na 6"B	200	150

ŠIFRA	OPIS	A (mm)	B (mm)
-	4"A na 5"B	100	120
-	4"A na 6"B	100	150
-	5"A na 6"B	120	150
-	6"A na 8"B	150	200

KOLJENO 90°

GUMENA BRTVA ZA SPOJKE

ŠIFRA NAZIV

- 030039 Koljeno 90° 4" (100 mm)
- 192821 Koljeno 90° 5" (120 mm)
- 194003 Koljeno 90° 6" (150 mm)
- Koljeno 90° 8" (200 mm)



ŠIFRA	OPIS	A (mm)	B (mm)
030072	4"	110	140
030047	1 3/4"	120	140
190854	5"	140	170
191375	6"	180	210
197581	8"	250	280





TALIJANSKI SISTEM

ŠIFRA	NAZIV		ŠIFRA	NAZIV	
200045	Sistem brzog kopčanja za model 6" talijanski sistem				
	Kugla spojke talijanski sistem:		198356	4" ; 110 mm	
194171	4" A= 100 mm; B= 130 mm		198724	5" ; 120 mm	
199253	5" A= 120 mm; B= 150 mm		198725	6" ; 150 mm	
198355	6" A= 150 mm; B= 180 mm 8" A= 200 mm; B= 240 mm				
	Obruč kugle talijanski sistem:				
030042	4"				
190852	5"		202886	4"	
190853	6"		202887	5"	
	8"		202888	6"	
	Priključak s navojem:				
030073	4" L= 70 mm		196465	4" (100 mm)	
199592	4" L= 150 mm		191931	5" (120 mm)	
198715	5" L= 150 mm		191929	6" (150 mm)	
192820	6" L= 150 mm				
	Metalni tuljak Konus 165x100x50 Konus 165x115x55 Konus 165x150x50		193265	4" (100 mm)	
			194165	5" (120 mm)	
			-----	6" (150 mm)	
	Kopče spojke		193466	Disk raspršivača	
201403	ø100 mm				
202198	ø120 mm				
201404	ø150 mm				
202098	ø200 mm				
197303	Vilica za priključak cisterne KPL				
	Priključak sa prirubnicom				
197994	4"				
197995	5"		197813	120 mm	
197996	6"		198029	133 mm	
	L0 150 mm, 150x150 mm		197814	166 mm	
030045	Betva zadnjeg poklopca cisterne Creina		199235	Cink spray (za popravak manjih oštećenja na pocinčanim dijelovima)	



PERROT SISTEM

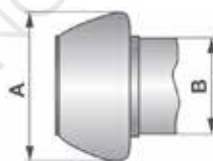
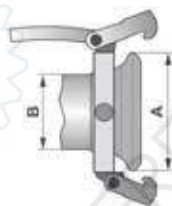

NAZIVNA MJERA	MJERA A (mm)	MJERA B (mm)
50	85	50
70	108	70
89	136	89
108	161	108
133	188	133
159	223	159

NAZIVNA MJERA	MJERA A (mm)	MJERA B (mm)
50	76	50
70	103	70
89	133	89
108	154	108
133	179	133
159	210	159

SPOJKA -A- ZA CRIJEVO PERROT (cinčano)

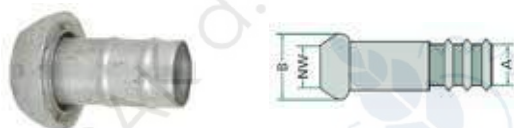

ŠIFRA	NW mm	A mm	B mm
-	108	100	155,5
-	108	125	155,5
-	108	150	155,5
203945	133	100	179
200071	133	125	179
198644	133	133	179
-	133	150	179
199798	159	100	211
-	159	125	211
-	159	133	211
203030	159	150	211
190316	159	159	211

SPOJKA -B- ZA CRIJEVO PERROT (cinčano)



ŠIFRA	NW mm	A mm	B mm
202937	89	90	126
199438	108	100	145,5
-	108	125	145,5
-	108	150	145,5
199436	133	100	171,5
-	133	125	171,5
-	133	133	171,5
-	133	150	171,5
198596	159	100	203,5
-	159	125	203,5
-	159	133	203,5
-	159	150	203,5
198609	159	159	203,5

GUMENA BRTVA ZA SPOJKE PERROT

ŠIFRA	OPIS	B (mm)	S (mm)
202936	3"	110	13
192257	4"	124	18
198867	5"	139	22
203432	6"	178	22
	8"	255	24

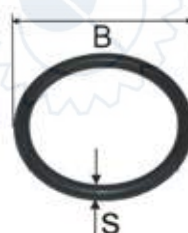



PERROT SISTEM

ŠIFRA NAZIV

199760 Sistem brzog kopčanja za model 6" Perrot sistem



ŠIFRA NAZIV

202741 Spojka Perrot s navojem
199437 108/3"
159/6"



198868 Priključak zadnji sa ručkama Perrot 133/5"



7

BAUER SISTEM

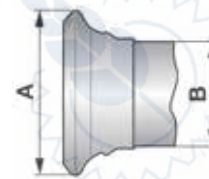

NAZIVNA MJERA	MJERA A (mm)	MJERA B (mm)
HK50	70	49
HK76	98	76
HK89	120	89
HK108	145	108
HK133	159	132
HK159	180	158
HK194	230	194

NAZIVNA MJERA	MJERA A (mm)	MJERA B (mm)
HK50	70	49
HK76	98	76
HK89	120	89
HK108	145	108
HK133	159	132
HK159	180	158
HK194	230	194

PRIKLJUČAK ZADNJI BAUER



ŠIFRA	NW (mm)	A (mm)	B (mm)
192700	108	114,5	148
197458	133	139,7	163
192184	159	165,1	182

KUGLA SPOJKE BAUER

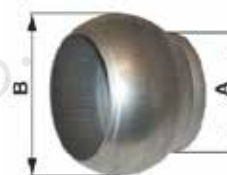

ŠIFRA	NW (") mm	B ø mm
199357	4" 108	145
200211	5" 133	159
199739	6" 159	179

GUMENA BRTVA SPOJKE BAUER

ŠIFRA	OPIS	B (mm)	S (mm)
197998	4"	165	15
204081	5"	190	18
204275	6"	208	19





VATROGASNI PRIKLJUČCI ZA CISTERNE (STORZ)

SPOJKA "B" SA VATROGASNIM PRIKLJUČKOM



ŠIFRA	OPIS	ø mm	VATROGASNI PRIKLJUČAK
-	6"	150	C
196753	4"	100	B
197210	5"	120	B
197125	6"	150	B
-	4"	100	A
-	5"	120	A
-	6"	150	A

SPOJKA "A" SA VATROGASNIM PRIKLJUČKOM



ŠIFRA	OPIS	ø mm	VATROGASNI PRIKLJUČAK
196711	6"	150	C
196684	4"	100	B
196714	5"	120	B
196934	6"	150	B
-	4"	100	A
-	5"	120	A
-	6"	150	A
196685	4"	100	C
196686	5"	120	C

VATROGASNI PRIKLJUČAK ZA CRIJEVO

ŠIFRA NAZIV

Priključak vatrogasni "A" za crijevo:

- 198295 S= ø 100 mm
- 198526 S= ø 110 mm



VATROGASNI PRIKLJUČAK ZA CRIJEVO

ŠIFRA NAZIV

Priključak vatrogasni "D" za crijevo:

- 197815 S= ø 25 mm

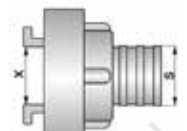

Priključak vatrogasni "B" za crijevo:

- 196936 S= ø 75 mm



Priključak vatrogasni "C" za crijevo:

- 199364 S= ø 40 mm
- 199363 S= ø 45 mm
- 197453 S= ø 52 mm

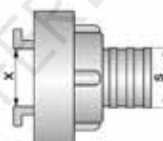

VATROGASNI PRIKLJUČAK S NAVOJEM

Priključak vatrogasni s unutarnjim navojem:

- 197391 A na 4" navoj
- 198898 B na 3" navoj
- 198892 B na 2" navoj
- 200400 B na 2 1/2" navoj
- 198899 C na 2" navoj



VATROGASNA REDUKCIJA

Redukcija vatrogasna

- 197306 B na C
- 197392 A na B





Prostor za bilješke

PSC ferencak











**RASIPAČI MINERALNIH
GNOJIVA**

DIJELOVI RASIPAČA AGREX	102
DIJELOVI RASIPAČA AMAZONE	102-103
DIJELOVI RASIPAČA BOGBALLE	103
DIJELOVI RASIPAČA RAUCH	104
DIJELOVI RASIPAČA VICON	105-108





RASIPAČ MINERALNIH GNOJIVA - AGREX





ŠIFRA	NAZIV	KAT.BR.	ŠIFRA	NAZIV	KAT.BR.
191742	Ploča regulacije rasipača		191820	Disk rasipača KPL	
192212	Ručka regulacije rasipača		191680	Lopatica rasipača SF	
191819	Mješalica rasipača		100482	Getriba rasipača SF/SL	
			100013	Rasipač SF 300	
			100119	Rasipač SF 400	
			100014	Rasipač SF 500	

RASIPAČ MINERALNIH GNOJIVA - AMAZONE



ŠIFRA	NAZIV	ŠIFRA	NAZIV
205658	Rasipač mineralnih gnojiva ACH-2000L	205656	Rasipač mineralnih gnojiva ADH-1100L
205657	Rasipač mineralnih gnojiva ADH-1400L	205655	Rasipač mineralnih gnojiva AIG 800L s klatećom cijevi
205654	Rasipač mineralnih gnojiva AIP 500 L s klatećom cijevi	205659	Rasipač mineralnih gnojiva KOPA-1500 L s ceradom
205084	Lopatice rasipača Amazone 10-18 m set	205074	Lopatica rasipača Amazone 130 D
205075	Lopatica rasipača Amazone 130 L	205076	Lopatica rasipača Amazone 170 D



RASIPAČ MINERALNIH GNOJIVA - AMAZONE

ŠIFRA	NAZIV	ŠIFRA	NAZIV
205077	Lopatica rasipača Amazone 130 L 	205085	Lopatice rasipača Amazone 20-28 m set 
205079	Lopatica rasipača Amazone 215 L	205044	Lopatice rasipača Amazone 20-28 m set ECONOMY 
205068	Lopatica rasipača Amazone 215 L ECONOMY 	205078	Lopatica rasipača Amazone 215 D 
205082	Lopatica rasipača Amazone 260 D	205066	Lopatica rasipača Amazone 215 D ECONOMY 
205069	Lopatica rasipača Amazone 260 D ECONOMY 	205083	Lopatica rasipača Amazone 260 L 
202531	Lopatica rasipača Amazone 280 D 	205070	Lopatica rasipača Amazone 260 L ECONOMY 
205080	Lopatica rasipača Amazone 360 D	202530	Lopatica rasipača Amazone 280 L 
205072	Lopatica rasipača Amazone 360 D ECONOMY 	205081	Lopatica rasipača Amazone 360 L 
204726	Lopatice rasipača Amazone OM 18-24 hard coated set 	205073	Lopatica rasipača Amazone 260 D ECONOMY 
		205045	Lopatica rasipača Amazone za F/za FR set 

RASIPAČ MINERALNIH GNOJIVA - BOGBALLE

ŠIFRA	NAZIV	ŠIFRA	NAZIV
205062	Lopatice rasipača Bogballe 12-18 m set 	205064	Lopatice rasipača Bogballe 20-24 m set 
205065	Lopatice rasipača Bogballe 28-36 m set 		



RASIPAČ MINERALNIH GNOJIVA - RAUCH

200905 Lopatica rasipača ZSB duža D 3050169

200904 Lopatica rasipača ZSB duža L 3050071



197773 Disk rasipača L 4021052

197774 Disk rasipača D 4021053

197775 Disk rasipača L 4021109

197776 Disk rasipača L 4021110



197667 Lopatice rasipača KPL Axera D-3 0607034

197668 Lopatice rasipača KPL Axera D-4 0607035



8

Lopatice rasipača



ŠIFRA	DULJINA L	KAT.BR.	ZA MODELE
-------	-----------	---------	-----------

201242 L=170 mm 4087057

201243 L=240 mm 4087058

198156 L=170 mm 4087059 Axis: 20.1 30.1 40.1

198157 L=240 mm 4087060 Axis: 20.1 30.1 40.1

196858 L=200 mm 4087061 Axis: 20.1 30.1 40.1

196859 L=270 mm 4087062 Axis: 20.1 30.1 40.1

196860 L=270 mm 4087065 Axis: 20.1 30.1 40.1

196861 L=270 mm 4087089 Axis: 20.1 30.1 40.1

ŠIFRA	NAZIV	KAT.BR.	ZA MODELE
-------	-------	---------	-----------

197670 Lopatica rasipača 4021204 55, 65, 85, 701, 721, 732, 735, 801, 901, 921, 932, 935

197669 Lopatica rasipača 4021206 55, 65, 85, 701, 721, 732, 735, 801, 901, 921, 932, 935

197770 Lopatica rasipača 4021205 55, 65, 85, 701, 721, 732, 735, 801, 901, 921, 932, 935

197771 Lopatica rasipača 4021207 55, 65, 85, 701, 721, 732, 735, 801, 901, 921, 932, 935



RASIPAČ MINERALNIH GNOJIVA - VICON

ŠIFRA	NAZIV	KAT.BR.	ŠIFRA	NAZIV	KAT.BR.
110004	Klateća cijev stari tip original	VN17895466	196434	Obruč distančni bez vijka	VN90020041
196400	Klateća cijev stari tip zamjenska	VN90095965	110022	Obruč distančni s vijcima	
196403	Raspršivač klateće cijevi	VN17871016	110016	Donji dio regulatora	VN90015671
110037	Obruč klateće cijevi stari tip	VN90083262	196402	Donji dio regulatora zamjenski	330903
110001	Klateća cijev novi tip original	VN17896041	110017	Donji dio regulatora vučeni	VN90014311
100364	Klateća cijev novi tip zamjenska	330911	203614	Donji dio regulatora vučeni zamjenski	2422A
194673	Raspršivač klateće cijevi	VN79750039	190817	Pokrov zaštitni	VN90070589
030044	Obruč klateće cijevi novi tip	VN79220020	196401	Poklopac ležaja	VN97871180
110026	Ploča gornja original	VN90020020	110036	Spojka gumena	VN90070527
196405	Ploča gornja zamjenska	330906	203617	Spojka gumena zamjenska	
197513	Ploča gornja stari tip	VN79220016	110027	Sklopka gumena	VN46301001
			196404	Sklopka gumena zamjenska	330909
			190462	Ekscentar	VN79220029



RASIPAČ MINERALNIH GNOJIVA - VICON

ŠIFRA	NAZIV	KAT.BR.	ŠIFRA	NAZIV	KAT.BR.
110035	Ekscentar	VN97896442	110041	Prirubnica	VN19771374
					
100021	Ekscentar	VN90095936	198663	Prsten zaštitni	VN97871183
					
190823	Prsten ekscentra plastični	VN90070551	110043	Prirubnica ekscentra	VN90070590
					
110038	Prirubnica ekscentra	VN17895915	110028	Križ stari tip	VN90070550
					
190819	Pokrov zaštitni	VN90070633	195140	Zaštita PVC	VN17870495
					
110049	Poklopac PVC	VN90070164	195924	Ublaživač veći	VN17870985
					
195141	Poklopac PVC	VN90070552	195925	Ublaživač manji	VN17870986
					
110023	Križ ekscentra	VN97870897	110045	Opruga	VN90230079
					



RASIPAČ MINERALNIH GNOJIVA - VICON

ŠIFRA	NAZIV	KAT.BR.	ŠIFRA	NAZIV	KAT.BR.
110020	Ključ za regulaciju	VN90095926	110006	Vilica novi tip	VN79220024
					
198853	Zaštita ekscentra	VN98771245	193412	Čahura vilice	VN40231114
					
191991	Tuljak	VN90070532	110011	Mješač novi tip	VN90021406
			203616	Mješač novi tip zamjenski	VN90021406
					
198662	Prsten zaštitni	VN97871178	110033	Osovina lijka	VN97896422
					
190822	Plastika zaštitna	VN97871179	195136	Lopatica rasipača L=285 mm	VNB106002
			203619	Lopatica rasipača L=285 mm zamjenska	VNB456178
					
110010	Lijak PVC stari tip Kvarneland	VN90070442	195302	Lopatica rasipača L=185 mm	VNB1999002
			203623	Lopatica rasipača L=185 mm zamjenska	VNB4955978
					
193411	Lijak PVC novi tip ser. 219	VN17870553	110019	Regulator KPL	VN79220019
			203620	Regulator KPL zamjenski	VN79220019
					
110015	Lijak PVC novi tip Kverneland	VN90070632	110056	Getriba za PS rasipače	VN79760322
			203621	Getriba za PS rasipače zamjenska	APF-001
					



RASIPAČ MINERALNIH GNOJIVA - VICON

ŠIFRA	NAZIV	KAT.BR.	ŠIFRA	NAZIV	KAT.BR.
203622	Lopatica rasipača L=135 mm	VNB4955878	203618	Mješač gnojiva ST	
202543	Lopatica rasipača L=135 mm zamjenska	VNB4955878			
195137	Lopatica rasipača L=235 mm	VNB4956078	203626	Ležaj ekscentra ST	99196064
203624	Lopatica rasipača L=235 mm zamjenska	VNB4956178			

8

**Za sve priključne
strojeve se informirajte u
našim servisnim
centrima:**

**Križevci tel.: +385 48 681 902
fax.: +385 48 682 903**

**Koprivnica
tel./fax. +385 48 647 902**

**Bjelovar
tel./fax. +385 43 235 902**

**Virovitica
tel./fax. +385 33 728 902**

**Osijek
tel./fax. +385 31 211 902**



**Originalne ili zamjenske
dijelove za Vaše poljop-
rivredne strojeve potražite i
naručite u našim servisnim
centrima ili putem WEB
trgovine na adresi**

www.psc-ferencak.hr

**Upite ili narudžbe pošaljite na
e.mail**

info@psc-ferencak.hr



Prostor za bilješke

PSC ferencak



**Najnoviju ponudu dijelova potražite i kupite
putem naše WEB trgovine na adresi**

www.psc-ferencak.hr



**DIJELOVI ZA PRIKOLICE
STAJNJAKA**

KAJLE	112
LANCI	112
LANČANICI	113-114
PODLOŠKE	114
SPOJNICE LANCA	115
VIJCI I MATICE ZA PRIKOLICE STAJNJAKA	115



KAJLE ZA PRIKOLICE STAJNJAKA
KAJLA OBIČNA

ŠIFRA	b mm	h mm	L mm
050160	8	7	25
050033	8	7	30
191017	8	7	32
050017	8	7	40
050032	8	7	45
190999	8	7	50
070054	8	7	55
191031	8	7	63
191375	8	7	70
070055	10	8	40
050158	10	8	45
050146	10	8	60
193696	12	8	50

KAJLA ZUB

ŠIFRA	b mm	h mm	L mm
200775	8	7	60
202159	8	7	80
198065	10	8	60
198063	10	8	80
202659	12	8	100
198066	12	8	60
195072	12	8	80
198064	14	9	80

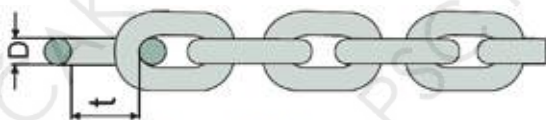
LANCI ZA PRIKOLICE STAJNJAKA
LANAC PODA

ŠIFRA	DIMENZIJA	D mm	t mm
192253	8x24	8	24
193537	8x31	8	31
195470	8x31 cinčani	8	31
196718	9x27	9	27
199172	9x31	9	31
198792	10x26,5	10	26,5
193538	10x31	10	31
197599	10x35	10	35
193442	11x31	11	31
197096	11x35	11	35
100314	13x45	13	45

LANAC PODA

ŠIFRA	DIMENZIJA	D mm	t mm
100399	6x59	6	59

LANAC PODA

ŠIFRA	DIMENZIJA	D mm	t mm
203929	12X80	12	80



LANČANICI ZA PRIKOLICE STAJNJAKA

LANČANIK PODA - TIP 1- OTVORENI

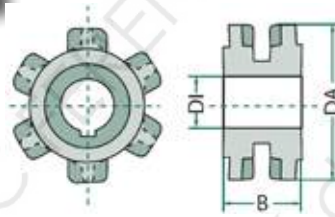

ŠIFRA	LANAC mm	DA mm	DI mm	KAJLA mm	B mm	BROJ UTORA
196756	11x31	140	40	12	68	6
198591	8x31	110	35	Bez	50	5
198446	9,5x26,2	120	35	10	60	6
198385	10x28	125	40	10	60	6
198035	11x31	135	40	12	62	6
090011	8x31	130	42	Bez	65	6
191191	8x31	110	35	10	70	5
010332	8x31	110	40	12	70	5
198386	10x31	110	40	12	70	5
198036	10x31	138	50	14	70	6
199183	11x31	135	45	14	67	6
198334	10x35	125	40	12	65	5
198585	10x35	145	45	14	75	6
070041	8x31	110	35	10	48	5
190357	8x31	100	40	12	48	5
070004	8x31	110	25	Bez	48	5
203924	8x31	110	30	Bez	48	5
200322	8x31	110	30	10	65	5
201201	8x31	130	35	10	65	6
202740	9,5x26,2	120	40	10	60	6
202487	10x31	110	35	10	70	5

LANČANIK PODA

ŠIFRA	LANAC mm	DA mm	DI mm	KAJLA mm	B mm	BROJ UTORA
201438	8x24	165	40	12	57	10



ŠIFRA	LANAC mm	DA mm	DI mm	KAJLA mm	B mm	BROJ UTORA
201389	8x24	140	40	12	60	8



ŠIFRA	LANAC mm	DA mm	DI mm	KAJLA mm	B mm	BROJ UTORA
203659	8x24	140	40	12	60	8





LANČANICI ZA PRIKOLICE STAJNJAKA

LANČANIK ZA LANAC PODA - TIP 1- ZATVORENI

ŠIFRA	LANAC mm	DA mm	DI mm	KAJLA mm	B mm	BROJ UTORA
197725	11x31	130	40	12	60	6
198341	8x31	135	40	12	50	6
198524	8x24	110	32	10	45	6
191183	9x31	130	35	10	50	6
198869	10x31	115	35	10	60	5
196745	10x31	115	40	10	60	5
198453	8x24	110	40	Bez	45	6
196667	8x31	110	40	Bez	48	6
202158	8x24	110	40	12	45	6
202769	8x31	135	40	12	50	6
203686	9x27	114	35	10	65	6
201998	10x31	110	30	Bez	51	5

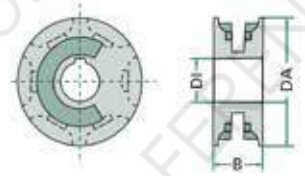

9

PODLOŠKE LANCA PODA I LETVE

ŠIFRA	NAZIV	ŠIFRA	NAZIV
197822	Podloška lanca poda Ø 8,5 mm za lance: 7x22 8x24	197627	Podloška lanca poda Ø 10,5 mm za lance: 10x31 10x35 11x31
197622	Podloška lanca poda Ø 10,5 mm za lance: 8x31 9x31	192361	Podloška lanca poda Ø 12,5 mm za lance: 8x31 9x31
199766	Podloška lanca poda Ø 10,5 mm za lance: 9x27 10x28	050110	Podloška lanca poda PVC Ø 10,5 mm za lance: 8x31
		195719	Letva poda prikolice (PRODAJE SE NA METRE)





SPOJNICE ZA LANAC PODA

ŠIFRA	DIMENZIJA	D mm	t mm
191989	8x24	8	24
194770	8x31//9x31	9	31
203689	9,5x27	9,5	27
192307	9x27	9	27
192370	10x28	10	28
050022	10x31//11x31	10	31
196719	10x35//11x35	11	35
195802	12x42	12	42
192298	13x36	13	36
100316	13x45	13	45

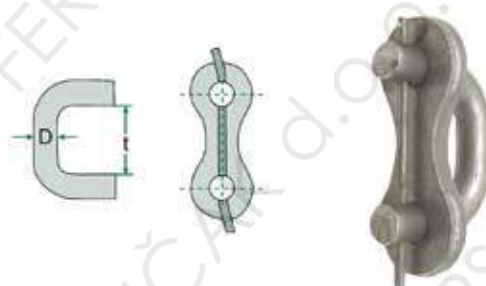

SPOJNICE ZA LANAC PODA

ŠIFRA	DIMENZIJA	G mm	H mm
201352	7x22	M8	37



9

VIJCI I MATICE ZA PRIKOLICE STAJNJAKA

ŠIFRA NAZIV

197881 T- vijak lanca poda M8
za lance:
7x22
8x24
9x27

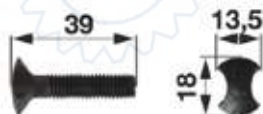

ŠIFRA NAZIV

100116 Matica sigurnosna M8

100386 Matica sigurnosna M10

100545 Matica sigurnosna M12



100138 T- vijak lanca poda M10
za lance:
8x31
9x31

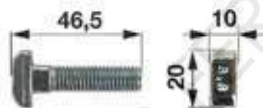

192299 T- vijak lanca poda M10
za lance:
9x31
10x31
11x31



196929 T- vijak lanca poda M10
za lance:
9x31
10x31
10x35
11x31



198034 T- vijak lanca poda M12
za lance:
11x35



202263 Vijak imbus M8x16
205086 Vijak imbus M8x20
198657 Vijak imbus M10x10
198658 Vijak imbus M10x12
202264 Vijak imbus M10x16
198659 Vijak imbus M12x12

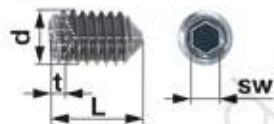



**DIJELOVI ZA PRSKALICE**

PUMPA BM 65-30 STD	118
PUMPA BM 65-30 P (ATOMIZER)	119
PROTOČNI REGULATOR A3	120
REGULATOR PR-3	121
REGULATOR PR-3 CENTRALNI DIO	122
VENTIL PR-1	123
VENTIL TROPOLNI	124
FILTER REGULATORA PR-3	125
VENTIL REGULATORA PR-3	125
MEMBRANE ZA PUMPE	126
DIZE TeeJet ZA PRSKALICE	127-134
OSTALI DIJELOVI ZA PRSKALICE	134-135
SERVIS PUMPI PRSKALICA	136





PUMPA BM 65-30 STD

BM 65-30 STD

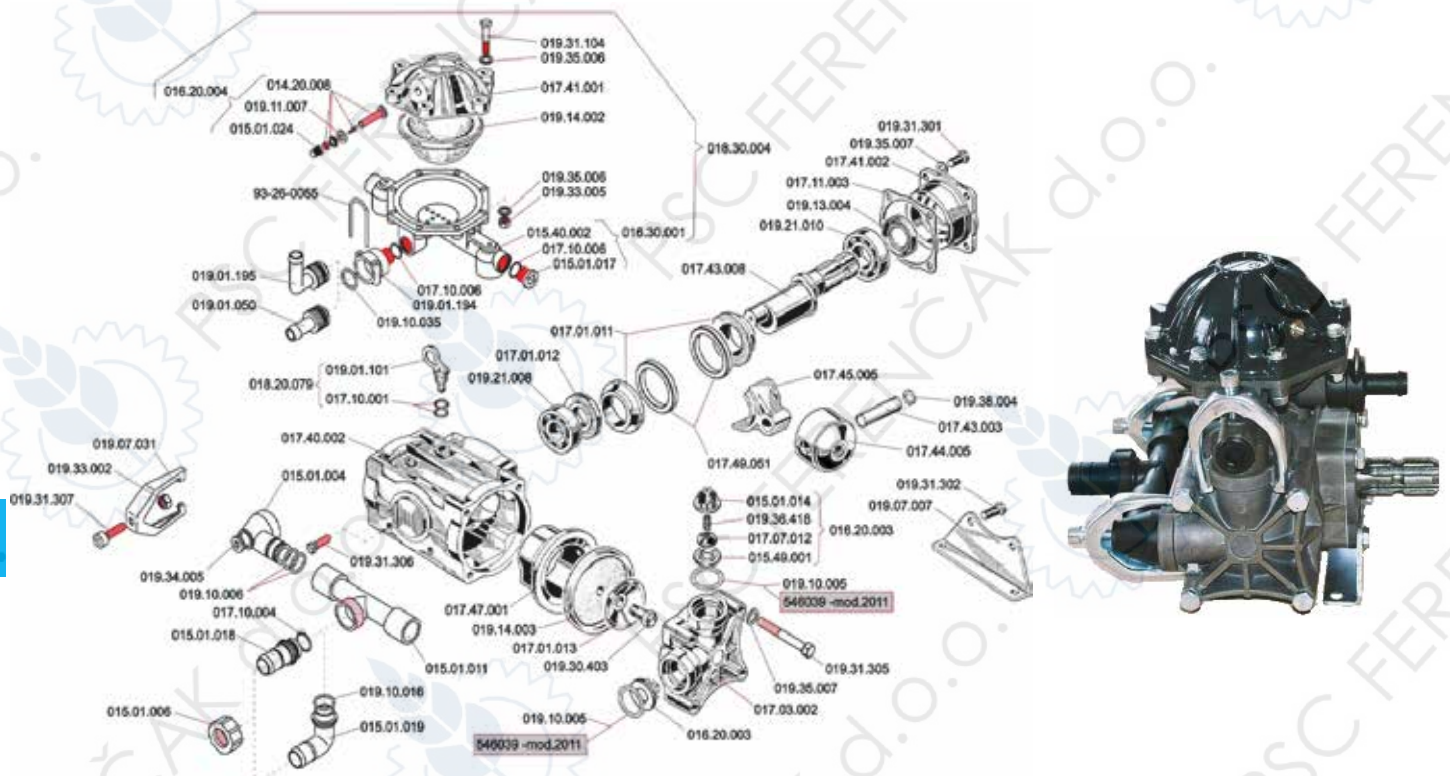

10

ŠIFRA	KAT. BROJ	NAZIV
010133	020.30.023	PUMPA 65/30
010056	018.30.004	VETRENICA
010009	016.20.004	VENTIL ZRAČNI ZA VETRENICU
010208	017.41.001	POKLOPAC VETRENICE
-	019.31.104	VIJAK VETRENICE
010093	019.14.002	MEMBRANA VETRENICE
010203	015.40.002	STALAK VETRENICE
-	017.10.006	GUMICA
010279	015.01.017	VIJAK VETRENICE
010079	019.10.006	GUMICA
190264	017.30.701	NASTAVAK PREDKOLJENA
010023	017.01.046	NASTAVAK IZLAZNI KUT 120
010022	017.01.029	NASTAVAK IZLAZNI RAVNI
010067	019.01.101	ČEP ULJNI
010040	017.40.002	KUČIŠTE PUMPE
010011	016.20.008	KOLEKTOR USISNI RAVNI
010001	015.01.004	KOLJENO ULAZNO
010202	015.01.011	CIJEV ULAZNA RAVNA
010006	015.01.018	NASTAVAK RAVNI
010007	015.01.019	NASTAVAK KUTNI
010002	015.01.006	MATICA
010029	019.07.031	VILICA SPOJNA
-	019.31.307	IMBUS VIJAK VILICE

ŠIFRA	KAT. BROJ	NAZIV
010211	017.44.005	KLIP
010043	017.43.003	OSOVINA KLIPA
190403	019.38.004	USKOČNIK
010044	017.43.008	VRATILO EKSCENTRIČNO
190252	019.21.010	LEŽAJ
010226	019.13.004	SEMERING
010035	017.11.003	BRTVA
010041	017.41.002	PRIRUBNICA
-	019.31.301	VIJAK PRIRUBNICE
010212	017.47.001	CILINDAR
010096	019.14.003	MEMBRANA
010020	017.01.013	PODLOŠKA MEMBRANE
010328	019.30.403	VIJAK MEMBRANE
010206	017.03.002	KOMORA PUMPE
-	019.31.305	VIJAK KOMORE PUMPE
010078	019.10.005	GUMICA
010010	016.20.003	VENTIL PROTUPOVRATNI
190051	019.21.008	LEŽAJ
010019	017.01.012	OBRUČ DISTANCE
010018	017.011.011	ODSTOJNIK CILINDRIČNI
190402	017.49.006	OBUJMICA KLIPNJAČE
010229	019.24.002	LEŽAJ IGLIČASTI FKL
010234	017.45.002	KLIPNJAČA FKL



PUMPU BM 65-30 P (ATOMIZER)

BM 65-30 P (atomizer)

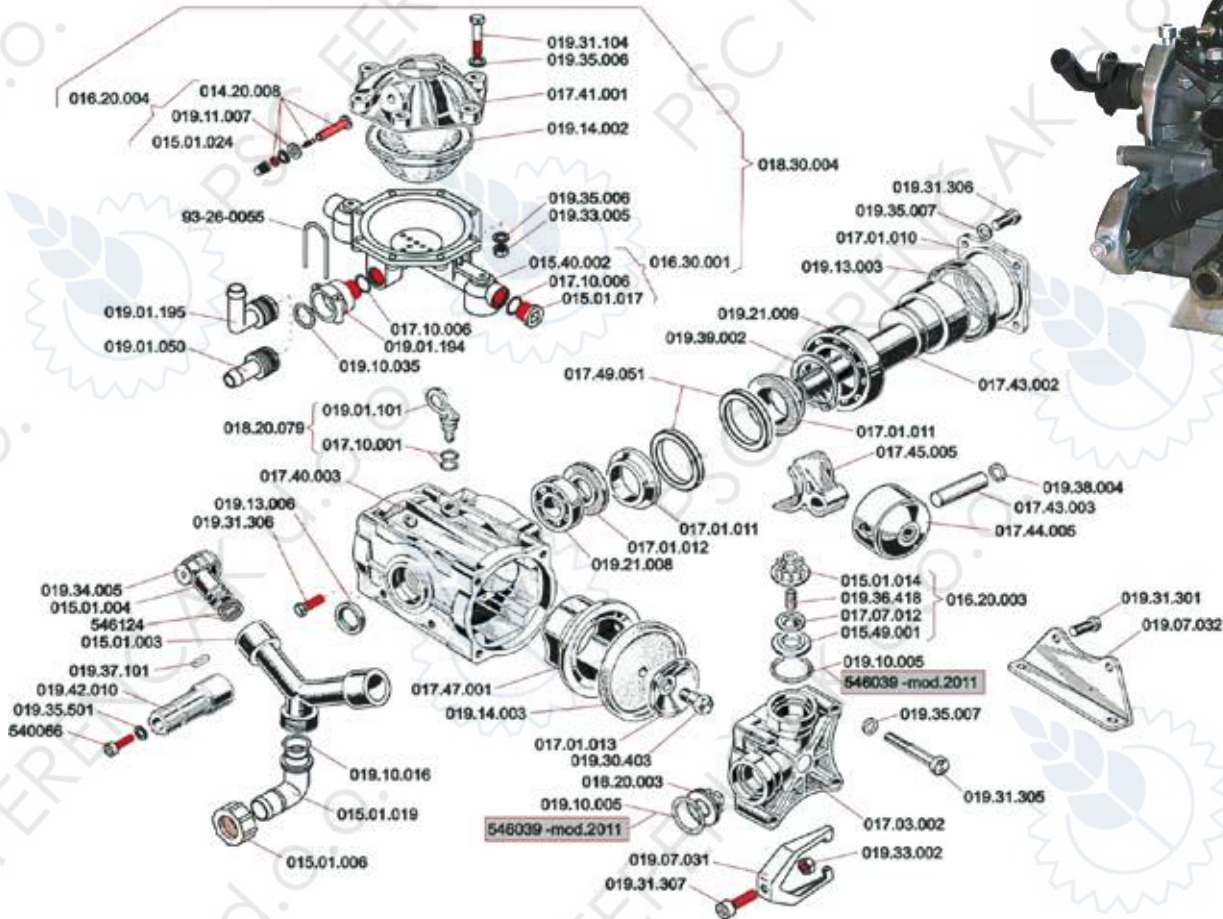

10

ŠIFRA	KATALOŠKI BROJ	NAZIV
010134	020.30.039	PUMPA 65/30 ATOMIZERA
-	017.40.003	KUČIŠTE PUMPE
-	016.20.008	KOLEKTOR USISNI "V"
010201	015.01.003	CIJEV ULAZNA KRIVA
-	019.32.703	MATICA
010209	017.43.002	VRATILO EKSCENTRIČNO
190050	019.21.009	LEŽAJ
010092	019.13.003	SEMERING
-	017.01.010	PRIRUBNICA
010079	019.10.006	GUMICA
050160	019.37.101	KAJLA
010107	019.42.010	PRIKLJUČAK KARDANSKOG VRATILA
-	019.35.502	PODLOŠKA
-	019.31.307	VIJAK



PROTOČNI REGULATOR A3

Protočni regulator A3

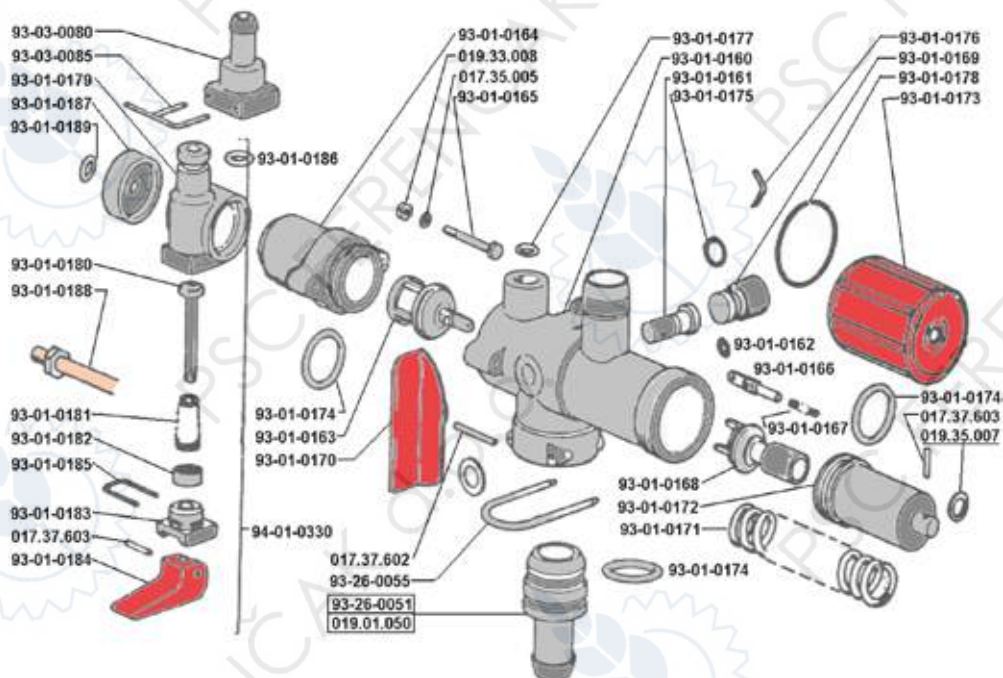

10

ŠIFRA	KAT. BROJ	NAZIV
010143	93-03-0080	USNIK PRIKLJUČNI
010144	93-03-0085	"U" OSIGURAČ
-	93-01-0179	KUČIŠTE VENTILA
010451	93-01-0187	POKLOPAC REGULATORA
-	93-01-0189	GUMICA
-	93-01-0186	GUMICA
-	93-01-0180	VENTIL
-	93-01-0188	PRIČVRSNI VIJAK
-	93-01-0181	KONUSNA OPRUGA
-	93-01-0182	ODSTOJAC SA ŽLIJEBOM
-	93-01-0185	"U" OSIGURAČ
-	93-01-0183	KLIZNA VOĐICA
-	017.37.603	OSOVINA OPRUGE
010027	93-01-0184	RUČKA VENTILA
010149	94-01-0330	RAZVODNI VENTIL
-	93-01-0164	PRIRUBNICA
-	019.33.008	MATICA M5
-	017.35.005	PODLOŠKA
-	93-01-0165	VIJAK
010453	93-01-0174	GUMICA
010452	93-01-0163	OPRUGA

ŠIFRA	KAT. BROJ	NAZIV
-	93-01-0170	RUČICA MJENJAČA
-	017.37.602	OSOVINA OPRUGE
010145	93-26-0055	"U" OSIGURAČ
-	93-26-0051	USNIK
010064	019.01.050	USNIK
-	93-01-0177	GUMICA MANOMETRA
-	93-01-0160	KUČIŠTE
-	93-01-0161	OSOVINA MJENJAČA
-	93-01-0175	GUMICA
-	93-01-0162	ZAPTIVNA GUMICA
-	93-01-0166	GIBLJIVI ZGLOB
-	93-01-0167	OPRUGA
-	93-01-0168	VOĐICA REGULATORA
-	93-01-0172	KUČIŠTE OPRUGE
-	93-01-0171	REGULACIJSKA OPRUGA
-	93-01-0176	FIKSIRNA OPRUGA
-	93-01-0169	NASTAVNI ČEP
010142	93-01-0178	OPRUŽNI PRSTEN
010400	93-01-0173	REGULACIJSKA MATICA
-	019.35.007	PODLOŠKA



REGULATOR PR-3

REGULATOR PR-3

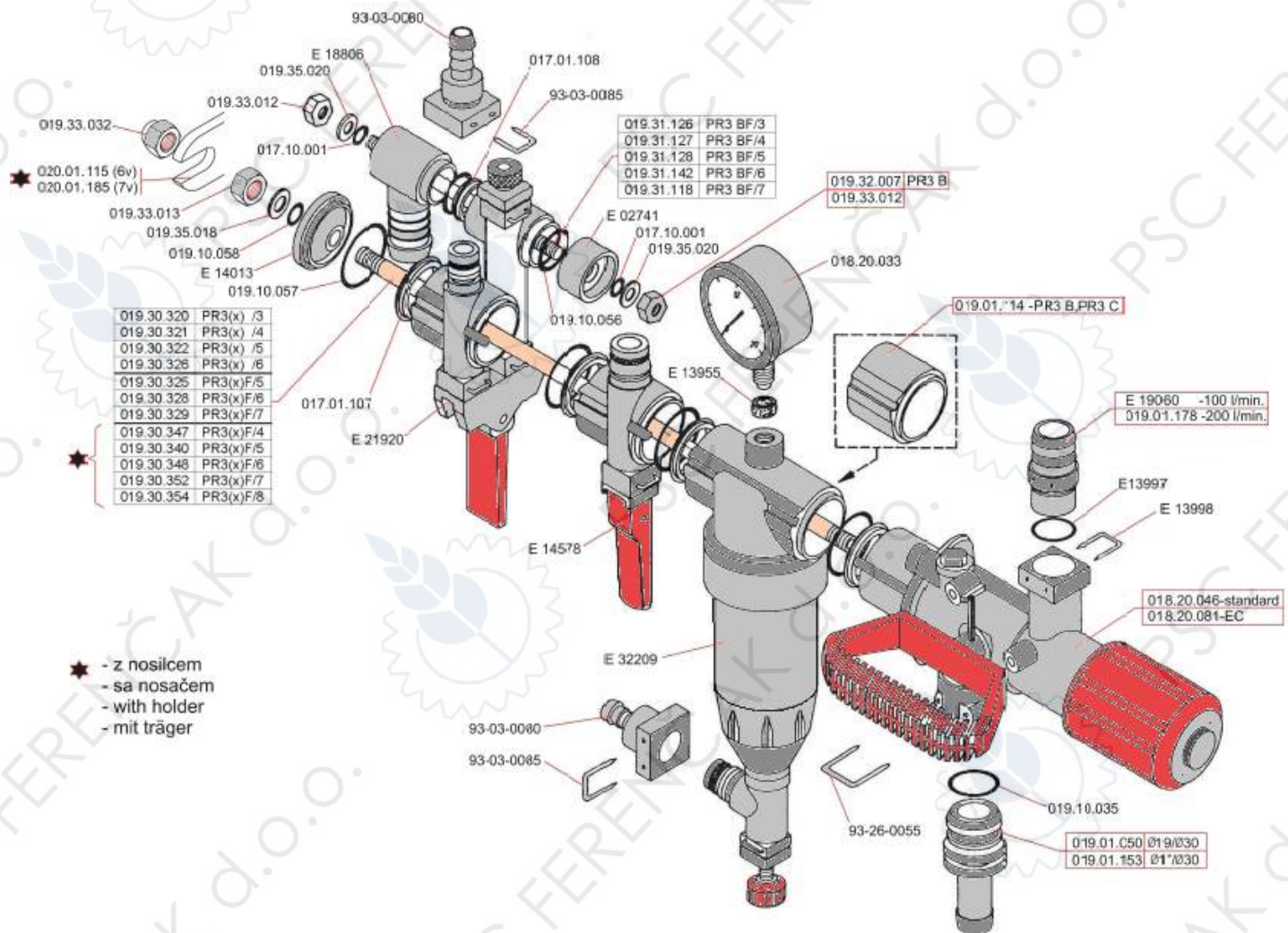

019.30.320	PR3(x) /3
019.30.321	PR3(x) /4
019.30.322	PR3(x) /5
019.30.326	PR3(x) /6
019.30.325	PR3(x)F/5
019.30.328	PR3(x)F/6
019.30.329	PR3(x)F/7
019.30.347	PR3(x)F/4
019.30.340	PR3(x)F/5
019.30.348	PR3(x)F/6
019.30.352	PR3(x)F/7
019.30.354	PR3(x)F/8

019.31.126	PR3 BF/3
019.31.127	PR3 BF/4
019.31.128	PR3 BF/5
019.31.142	PR3 BF/6
019.31.118	PR3 BF/7

019.32.007	PR3 B
019.33.012	

019.01."14	-PR3 B,PR3 C
------------	--------------

E 19060	-100 l/min.
019.01.178	-200 l/min.

E13997	
E 13998	

018.20.046	-standard
018.20.081	-EC

019.01.050	@19/030
019.01.153	@17/030

- ★ - z nosilcem
- sa nosačem
- with holder
- mit träger



ŠIFRA	KAT. BROJ	NAZIV
010143	93-03-0080	USNIK PRIKLJUČKA
195306	E 14013	POKLONAC
190302	017.01.107	DISTANCA VENTILA
010160	E 14578	VENTIL RAZVODNI PR 10
010155	E 13955	GUMICA MANOMETRA
010064	019.01.050	USNIK
010144	93-03-0085	"U" OSIGURAČ
190266	019.10.056	GUMICA
010086	019.10.057	GUMICA
010085	019.10.035	GUMICA
010158	E 32209	POKROV FILTERA
194199	E 31920	VENTIL RAZ. DVOSMJERNI
010139	E 26012	RUČICA REGULATORA
192909	018.20.033	MANOMETAR



CENTRALNI DIO REGULATORA PR-3

DIJELOVI CENTRALNOG DIJELA REGULATORA PR-3

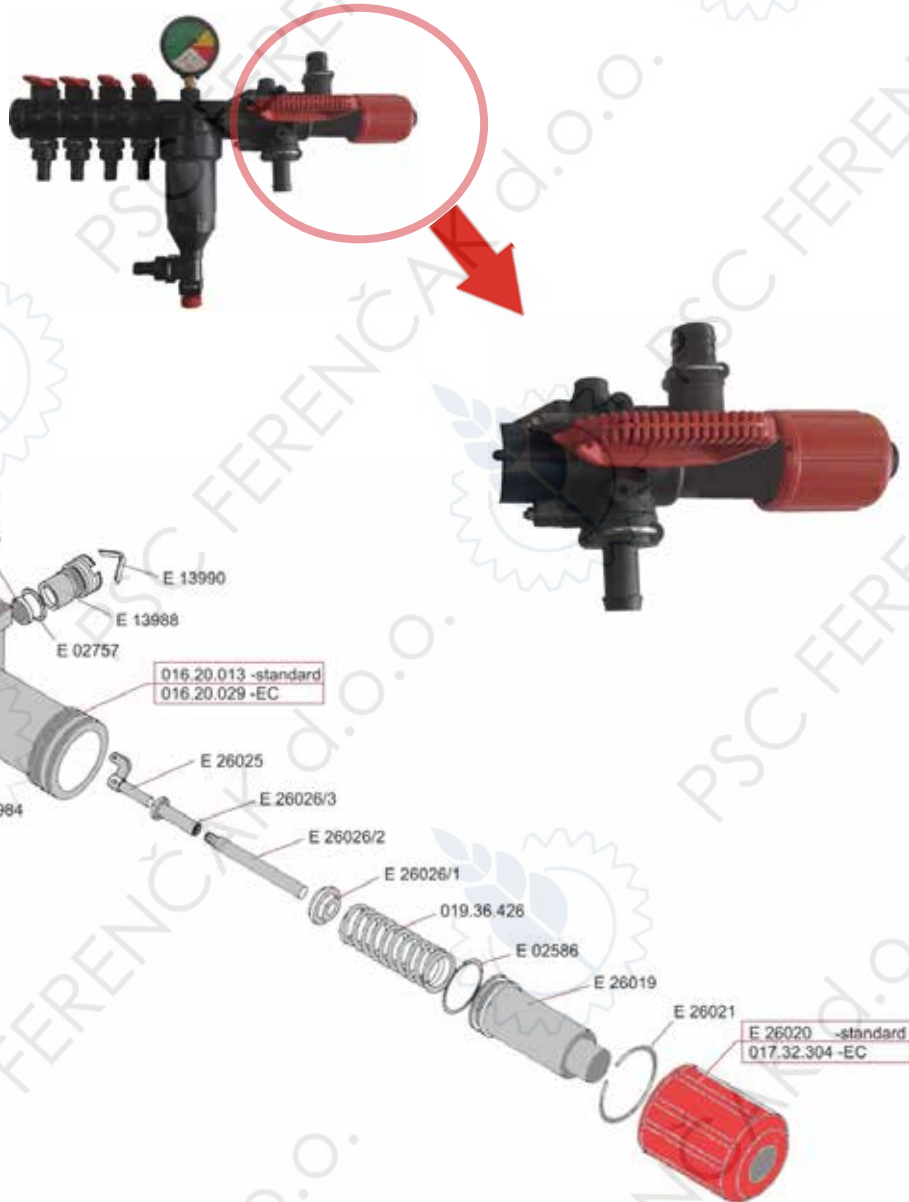

10

ŠIFRA	KAT. BROJ	NAZIV
-	019.33.011	-
-	019.35.017	-
191260	E 13999	PRIRUBNICA REGULATORA
193534	E 26014	GUMICA
193535	E 05244	GUMICA
010161	E 26016	OPRUGA PR 3
-	017.37.616	-
010139	E 26012	RUČICA REGULATORA
-	E 07217	-
-	E 05205	-
-	E 13984	-
010317	E 26017	PLOČICE OPRUGE
120024	E 15738	ČEP R 1/4" PVC
010155	E 13955	GUMICA MANOMETRA

ŠIFRA	KAT. BROJ	NAZIV
-	E 13991	-
192447	E 13990	OPRUGA REG. POLUKRUŽNA
-	E 13998	-
-	E 02757	-
-	016.20.013	-
-	E 26025	-
196944	E 26026/3	KLIP REGULATORA
195392	E 26026/2	OSOVINA REGULATORA
196954	E 26026/1	PRODUŽETAK OSOVINE REG.
195236	019.36.426	OPRUGA TL.
-	E 02586	-
-	E 26019	-
-	E 26021	-
010162	E 26020	MATICA REGULACIJSKA



VENTIL PR 1

VENTIL PR 1

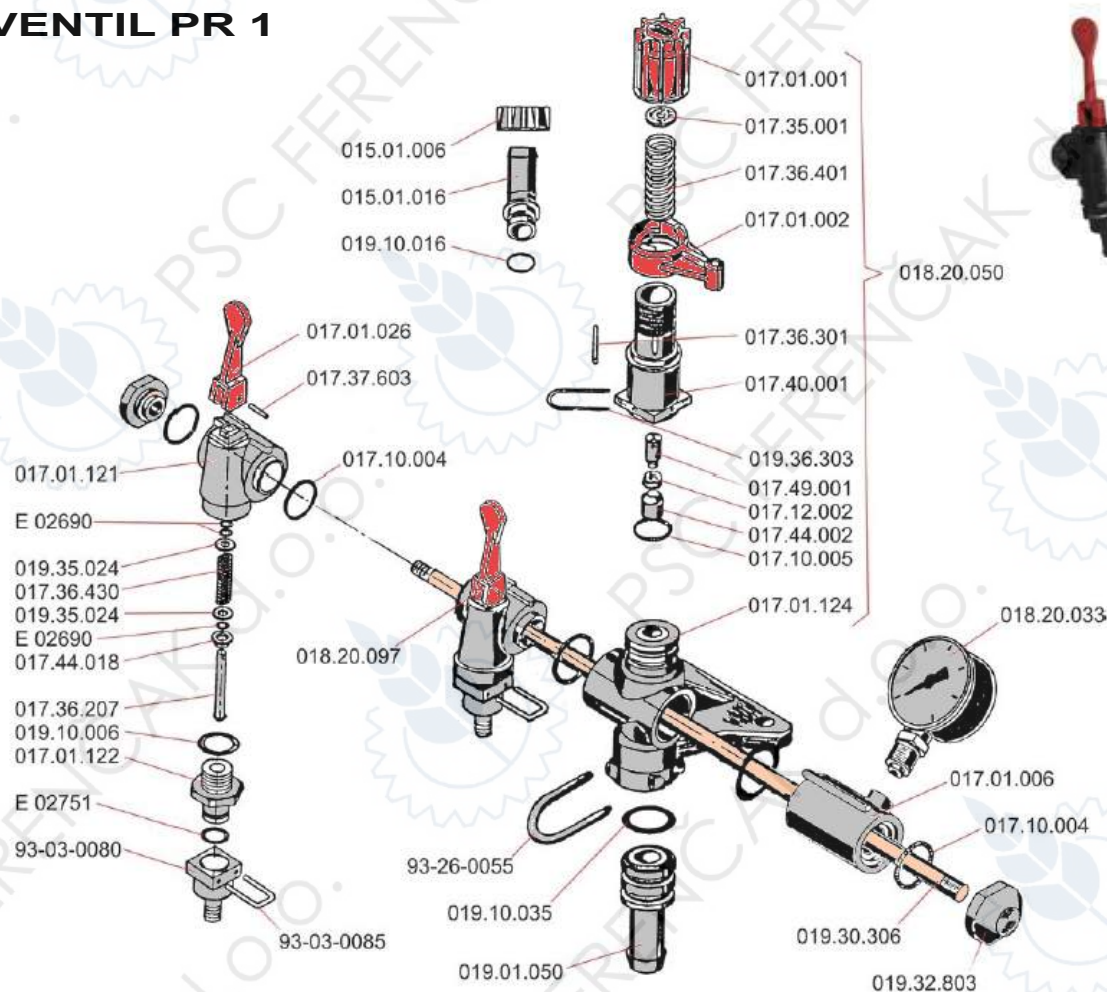

10

ŠIFRA	KAT. BROJ	NAZIV
-	017.01.121	KUČIŠTE RAZ. VENTILA
010350	E 02690	GUMICA
-	019.35.024	PODLOŠKA
-	017.36.430	OPRUGA
-	017.44.018	PODLOŠKA
191215	017.36.207	OSOVINICA RAZ. VENTILA PR1
010079	019.10.006	GUMICA
010243	E 02751	GUMICA
010143	93-03-0080	NASTAVAK CRIJEVA
010144	93-03-0085	"U" OSIGURAČ
010291	017.01.026	RUČICA RAZ. VENTILA PR 1
-	017.37.603	OSOVINA OPRUGE
010032	017.10.004	GUMICA
010055	018.20.097	VENTIL RAZ. PR 1
010145	93-26-0055	"U" OSIGURAČ
010085	019.10.035	GUMICA
010064	019.01.050	NASTAVAK
192909	018.20.033	MANOMETAR
010257	017.10.005	GUMICA

ŠIFRA	KAT. BROJ	NAZIV
010017	017.01.006	NOSAČ MANOMETRA
010032	017.10.004	GUMICA
195108	019.30.306	VIJAK VEZNI
010259	019.32.803	MATICA VEZNA
010002	015.01.006	MATICA
010005	015.01.016	NASTAVAK KUTNI
010082	019.10.016	GUMICA
010052	018.20.050	REGULACIJSKI VENTIL PR 1 kpl
191259	017.01.001	MATICA REGULATORA PR 1
-	017.35.001	PODLOŠKA
010262	017.36.401	OPRUGA REG. VENTILA PR 1
193498	017.01.002	RUČICA REG. VENTILA PR 1
-	017.35.301	PODLOŠKA
010042	017.40.001	KUČIŠTE REG. VENTILA PR 1
010104	019.36.303	"U" OSIGURAČ
010393	017.49.001	KLIPIĆ ZA PR1
010036	017.12.002	MANŽETA
-	017.44.002	KLIP REGULACIJSKI



VENTIL TROPOLNI

VENTIL TROPOLNI

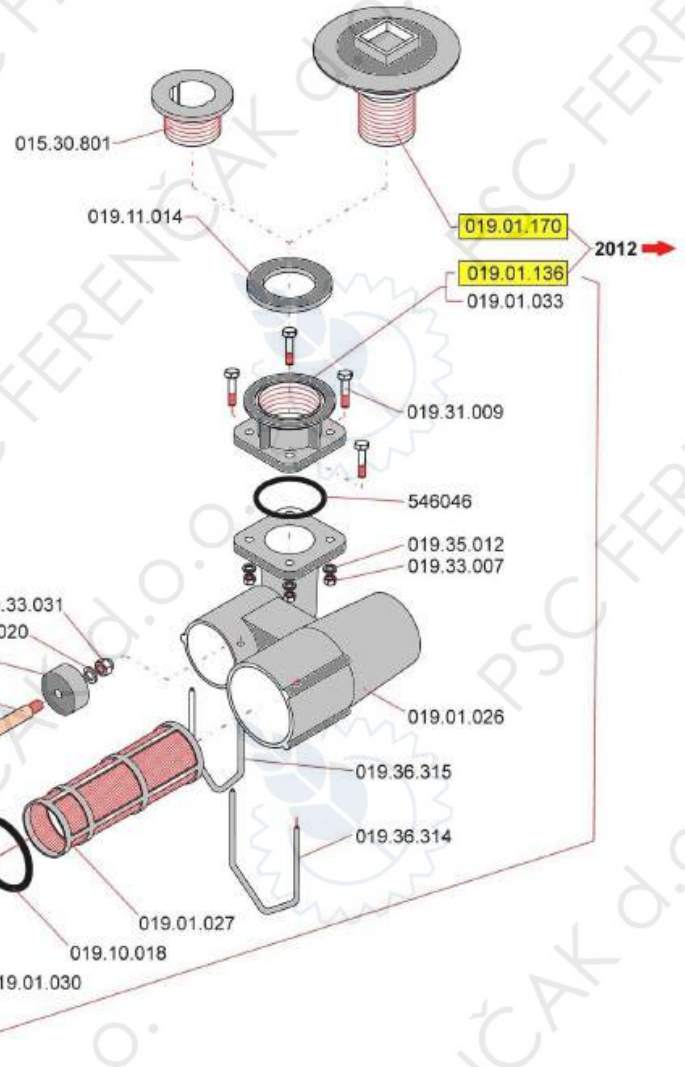

10

ŠIFRA	KAT. BROJ	NAZIV
010138	018.20.077	VENTIL TROPOLNI
-	019.01.032	NASTAVAK USISNI
010408	019.10.021	GUMICA USISNOG NASTAVKA
-	019.36.312	OSOVINA
-	019.01.031	REGULACIJSKI UMETAK
-	019.01.034	GUMB POTEZNI
-	019.36.437	OPRUGA PRITISNA
-	019.36.414	OPRUGAPRITISNA
-	019.34.008	PODMETAČ
-	019.10.058	GUMICA
010078	019.10.005	GUMICA
010313	019.01.030	IZLAZ TROPOLNOG VENTILA
010083	019.10.018	GUMICA

ŠIFRA	KAT. BROJ	NAZIV
-	019.01.027	FILTER
010106	019.36.315	"U" OSIGURAČ
010105	019.36.314	"U" OSIGURAČ
-	018.20.031	REGULACIJSKA OSOVINA
010008	015.30.801	VIJAK FILTERA
010087	019.11.014	GUMICA
-	019.31.009	VIJAK M6x20
010246	019.01.033	PRIKLJUČAK
010084	019.10.019	GUMICA
-	019.35.005	PODLOŠKA
010468	019.33.007	MATICA
-	019.01.026	TIJELO VENTILA



FILTER REGULATORA PR 3

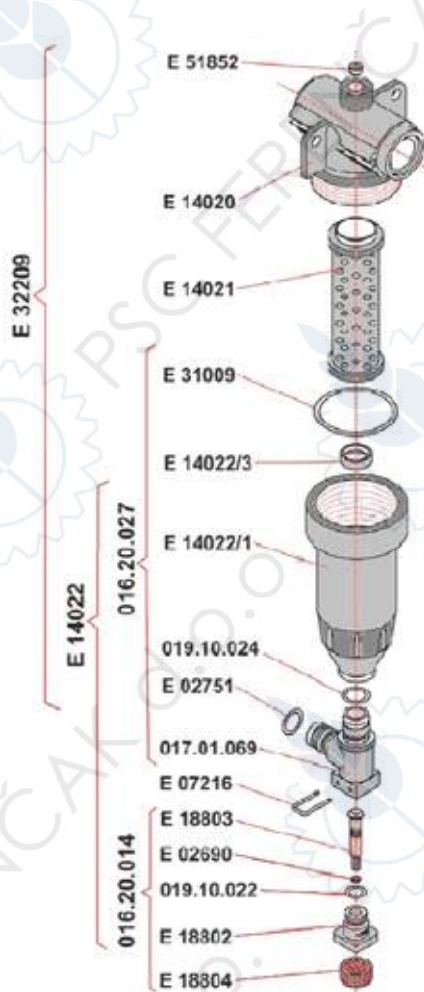

ŠIFRA	KAT. BROJ	NAZIV
010492	E 51852	GUMICA
010223	E 14020	TIJELO FILTERA
010157	E 14021	ULOŽAK FILTERA 45/1
010163	E 31009	GUMICA
-	E 14022/3	-
010158	E 14022/1	POKROV FILTERA
-	019.10.024	-
010243	E 02751	GUMICA
-	017.01.069	-
-	E 07216	-
-	E 18803	-
-	E 02690	-
010409	019.10.022	GUMICA
-	E 18802	-
-	E 18804	-
191247	016.20.027	POKLOPAC FILTERA
202745	016.20.014	VENTIL FILTERA
-	E 14022	-
-	E 32209	-

10

VENTIL REGULATORA PR 3

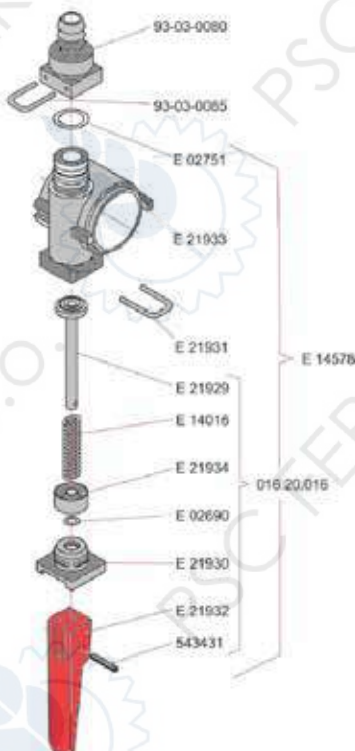

ŠIFRA	KAT. BROJ	NAZIV
010143	93-03-0080	NASTAVAK CRIJEVA
010144	93-03-0085	"U" OSIGURAČ
010243	E 02751	GUMICA
-	E 21933	-
-	E 21931	-
192042	E 21929	OSOVINA RAZV. VENTILA
190056	E 14016	OPRUGA RAZV. VENTILA
-	E 21934	-
010350	E 02690	GUMICA
-	E 21930	-
010027	E 21932	RUČICA RAZV. VENTILA
-	543431	-
010204	016.20.016	KOMPLET REGUL. VENTIL PR 3
010160	E 14578	VENTIL RAZVODNI PR 3

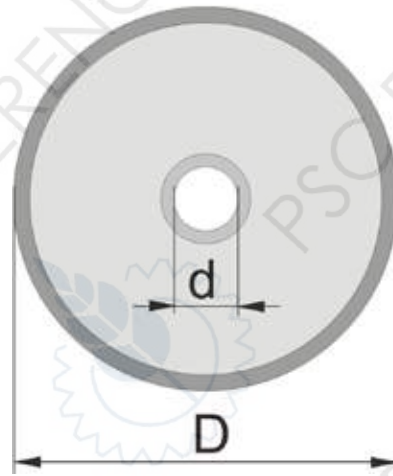
**MEMBRANE ZA PUMPE****Tip 1 - tlačna****Tip 2 - zračna****10**

ŠIFRA	KAT. BROJ	D (mm)	d (mm)	NAZIV	ŠIFRA	KAT. BROJ	D (mm)	d (mm)	NAZIV
010388	-	-	-	Membrana 1800/1	195265	-	-	-	Membrana tlačna Bertolini 105
010426	-	-	-	Membrana 1800/35	192396	547067	113	-	Membrana tlačna BM105
194317	-	-	-	Membrana AR 18/18	010425	-	112	13	Membrana tlačna Comet
202919	-	-	-	Membrana AR 55/19	190226	-	125	13	Membrana tlačna Comet
200103	-	-	-	Membrana AR 80/19	202729	-	-	-	Membrana tlačna D-127 Rau
010094	019.14.004	70	10	Membrana tlačna	192040	-	90	-	Membran tlačna P 52
199801	-	-	-	Membrana kompr. AR 202	192041	-	-	-	Membrana tlačna P 72
010097	019.14.008	100	12	Membrana kompr. fi 100mm	200280	950041312	122	-	Membrana zračna Bertolini
010096	019.14.003	116	12	Membrana kompr. fi 116mm	201277	1800003500	138	-	Membran zračna Comeet
193427	-	-	-	Membrana Morava - čep	202950	-	-	-	Membrana zračna Holder K100
197067	-	108	-	Membrana Morava zračna	195104	-	113	-	Membrana zračna BP
197066	-	107	14	Membrana Morava tlačna	010098	019.14.009	100	-	Membrana zračna
191674	-	-	-	Membrana Morava garnitura	010093	019.14.002	150	-	Membrana zračna
040187	01022609	-	-	Membrana P 102 tlačna	010166	017.130.035	-	-	Membrana zračna
192190	-	-	-	Membrana P 102 zračna	010240	-	-	-	Membrana zračna Comet
195267	01022609	131	-	Membrana P 102 zračna Rau	010239	577058	100	-	Membrana zračna P 52
201433	-	-	-	Membrana pumpe Holder	010165	G0961300	-	-	Membrana zračna PA 908
202985	-	-	-	Membrana Rau-Vicon	010095	019.14.005	73	-	Membrana zračna
195105	-	-	-	Membrana tlačna Comet	199215	J0801900	122	-	Membrana zračna AR
010277	28.0040.31	119	12	Membrana tlačna Bertolini	202730	-	-	-	Membrana zračna Rau





DIZE ZA PRSKALICE

TIP DIZE	KAT. BROJ
Diza TeeJet AI-3070-02VP s maticom	202637
Diza TeeJet AI-3070-03VP s maticom	202638
Diza TeeJet AI-3070-04VP s maticom	202639

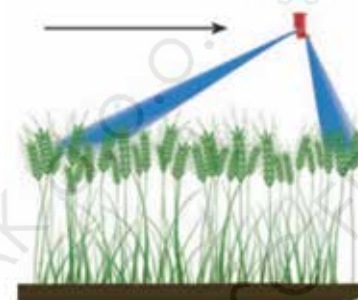

Tip dize	bar	vel. kapljice**	kapacitet po dizi l/min	l/ha Δ 50cm												
				4 km/h	5 km/h	6 km/h	7 km/h	8 km/h	9 km/h	10 km/h	12 km/h	16 km/h	20 km/h	25 km/h	30 km/h	35 km/h
AI3070-015VP (100)	1.5	VC	0.42	126	101	84.0	72.0	63.0	50.4	42.0	31.5	28.0	25.2	20.2	16.80	14.4
	2.0	C	0.48	144	115	96.0	82.3	72.0	57.6	48.0	36.0	32.0	28.8	23.0	19.20	16.5
	3.0	C	0.59	177	142	118	101	88.5	70.8	59.0	44.3	39.3	35.4	28.3	23.6	20.2
	4.0	M	0.68	204	163	136	117	102	81.6	68.0	51.0	45.3	40.8	32.6	27.2	23.3
	5.0	M	0.76	228	182	152	130	114	91.2	76.0	57.0	50.7	45.6	36.5	30.4	26.1
	5.0	M	0.83	249	199	166	142	125	99.6	83.0	62.3	55.3	49.8	39.8	33.2	28.5
AI3070-02VP (100)	1.5	XC	0.56	168	134	112	96.0	84.0	67.2	56.0	42.0	37.3	33.6	26.9	22.4	19.2
	2.0	VC	0.65	195	156	130	111	97.5	78.0	65.0	48.8	43.3	39.0	31.2	26.0	22.3
	3.0	C	0.79	237	190	158	135	119	94.8	79.0	59.3	52.7	47.4	37.9	31.6	27.1
	4.0	C	0.91	273	218	182	156	137	109	91.0	68.3	60.7	54.6	43.7	36.4	31.2
	5.0	M	1.02	306	245	204	175	153	122	102	76.5	68.0	61.2	49.0	40.8	35.0
	5.0	M	1.12	336	269	224	192	168	134	112	84.0	74.7	67.2	53.8	44.8	38.4
AI3070-025VP (100)	1.5	XC	0.70	210	168	140	120	105	84.0	70.0	52.5	46.7	42.0	33.6	28.0	24.0
	2.0	VC	0.81	243	194	162	139	122	97.2	81.0	60.8	54.0	48.6	38.9	32.4	27.8
	3.0	C	0.99	297	238	198	170	149	119	99.0	74.3	66.0	59.4	47.5	39.6	33.9
	4.0	C	1.14	342	274	228	195	171	137	114	85.5	76.0	68.4	54.7	45.6	39.1
	5.0	C	1.28	384	307	256	219	192	154	128	96.0	85.3	76.8	61.4	51.2	43.9
	5.0	M	1.40	420	336	280	240	210	168	140	105	93.3	84.0	67.2	56.0	48.0
AI3070-03VP (50)	1.5	XC	0.83	249	199	166	142	125	99.6	83.0	62.3	55.3	49.8	39.8	33.2	28.5
	2.0	XC	0.96	288	230	192	165	144	115	96.0	72.0	64.0	57.6	46.1	38.4	32.9
	3.0	C	1.18	354	283	236	202	177	142	118	88.5	78.7	70.8	56.6	47.2	40.5
	4.0	C	1.36	408	326	272	233	204	163	136	102	90.7	81.6	65.3	54.4	46.6
	5.0	C	1.52	456	365	304	261	228	182	152	114	101	91.2	73.0	60.8	52.1
	5.0	C	1.67	501	401	334	286	251	200	167	125	111	100	80.2	66.8	57.3
AI3070-04VP (50)	1.5	UC	1.12	336	269	224	192	168	134	112	84.0	74.7	67.2	53.8	44.8	38.4
	2.0	XC	1.29	387	310	258	221	194	155	129	96.8	86.0	77.4	61.9	51.6	44.2
	3.0	VC	1.58	474	379	316	271	237	190	158	119	105	94.8	75.8	63.2	54.2
	4.0	VC	1.82	546	437	364	312	273	218	182	137	121	109	87.4	72.8	62.4
	5.0	C	2.04	612	490	408	350	306	245	204	153	136	122	97.9	81.6	69.9
	6.0	C	2.23	669	535	446	382	335	268	223	167	149	134	107	89.2	76.5
AI3070-05VP (50)	1.5	UC	1.39	417	334	278	238	209	167	139	104	92.7	83.4	66.7	55.6	47.7
	2.0	XC	1.61	483	386	322	276	242	193	161	121	107	96.6	77.3	64.4	55.2
	3.0	VC	1.97	591	473	394	338	296	236	197	148	131	118	94.6	78.8	67.5
	4.0	VC	2.27	681	545	454	389	341	272	227	170	151	136	109	90.8	77.8
	5.0	C	2.54	762	610	508	435	381	305	254	191	169	152	122	102	87.1
	6.0	C	2.79	837	670	558	478	419	335	279	209	186	167	134	112	95.7

**Prosječna veličina promjera kapljice iskazana je u mikronima (10^{-3} mm), a pripadajuće slovne oznake dane su u tablici.

Kontakti preparati	Sistemici	Upravljanje zanošenjem
IZVRSNO	JAKO DOBRO	IZVRSNO

Ova vrsta dize omogućuje prskanje kod umjerenog vjetro.



Optimalni odnos razmaka diza i visina prilikom prskanja

40 cm	22 cm
50 cm	30 cm
75 cm	45 cm

Oznaka	Boja	Srednja veličina kapljice (mikroni)
XF		~50
VF		<136
F		136-177
M		177-218
C		218-349
VC		349-428
XC		428-622
UC		>622

10



DIZE ZA PRSKALICE

TIP DIZE	KAT. BROJ
Diza TeeJet AIXR-11002VP	202634
Diza TeeJet AIXR-11003VP	202559
Diza TeeJet AIXR-11004VP	202560
Diza TeeJet AIXR-11005VP	205614



10

Tip Dize	bar	vel. kapljice**	kapacitet po dizi Visina	l/ha Δ 50cm													
				4 km/h	5 km/h	6 km/h	7 km/h	8 km/h	9 km/h	10 km/h	12 km/h	16 km/h	20 km/h	25 km/h	30 km/h	35 km/h	
AIXR110015 (100)	1.0	XC	0.34	102	81.6	68.0	58.3	51.0	40.8	34.0	25.5	22.7	20.4	16.3	13.6	11.7	
	2.0	VC	0.48	144	115	96.0	82.3	72.0	57.6	48.0	36.0	32.0	28.8	23.0	19.2	16.5	
	3.0	C	0.59	177	142	118	101	88.5	70.8	59.0	44.3	39.3	35.4	28.3	23.6	20.2	
	4.0	C	0.68	204	163	136	117	102	81.6	68.0	51.0	45.3	40.8	32.6	27.2	23.3	
	5.0	M	0.76	228	182	152	130	114	91.2	76.0	57.0	50.7	45.6	36.5	30.4	26.1	
6.0	M	0.83	249	199	166	142	125	99.6	83.0	62.3	55.3	49.8	39.8	33.2	28.5		
AIXR11002 (50)	1.0	XC	0.46	138	110	92.0	78.9	69.0	55.2	46.0	34.5	30.7	27.6	22.1	18.4	15.8	
	2.0	VC	0.65	195	156	130	111	97.5	78.0	65.0	48.8	43.3	39.0	31.2	26.0	22.3	
	3.0	C	0.79	237	190	158	135	119	94.8	79.0	59.3	52.7	47.4	37.9	31.6	27.1	
	4.0	C	0.91	273	218	182	156	137	109	91.0	68.3	60.7	54.6	43.7	36.4	31.2	
	5.0	C	1.02	306	245	204	175	153	122	102	76.5	68.0	61.2	49.0	40.8	35.0	
6.0	M	1.12	336	269	224	192	168	134	112	84.0	74.7	67.2	53.8	44.8	38.4		
AIXR110025 (50)	1.0	XC	0.57	171	137	114	97.7	85.5	68.4	57.0	42.8	38.0	34.2	27.4	22.8	19.5	
	2.0	XC	0.81	243	194	162	139	122	97.2	81.0	60.8	54.0	48.6	38.9	32.4	27.8	
	3.0	VC	0.99	297	238	198	170	149	119	99.0	74.3	66.0	59.4	47.5	39.6	33.9	
	4.0	C	1.14	342	274	228	195	171	137	114	85.5	76.0	68.4	54.7	45.6	39.1	
	5.0	C	1.28	384	307	256	219	192	154	128	96.0	85.3	76.8	61.4	51.2	43.9	
6.0	C	1.40	420	336	280	240	210	168	140	105	93.3	84.0	67.2	56.0	48.0		
AIXR11003 (50)	1.0	XC	0.68	204	163	136	117	102	81.6	68.0	51.0	45.3	40.8	32.6	27.2	23.3	
	2.0	XC	0.96	288	230	192	165	144	115	96.0	72.0	64.0	57.6	46.1	38.4	32.9	
	3.0	VC	1.18	354	283	236	202	177	142	118	88.5	78.7	70.8	56.6	47.2	40.5	
	4.0	C	1.36	408	326	272	233	204	163	136	102	90.7	81.6	65.3	54.4	46.6	
	5.0	C	1.52	456	365	304	261	228	182	152	114	101	91.2	73.0	60.8	52.1	
6.0	C	1.67	501	401	334	286	251	200	167	125	111	100	80.2	66.8	57.3		
AIXR11004 (50)	1.0	UC	0.91	273	218	182	156	137	109	91.0	68.3	60.7	54.6	43.7	36.4	31.2	
	2.0	XC	1.29	387	310	258	221	194	155	129	96.8	86.0	77.4	61.9	51.6	44.2	
	3.0	VC	1.58	474	379	316	271	237	190	158	119	105	94.8	75.8	63.2	54.2	
	4.0	VC	1.82	546	437	364	312	273	218	182	137	121	109	87.4	72.8	62.4	
	5.0	C	2.04	612	490	408	350	306	245	204	153	136	122	97.9	81.6	69.9	
6.0	C	2.23	669	535	446	382	335	268	223	167	149	134	107	89.2	76.5		
AIXR11005 (50)	1.0	UC	1.14	342	274	228	195	171	137	114	85.5	76.0	68.4	54.7	45.6	39.1	
	2.0	XC	1.61	483	386	322	276	242	193	161	121	107	96.6	77.3	64.4	55.2	
	3.0	XC	1.97	591	473	394	338	296	236	197	148	131	118	94.6	78.8	67.5	
	4.0	VC	2.27	681	545	454	389	341	272	227	170	151	136	109	90.8	77.8	
	5.0	C	2.54	762	610	508	435	381	305	254	191	169	152	122	102	87.1	
6.0	C	2.79	837	670	558	478	419	335	279	209	186	167	134	112	95.7		
AIXR11006 (50)	1.0	UC	1.37	411	329	274	235	206	164	137	103	91.3	82.2	65.8	54.8	47.0	
	2.0	XC	1.94	582	466	388	333	291	233	194	146	129	116	93.1	77.6	66.5	
	3.0	XC	2.37	711	569	474	406	356	284	237	178	158	142	114	94.8	81.3	
	4.0	VC	2.74	822	658	548	470	411	329	274	206	183	164	132	110	93.9	
	5.0	C	3.06	918	734	612	525	459	367	306	230	204	184	147	122	105	
6.0	C	3.35	1005	804	670	574	503	402	335	251	223	201	161	134	115		

Kontakti preparati	Sistemi	Upravljanje zanošenjem
DOBRO	IZVRSNO	IZVRSNO



Optimalni odnos razmaka diza i visina prilikom prskanja

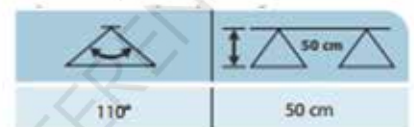



DIZE ZA PRSKALICE

TIP DIZE	KAT. BROJ
Diza StreamJet SJ7-02VP	202568
Diza StreamJet SJ7-03VP	202559
Diza StreamJet SJ7-04VP	202569



10

Diza	bar	kapacitet po dizi l/min	l/ha 50cm									
			4 km/h	6 km/h	8 km/h	10 km/h	12 km/h	16 km/h	20 km/h	25 km/h	30 km/h	35 km/h
SJ7-01-VP (100)	1.5	0.39	117	78.0	58.5	46.8	39.0	29.3	23.4	18.7	15.6	13.4
	2.0	0.46	138	92.0	69.0	55.2	46.0	34.5	27.6	22.1	18.4	15.8
	2.5	0.52	156	104	78.0	62.4	52.0	39.0	31.2	25.0	20.8	17.8
	3.0	0.57	171	114	85.5	68.4	57.0	42.8	34.2	27.4	22.8	19.5
SJ7-02-VP (50)	1.5	0.55	165	110	82.5	66.0	55.0	41.3	33.0	26.4	22.0	18.9
	2.0	0.64	192	128	96.0	76.8	64.0	48.0	38.4	30.7	25.6	21.9
	2.5	0.72	216	144	108	86.4	72.0	54.0	43.2	34.6	28.8	24.7
	3.0	0.80	240	160	120	96.0	80.0	60.0	48.0	38.4	32.0	27.4
SJ7-03-VP (50)	1.5	0.87	261	174	131	104	87.0	65.3	52.2	41.8	34.8	29.8
	2.0	1.00	300	200	150	120	100	75.0	60.0	48.0	40.0	34.3
	2.5	1.10	330	220	165	132	110	82.5	66.0	52.8	44.0	37.7
	3.0	1.18	354	236	177	142	118	88.5	70.8	56.6	47.2	40.5
SJ7-04-VP (50)	1.5	1.17	351	234	176	140	117	87.8	70.2	56.2	46.8	40.1
	2.0	1.33	399	266	200	160	133	99.8	79.8	63.8	53.2	45.6
	2.5	1.45	435	290	218	174	145	109	87.0	69.6	58.0	49.7
	3.0	1.55	465	310	233	186	155	116	93.0	74.4	62.0	53.1
SJ7-05-VP (50)	1.5	1.49	447	298	224	179	149	112	89.4	71.5	59.6	51.1
	2.0	1.68	504	336	252	202	168	126	101	80.6	67.2	57.6
	2.5	1.83	549	366	275	220	183	137	110	87.8	73.2	62.7
	3.0	1.95	585	390	293	234	195	146	117	93.6	78.0	66.9
SJ7-06-VP (50)	1.5	2.16	648	432	324	259	216	162	130	104	86.4	74.1
	2.0	2.41	723	480	360	288	237	186	148	116	96.0	81.6
	2.5	2.66	798	532	399	319	266	200	160	128	106	91.2
	3.0	2.94	882	588	441	353	294	221	176	141	118	101
SJ7-08-VP	1.5	3.15	945	630	473	378	315	236	189	151	126	108
	2.0	3.46	1038	692	519	415	346	260	208	166	138	119
	2.5	3.67	1101	734	551	440	367	275	220	176	147	126
	3.0	3.94	1182	788	591	473	394	296	236	189	158	135
SJ7-10-VP	1.5	4.33	1299	866	650	520	433	325	260	208	173	148
	2.0	4.09	1227	818	614	491	409	307	245	196	164	140
	2.5	4.82	1446	964	723	578	482	362	289	231	193	165
	3.0	5.40	1620	1080	810	648	540	405	324	259	216	185
SJ7-15-VP	1.5	5.87	1761	1174	881	704	587	440	352	282	235	201
	2.0	6.58	1974	1316	987	790	658	494	395	316	263	226

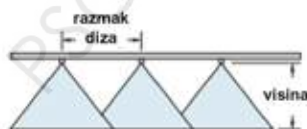

Optimalni odnos razmaka diza i visina prilikom prskanja

razmak diza	visina
50 cm	50 cm
75 cm	75 cm
100 cm	100 cm



DIZE ZA PRSKALICE

TIP DIZE	KAT. BROJ
Diza TeeJet TP-11002VP	202635
Diza TeeJet TP-11003VP	202558
Diza TeeJet TP-11004VP	202636



Tip Dize	bar	vel. kapljice mm	kapacitet po dizi l/min	l/ha													
				4 km/h	5 km/h	6 km/h	7 km/h	8 km/h	9 km/h	10 km/h	12 km/h	16 km/h	20 km/h	25 km/h	30 km/h	35 km/h	
TP650050†	2.0		0.16	48.0	38.4	32.0	27.4	24.0	19.2	16.0	12.0	10.7	9.6	7.7	6.4	5.5	
TP800050†	2.5		0.18	54.0	43.2	36.0	30.9	27.0	21.6	18.0	13.5	12.0	10.8	8.6	7.2	6.2	
TP1100050†	3.0		0.20	60.0	48.0	40.0	34.3	30.0	24.0	20.0	15.0	13.3	12.0	9.6	8.0	6.9	
(100)	3.5		0.22	66.0	52.8	44.0	37.7	33.0	26.4	22.0	16.5	14.7	13.2	10.6	8.8	7.5	
	4.0		0.23	69.0	55.2	46.0	39.4	34.5	27.6	23.0	17.3	15.3	13.8	11.0	9.2	7.9	
TP650067†	2.0		0.21	63.0	50.4	42.0	36.0	31.5	25.2	21.0	15.8	14.0	12.6	10.1	8.4	7.2	
TP800067†	2.5		0.24	72.0	57.6	48.0	41.1	36.0	28.8	24.0	18.0	16.0	14.4	11.5	9.6	8.2	
TP1100067†	3.0		0.26	78.0	62.4	52.0	44.6	39.0	31.2	26.0	19.5	17.3	15.6	12.5	10.4	8.9	
(100)	3.5		0.28	84.0	67.2	56.0	48.0	42.0	33.6	28.0	21.0	18.7	16.8	13.4	11.2	9.6	
	4.0		0.30	90.0	72.0	60.0	51.4	45.0	36.0	30.0	22.5	20.0	18.0	14.4	12.0	10.3	
TP65011†	2.0		0.32	96.0	76.8	64.0	54.9	48.0	38.4	32.0	24.0	21.3	19.2	15.4	12.8	11.0	
TP8001†	2.5		0.36	108	86.4	72.0	61.7	54.0	43.2	36.0	27.0	24.0	21.6	17.3	14.4	12.3	
TP11001†	3.0		0.39	117	93.6	78.0	66.9	58.5	46.8	39.0	29.3	26.0	23.4	18.7	15.6	13.4	
(100)	3.5		0.42	126	101	84.0	72.0	63.0	50.4	42.0	31.5	28.0	25.2	20.2	16.8	14.4	
	4.0		0.45	135	108	90.0	77.1	67.5	54.0	45.0	33.8	30.0	27.0	21.6	18.0	15.4	
TP65015†	2.0		0.48	144	115	96.0	82.3	72.0	57.6	48.0	36.0	32.0	28.8	23.0	19.2	16.5	
TP80015†	2.5		0.54	162	130	108	92.6	81.0	64.8	54.0	40.5	36.0	32.4	25.9	21.6	18.5	
TP110015†	3.0		0.59	177	142	118	101	88.5	70.8	59.0	44.3	39.3	35.4	28.3	23.6	20.2	
(100)	3.5		0.64	192	154	128	110	96.0	76.8	64.0	48.0	42.7	38.4	30.7	25.6	21.9	
	4.0		0.68	204	163	136	117	102	81.6	68.0	51.0	45.3	40.8	32.6	27.2	23.3	
TP6502†	2.0		0.65	195	156	130	111	97.5	78.0	65.0	48.8	43.3	39.0	31.2	26.0	22.3	
TP8002†	2.5		0.72	216	173	144	123	108	86.4	72.0	54.0	48.0	43.2	34.6	28.8	24.7	
TP11002†	3.0		0.79	237	190	158	135	119	94.8	79.0	59.3	52.7	47.4	37.9	31.6	27.1	
(50)	3.5		0.85	255	204	170	146	128	102	85.0	63.8	56.7	51.0	40.8	34.0	29.1	
	4.0		0.91	273	218	182	156	137	109	91.0	68.3	60.7	54.6	43.7	36.4	31.2	
TP6503†	2.0		0.96	288	230	192	165	144	115	96.0	72.0	64.0	57.6	46.1	38.4	32.9	
TP8003†	2.5		1.08	324	259	216	185	162	130	108	81.0	72.0	64.8	51.8	43.2	37.0	
TP11003†	3.0		1.18	354	283	236	202	177	142	118	88.5	78.7	70.8	56.6	47.2	40.5	
(50)	3.5		1.27	381	305	254	218	191	152	127	95.3	84.7	76.2	61.0	50.8	43.5	
	4.0		1.36	408	326	272	233	204	163	136	102	90.7	81.6	65.3	54.4	46.6	
TP6504†	2.0	M	1.29	387	310	258	221	194	155	129	96.8	86.0	77.4	61.9	51.6	44.2	
TP8004†	2.5	M	1.44	432	346	288	247	216	173	144	108	96.0	86.4	69.1	57.6	49.4	
TP11004†	3.0	M	1.58	474	379	316	271	237	190	158	119	105	94.8	75.8	63.2	54.2	
(50)	3.5	F	1.71	513	410	342	293	257	205	171	128	114	103	82.1	68.4	58.6	
	4.0	F	1.82	546	437	364	312	273	218	182	137	121	109	87.4	72.8	62.4	
TP6505†	2.0	M	1.61	483	386	322	276	242	193	161	121	107	96.6	77.3	64.4	55.2	
TP8005†	2.5	M	1.80	540	432	360	309	270	216	180	135	120	108	86.4	72.0	61.7	
TP11005†	3.0	M	1.97	591	473	394	338	296	236	197	148	131	118	94.6	78.8	67.5	
(50)	3.5	M	2.13	639	511	426	365	320	256	213	160	142	128	102	85.2	73.0	
	4.0	F	2.27	681	545	454	389	341	272	227	170	151	136	109	90.8	77.8	
TP6506†	2.0	M	1.94	582	466	388	333	291	233	194	146	129	116	93.1	77.6	66.5	
TP8006†	2.5	M	2.16	648	518	432	370	324	259	216	162	144	130	104	86.4	74.1	
TP11006†	3.0	M	2.37	711	569	474	406	356	284	237	178	158	142	114	94.8	81.3	
(50)	3.5	M	2.56	768	614	512	439	384	307	256	192	171	154	123	102	87.8	
	4.0	M	2.74	822	658	548	470	411	329	274	206	183	164	132	110	93.9	
TP6508†	2.0	C	2.58	774	619	516	442	387	310	258	194	172	155	124	103	88.5	
TP8008†	2.5	M	2.88	864	691	576	494	432	346	288	216	192	173	138	115	98.7	
TP11008†	3.0	M	3.16	948	758	632	542	474	379	316	237	211	190	152	126	108	
(50)	3.5	M	3.41	1023	818	682	585	512	409	341	256	227	205	164	136	117	
	4.0	M	3.65	1095	876	730	626	548	438	365	274	243	219	175	146	125	
TP6510†	2.0	C	3.23	969	775	646	554	485	388	323	242	215	194	155	129	111	
TP8010†	2.5	C	3.61	1083	866	722	619	542	433	361	271	241	217	173	144	124	
TP11010†	3.0	C	3.95	1185	948	790	677	593	474	395	296	263	237	190	158	135	
(50)	3.5	M	4.27	1281	1025	854	732	641	512	427	320	285	256	205	171	146	
	4.0	M	4.56	1368	1094	912	782	684	547	456	342	304	274	219	182	156	
TP6515†	2.0	C	4.83	1449	1159	966	828	725	580	483	362	322	290	232	193	166	
TP8015†	2.5	C	5.40	1620	1296	1080	926	810	648	540	405	360	324	259	216	185	
TP11015†	3.0	C	5.92	1776	1421	1184	1015	888	710	592	444	395	355	284	237	203	
(50)	3.5	C	6.39	1917	1534	1278	1095	959	767	639	479	426	383	307	256	219	
	4.0	C	6.84	2052	1642	1368	1173	1026	821	684	513	456	410	328	274	235	
TP6520†	2.0		6.44	1932	1546	1288	1104	966	773	644	483	429	386	309	258	221	
TP8020†	2.5		7.20	2160	1728	1440	1234	1080	864	720	540	480	432	346	288	247	
TP11020†	3.0		7.89	2367	1894	1578	1353	1184	947	789	592	526	473	379	316	271	
(50)	3.5		8.52	2556	2045	1704	1461	1278	1022	852	639	568	511	409	341	292	
	4.0		9.11	2733	2186	1822	1562	1367	1093	911	683	607	547	437	364	312	



Optimalni odnos razmaka dize i visina prilikom prskanja

razmak	visina
65°	90 cm
80°	75 cm
110°	50 cm

Kontakti preparati	Sistemici	Upravljanje zanošenjem
DOBRO	IZVRNO	IZVRNO



DIZE ZA PRSKALICE

TIP DIZE	KAT. BROJ
Diza Turbo TeeJet TTI-11002VP	202564
Diza Turbo TeeJet TTI-11002VP	202565
Diza Turbo TeeJet TTI-11004VP	202566



10

Diza	bar	vel. kopilice**	kapacitet po dizi l/min	l/ha Δ 50cm												
				4 km/h	5 km/h	6 km/h	7 km/h	8 km/h	9 km/h	10 km/h	12 km/h	16 km/h	20 km/h	25 km/h	30 km/h	35 km/h
TTI110015 (100)	1.0	UC	0.34	102	81.6	68.0	58.3	51.0	40.8	34.0	25.5	22.7	20.4	16.3	13.6	11.7
	2.0	UC	0.48	144	115	96.0	82.3	72.0	57.6	48.0	36.0	32.0	28.8	23.0	19.2	16.5
	3.0	UC	0.59	177	142	118	101	88.5	70.8	59.0	44.3	39.3	35.4	28.3	23.6	20.2
	4.0	XC	0.68	204	163	136	117	102	81.6	68.0	51.0	45.3	40.8	32.6	27.2	23.3
	5.0	XC	0.76	228	182	152	130	114	91.2	76.0	57.0	50.7	45.6	36.5	30.4	26.1
	6.0	XC	0.83	249	199	166	142	125	99.6	83.0	62.3	55.3	49.8	39.8	33.2	28.5
	7.0	XC	0.90	270	216	180	154	135	108	90.0	67.5	60.0	54.0	43.2	36.0	30.9
TTI11002 (50)	1.0	UC	0.46	138	110	92.0	78.9	69.0	55.2	46.0	34.5	30.7	27.6	22.1	18.4	15.8
	2.0	UC	0.65	195	156	130	111	97.5	78.0	65.0	48.8	43.3	39.0	31.2	26.0	22.3
	3.0	UC	0.79	237	190	158	135	119	94.8	79.0	59.3	52.7	47.4	37.9	31.6	27.1
	4.0	UC	0.91	273	218	182	156	137	109	91.0	68.3	60.7	54.6	43.7	36.4	31.2
	5.0	XC	1.02	306	245	204	175	153	122	102	76.5	68.0	61.2	49.0	40.8	35.0
	6.0	XC	1.12	336	269	224	192	168	134	112	84.0	74.7	67.2	53.8	44.8	38.4
	7.0	XC	1.21	363	290	242	207	182	145	121	90.8	80.7	72.6	58.1	48.4	41.5
TTI110025 (50)	1.0	UC	0.57	171	137	114	97.7	85.5	68.4	57.0	42.8	38.0	34.2	27.4	22.8	19.5
	2.0	UC	0.81	243	194	162	139	122	97.2	81.0	60.8	54.0	48.6	38.9	32.4	27.8
	3.0	UC	0.99	297	238	198	170	149	119	99.0	74.3	66.0	59.4	47.5	39.6	33.9
	4.0	UC	1.14	342	274	228	195	171	137	114	85.5	76.0	68.4	54.7	45.6	39.1
	5.0	XC	1.28	384	307	256	219	192	154	128	96.0	85.3	76.8	61.4	51.2	43.9
	6.0	XC	1.40	420	336	280	240	210	168	140	105	93.3	84.0	67.2	56.0	48.0
	7.0	XC	1.51	453	362	302	259	227	181	151	113	101	90.6	72.5	60.4	51.8
TTI11003 (50)	1.0	UC	0.68	204	163	136	117	102	81.6	68.0	51.0	45.3	40.8	32.6	27.2	23.3
	2.0	UC	0.96	288	230	192	165	144	115	96.0	72.0	64.0	57.6	46.1	38.4	32.9
	3.0	UC	1.18	354	283	236	202	177	142	118	88.5	78.7	70.8	56.6	47.2	40.5
	4.0	UC	1.36	408	326	272	233	204	163	136	102	90.7	81.6	65.3	54.4	46.6
	5.0	XC	1.52	456	365	304	261	228	182	152	114	101	91.2	73.0	60.8	52.1
	6.0	XC	1.67	501	401	334	286	251	200	167	125	111	100	80.2	66.8	57.3
	7.0	XC	1.80	540	432	360	309	270	216	180	135	120	108	86.4	72.0	61.7
TTI11004 (50)	1.0	UC	0.91	273	218	182	156	137	109	91.0	68.3	60.7	54.6	43.7	36.4	31.2
	2.0	UC	1.29	387	310	258	221	194	155	129	96.8	86.0	77.4	61.9	51.6	44.2
	3.0	UC	1.58	474	379	316	271	237	190	158	119	105	94.8	75.8	63.2	54.2
	4.0	UC	1.82	546	437	364	312	273	218	182	137	121	109	87.4	72.8	62.4
	5.0	XC	2.04	612	490	408	350	306	245	204	153	136	122	97.9	81.6	69.9
	6.0	XC	2.23	669	535	446	382	335	268	223	167	149	134	107	89.2	76.5
	7.0	XC	2.41	723	578	482	413	362	289	241	181	161	145	116	96.4	82.6
TTI11005 (50)	1.0	UC	1.14	342	274	228	195	171	137	114	85.5	76.0	68.4	54.7	45.6	39.1
	2.0	UC	1.61	483	386	322	276	242	193	161	121	107	96.6	77.3	64.4	55.2
	3.0	UC	1.97	591	473	394	338	296	236	197	148	131	118	94.6	78.8	67.5
	4.0	UC	2.27	681	545	454	389	341	272	227	170	151	136	109	90.8	77.8
	5.0	XC	2.54	762	610	508	435	381	305	254	191	169	152	122	102	87.1
	6.0	XC	2.79	837	670	558	478	419	335	279	209	186	167	134	112	95.7
	7.0	XC	3.01	903	722	602	516	452	361	301	226	201	181	144	120	103
TTI11006 (50)	1.0	UC	1.37	411	329	274	235	206	164	137	103	91.3	82.2	65.8	54.8	47.0
	2.0	UC	1.94	582	466	388	333	291	233	194	146	129	116	93.1	77.6	66.5
	3.0	UC	2.37	711	569	474	406	356	284	237	178	158	142	114	94.8	81.3
	4.0	UC	2.74	822	658	548	470	411	329	274	206	183	164	132	110	93.9
	5.0	XC	3.06	918	734	612	525	459	367	306	230	204	184	147	122	105
	6.0	XC	3.35	1005	804	670	574	503	402	335	251	223	201	161	134	115
	7.0	XC	3.62	1086	869	724	621	543	434	362	272	241	217	174	145	124

Kontakti preparati	Sistemići	Upravljanje zanošenjem
-	UZVRNSNO	IZVRNSNO



Optimalni odnos razmaka diza i visina prilikom prskanja





DIZE ZA PRSKALICE

TIP DIZE	KAT. BROJ
Diza TeeJet XR-11002VP	202556
Diza TeeJet XR-11003VP	202557
Diza TeeJet XR-11004VP	202674



MLAZ NA PRITISKU 1 bar

MLAZ NA PRITISKU 2 bara



10

Diza	bar	vel. kapilice**	kapacitet po dizi	l/ha Δ 50cm												
				4 km/h	5 km/h	6 km/h	7 km/h	8 km/h	9 km/h	10 km/h	12 km/h	16 km/h	20 km/h	25 km/h	30 km/h	35 km/h
XR8001 XR11001 (100)	1.0	F	0.23	69.0	55.2	46.0	39.4	34.5	27.6	23.0	17.3	15.3	13.8	11.0	9.2	7.9
	1.5	F	0.28	84.0	67.2	56.0	48.0	42.0	33.6	28.0	21.0	18.7	16.8	13.4	11.2	9.6
	2.0	F	0.32	96.0	76.8	64.0	54.9	48.0	38.4	32.0	24.0	21.3	19.2	15.4	12.8	11.0
	3.0	F	0.39	117	93.6	78.0	66.9	58.5	46.8	39.0	29.3	26.0	23.4	18.7	15.6	13.4
XR8001S XR11001S (100)	1.0	M	0.34	102	81.6	68.0	58.3	51.0	40.8	34.0	25.5	22.7	20.4	16.3	13.6	11.7
	1.5	M	0.42	126	101	84.0	72.0	63.0	50.4	42.0	31.5	28.0	25.2	20.2	16.8	14.4
	2.0	M	0.48	144	115	96.0	82.3	72.0	57.6	48.0	36.0	32.0	28.8	23.0	19.2	16.5
	3.0	M	0.59	177	142	118	101	88.5	70.8	59.0	44.3	39.3	35.4	28.3	23.6	20.2
XR8002 XR11002 (50)	1.0	M	0.46	138	110	92.0	78.9	69.0	55.2	46.0	34.5	30.7	27.6	22.1	18.4	15.8
	1.5	M	0.56	168	134	112	96.0	84.0	67.2	56.0	42.0	37.3	33.6	26.9	22.4	19.2
	2.0	M	0.65	195	156	130	111	97.5	78.0	65.0	48.8	43.3	39.0	31.2	26.0	22.3
	3.0	M	0.79	237	190	158	135	119	94.8	79.0	59.3	52.7	47.4	37.9	31.6	27.1
XR8002S XR11002S (50)	1.0	M	0.57	171	137	114	97.7	85.3	68.4	57.0	42.8	38.0	34.2	27.4	22.8	19.5
	1.5	M	0.70	210	168	140	120	105	84.0	70.0	52.5	46.7	42.0	33.6	28.0	24.0
	2.0	M	0.81	243	194	162	139	122	97.2	81.0	60.8	54.0	48.6	38.9	32.4	27.8
	3.0	M	0.99	297	238	198	170	149	119	99.0	74.3	66.0	59.4	47.5	39.6	33.9
XR8003 XR11003 (50)	1.0	M	0.68	204	163	136	117	102	81.6	68.0	51.0	45.3	40.8	32.6	27.2	23.3
	1.5	M	0.83	249	199	166	142	125	99.6	83.0	62.3	55.3	49.8	39.8	33.2	28.5
	2.0	M	0.96	288	230	192	165	144	115	96.0	72.0	64.0	57.6	46.1	38.4	32.9
	3.0	M	1.08	324	259	216	185	162	130	108	81.0	72.0	64.8	51.8	43.2	37.0
XR8003S (50)	1.0	M	0.86	240	192	160	137	120	96.0	80.0	60.0	53.3	48.0	38.4	32.0	27.4
	1.5	M	0.98	294	235	196	168	147	118	98.0	73.5	65.3	58.8	47.0	39.2	33.6
	2.0	M	1.13	339	271	226	194	170	136	113	84.8	75.3	67.8	54.2	45.2	38.7
	3.0	M	1.26	378	302	252	216	189	151	126	94.5	84.0	75.6	60.5	50.4	43.2
XR8004 XR11004 (50)	1.0	C	0.91	237	189	156	137	120	96.0	80.0	60.0	53.3	48.0	38.4	32.0	27.4
	1.5	M	1.12	336	269	224	192	168	134	112	84.0	74.7	67.2	53.8	44.8	38.4
	2.0	M	1.29	387	310	258	221	194	155	129	96.8	86.0	77.4	61.9	51.6	44.2
	3.0	M	1.58	474	379	316	271	237	190	158	119	105	94.8	75.8	63.2	54.2
XR8005 XR11005 (50)	1.0	C	1.14	342	274	228	195	171	137	114	85.5	76.0	68.4	54.7	45.6	39.1
	1.5	M	1.39	417	334	278	238	209	167	139	104	92.7	83.4	66.7	55.6	47.7
	2.0	M	1.61	483	386	322	276	242	193	161	121	107	96.6	77.3	64.4	55.2
	3.0	M	1.80	540	432	360	309	270	216	180	135	120	108	86.4	72.0	61.7
XR8006 XR11006 (50)	1.0	C	1.37	411	329	274	235	206	164	137	103	91.3	82.2	65.8	54.8	47.0
	1.5	M	1.68	504	403	336	288	252	202	168	126	112	101	80.6	67.2	57.6
	2.0	M	1.94	582	466	388	333	291	233	194	146	129	116	93.1	77.6	66.5
	3.0	M	2.16	648	518	432	370	324	259	216	162	144	130	104	86.4	74.1
XR8008 XR11008 (50)	1.0	VC	1.82	546	437	364	312	273	218	182	137	121	109	87.4	72.8	62.4
	1.5	VC	2.23	669	535	446	382	335	268	223	167	149	134	107	89.2	76.5
	2.0	C	2.58	774	619	516	442	387	310	258	194	172	155	124	103	88.5
	3.0	M	3.16	948	758	632	542	474	379	316	237	211	190	152	126	108
XR8010 [†] XR11010 [†]	1.0	XC	2.28	684	547	456	391	342	274	228	171	152	137	109	91.2	78.2
	1.5	XC	2.79	837	670	558	478	419	335	279	209	186	167	134	112	95.7
	2.0	C	3.23	969	775	646	554	485	388	323	242	215	194	155	129	111
	3.0	M	3.61	1083	866	722	619	542	433	361	271	241	217	173	144	124
XR8015 [†] XR11015 [†]	1.0	XC	3.42	1026	821	684	586	513	410	342	257	228	205	164	137	117
	1.5	XC	4.19	1257	1006	838	718	629	503	419	314	279	251	201	168	144
	2.0	VC	4.83	1449	1159	966	828	725	580	483	362	322	290	232	193	166
	3.0	M	5.40	1620	1296	1080	926	810	648	540	405	360	324	259	216	185



Optimalni odnos razmaka diza i visina prilikom prskanja

razmak	visina
80°	75 cm
110°	50 cm

Kontakti preparati	Sistemici	Upravljanje zanošenjem
IZVRSNO	DOBRO	DOBRO
DOBRO*	VRLO DOBRO*	VRLO DOBRO*

*Na pritisku ispod 2 bara!



DIZE ZA PRSKALICE

TIP DIZE	KAT. BROJ
Diza TeeJet TXA-8001VK	202706
Diza TeeJet TXA-8002VK	202707
Diza TeeJet TXA-8003VK	202676
Diza TeeJet TXA-8004VK	202675

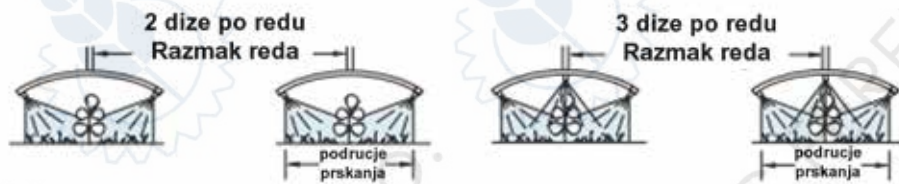

Izbor	l/ha x FAKTOR*	
	50cm	75cm
20 cm	2.50	3.75
25 cm	2.00	3.00
30 cm	1.67	2.50
40 cm	1.25	1.88

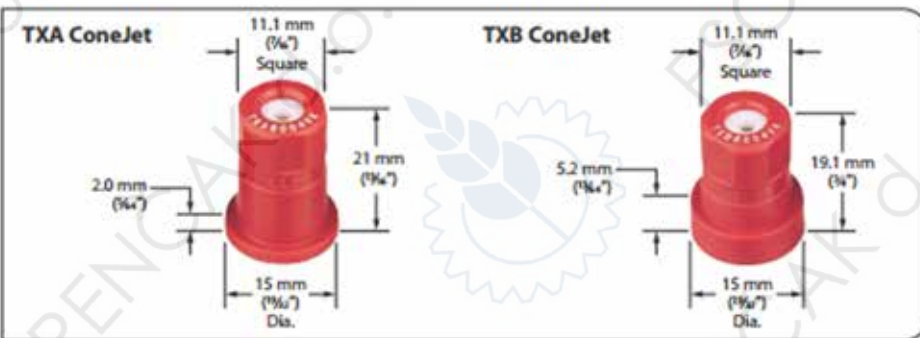

*Faktor za izračun potrošnje
Potrošnja=razmak među redovima x faktor



Diza	bar	vel. kapilice**	kapacitet za 2 dize l/min	l/ha 50 cm				l/ha 75 cm				bar	kapacitet za 2 dize l/min	l/ha 50 cm				l/ha 75 cm																																																																																							
				4	6	8	10	4	6	8	10			4	6	8	10	4	6	8	10																																																																																				
				km/h	km/h	km/h	km/h	km/h	km/h	km/h	km/h			km/h	km/h	km/h	km/h	km/h	km/h	km/h	km/h	km/h	km/h	km/h	km/h																																																																																
TXA800050VK TXB800050VK (100)	5.0	VF	0.50	150	100	75.0	60.0	100	66.7	50.0	40.0	5.0	0.75	225	150	113	90.0	150	100	75.0	60.0	7.0	VF	0.56	168	112	84.0	67.2	112	74.7	56.0	44.8	7.0	0.84	252	168	126	101	168	112	84.0	67.2	10.0	VF	0.66	198	132	99.0	79.2	132	88.0	66.0	52.8	10.0	0.99	297	198	149	119	198	132	99.0	79.2	15.0	VF	0.78	234	156	117	93.6	156	104	78.0	62.4	15.0	1.17	351	234	176	140	234	156	117	93.6	20.0	VF	0.90	270	180	135	108	180	120	90.0	72.0	20.0	1.35	405	270	203	162	270	180	135	108
	5.0	VF	0.66	198	132	99.0	79.2	132	88.0	66.0	52.8	5.0	0.99	297	198	149	119	198	132	99.0	79.2	7.0	VF	0.78	234	156	117	93.6	156	104	78.0	62.4	7.0	1.17	351	234	176	140	234	156	117	93.6	10.0	VF	0.90	270	180	135	108	180	120	90.0	72.0	10.0	1.35	405	270	203	162	270	180	135	108	15.0	VF	1.10	330	220	165	132	220	147	110	88.0	15.0	1.65	495	330	258	198	330	220	165	132	20.0	VF	1.24	372	248	186	149	248	165	124	99.2	20.0	1.86	558	372	279	223	372	248	186	149
	5.0	VF	1.00	300	200	150	120	200	133	100	80.0	5.0	1.50	450	300	225	180	300	200	150	120	7.0	VF	1.16	348	232	174	139	232	155	116	92.8	7.0	1.74	522	348	261	209	348	232	174	139	10.0	VF	1.36	408	272	204	163	272	181	136	109	10.0	2.04	612	408	306	245	408	272	204	163	15.0	VF	1.64	492	328	246	197	328	219	164	131	15.0	2.46	738	492	369	295	492	328	246	197	20.0	VF	1.86	558	372	279	223	372	248	186	149	20.0	2.79	837	558	419	335	558	372	279	223
	5.0	F	1.50	450	300	225	180	300	200	150	120	5.0	2.25	675	450	338	270	450	300	225	180	7.0	VF	1.76	528	352	264	211	352	235	176	141	7.0	2.64	792	528	396	317	528	352	264	211	10.0	VF	2.00	600	400	300	240	400	267	200	160	10.0	3.00	900	600	450	360	600	400	300	240	15.0	VF	2.60	780	520	390	312	520	347	260	208	15.0	3.90	1170	780	585	468	780	520	390	312	20.0	VF	3.00	900	600	450	360	600	400	300	240	20.0	4.50	1350	900	675	540	900	600	450	360
5.0	VF	2.00	600	400	300	240	400	267	200	160	5.0	3.00	900	600	450	360	600	400	300	240	7.0	VF	2.40	720	480	360	288	480	320	240	192	7.0	3.60	1080	720	540	432	720	480	360	288	10.0	VF	2.80	840	560	420	336	560	373	280	224	10.0	4.20	1260	840	630	504	840	560	420	336	15.0	VF	3.40	1020	680	510	408	680	453	340	272	15.0	5.10	1530	1020	765	612	1020	680	510	408	20.0	VF	4.00	1200	800	600	480	800	533	400	320	20.0	6.00	1800	1200	900	720	1200	800	600	480	
5.0	F	3.00	900	600	450	360	600	400	300	240	5.0	4.50	1350	900	675	540	900	600	450	360	7.0	VF	3.60	1080	720	540	432	720	480	360	288	7.0	5.40	1620	1080	810	648	1080	720	540	432	10.0	VF	4.40	1320	880	660	528	880	587	440	352	10.0	6.60	1980	1320	990	792	1320	880	660	528	15.0	VF	5.20	1560	1040	780	624	1040	693	520	416	15.0	7.80	2340	1560	1170	936	1560	1040	780	624	20.0	VF	6.00	1800	1200	900	720	1200	800	600	480	20.0	9.00	2700	1800	1350	1080	1800	1200	900	720	
5.0	F	4.20	1260	840	630	504	840	560	420	336	5.0	6.30	1890	1260	945	756	1260	840	630	504	7.0	VF	4.80	1440	960	720	576	960	640	480	384	7.0	7.20	2160	1440	1080	864	1440	960	720	576	10.0	VF	5.80	1740	1160	870	696	1160	773	580	464	10.0	8.70	2610	1740	1305	1044	1740	1160	870	696	15.0	VF	7.20	2146	1440	1080	864	1440	960	720	576	15.0	10.80	3240	2160	1620	1296	2160	1440	1080	864	20.0	VF	8.20	2460	1640	1230	984	1640	1093	820	656	20.0	12.30	3690	2460	1845	1476	2460	1640	1230	984	



DIZE ZA PRSKALICE



TIP DIZE	KAT. BROJ
Diza TeeJet TTJ60-11002VP	202634
Diza TeeJet TTJ60-11003VP	202559
Diza TeeJet TTJ60-11004VP	202560

Tip Dize	bar	vel. kapljice**	kapacitet po dizi l/min	l/ha Δ 50cm												
				4 km/h	5 km/h	6 km/h	7 km/h	8 km/h	9 km/h	10 km/h	12 km/h	16 km/h	20 km/h	25 km/h	30 km/h	35 km/h
TTJ60-11002 (100)	1.5	C	0.56	168	134	112	96.0	84.0	67.2	56.0	42.0	37.3	33.6	26.9	22.4	19.2
	2.0	C	0.65	195	156	130	111	97.5	78.0	65.0	48.8	43.3	39.0	31.2	26.0	22.3
	3.0	C	0.79	237	190	158	135	119	94.8	79.0	59.3	52.7	47.4	37.9	31.6	27.1
	4.0	M	0.91	273	218	182	156	137	109	91.0	68.3	60.7	54.6	43.7	36.4	31.2
	5.0	M	1.02	306	245	204	175	153	122	102	76.5	68.0	61.2	49.0	40.8	35.0
TTJ60-110025 (100)	1.5	VC	0.70	210	168	140	120	105	84.0	70.0	52.5	46.7	42.0	33.6	28.0	24.0
	2.0	C	0.81	243	194	162	139	122	97.2	81.0	60.8	54.0	48.6	38.9	32.4	27.8
	3.0	C	0.99	297	238	198	170	149	119	99.0	74.3	66.0	59.4	47.5	39.6	33.9
	4.0	C	1.14	342	274	228	195	171	137	114	85.5	76.0	68.4	54.7	45.6	39.1
	5.0	M	1.28	384	307	256	219	192	154	128	96.0	85.3	76.8	61.4	51.2	43.9
TTJ60-11003 (100)	1.5	VC	0.83	249	199	166	142	125	99.6	83.0	62.3	55.3	49.8	39.8	33.2	28.5
	2.0	C	0.96	288	230	192	165	144	115	96.0	72.0	64.0	57.6	46.1	38.4	32.9
	3.0	C	1.18	354	283	236	202	177	142	118	88.5	78.7	70.8	56.6	47.2	40.5
	4.0	C	1.36	408	326	272	233	204	163	136	102	90.7	81.6	65.3	54.4	46.6
	5.0	C	1.52	456	365	304	261	228	182	152	114	101	91.2	73.0	60.8	52.1
TTJ60-11004 (50)	1.5	VC	1.12	336	269	224	192	168	134	112	84.0	74.7	67.2	53.8	44.8	38.4
	2.0	C	1.29	387	310	258	221	194	155	129	96.8	86.0	77.4	61.9	51.6	44.2
	3.0	C	1.58	474	379	316	271	237	190	158	119	105	94.8	75.8	63.2	54.2
	4.0	C	1.82	546	437	364	312	273	218	182	137	121	109	87.4	72.8	62.4
	5.0	C	2.04	612	490	408	350	306	245	204	153	136	122	97.9	81.6	69.9
TTJ60-11005 (50)	1.5	VC	1.39	417	334	278	238	209	167	139	104	92.7	83.4	66.7	55.6	47.7
	2.0	C	1.61	483	386	322	276	242	193	161	121	107	96.6	77.3	64.4	55.2
	3.0	C	1.97	591	473	394	338	296	236	197	148	131	118	94.6	78.8	67.5
	4.0	C	2.27	681	545	454	389	341	272	227	170	151	136	109	90.8	77.8
	5.0	C	2.54	762	610	508	435	381	305	254	191	169	152	122	102	87.1
TTJ60-11006 (50)	1.5	XC	1.68	504	403	336	288	252	202	168	126	112	101	80.6	67.2	57.6
	2.0	VC	1.94	582	466	388	333	291	233	194	146	129	116	93.1	77.6	66.5
	3.0	C	2.37	711	569	474	406	356	284	237	178	158	142	114	94.8	81.3
	4.0	C	2.74	822	658	548	470	411	329	274	206	183	164	132	110	93.9
	5.0	C	3.06	918	734	612	525	459	367	306	230	204	184	147	122	105
6.0	C	3.35	1005	804	670	574	503	402	335	251	223	201	161	134	115	

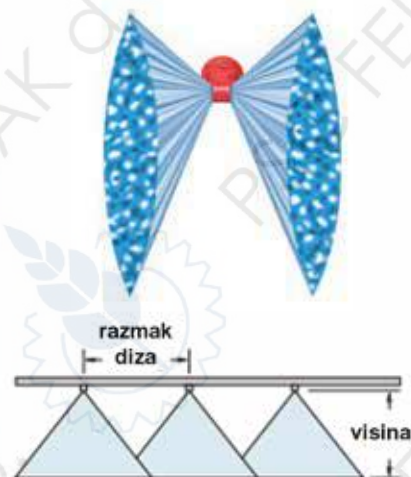

Optimalni odnos razmaka diza i visina prilikom prskanja

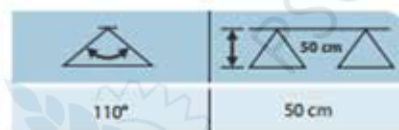

Kontakti preparati	Sistemici	Upravljanje zanošenjem
IZVRSN0	IZVRSN0	VRLO DOBRO
VRLO DOBRO***	IZVRSN0***	IZVRSN0***















*** Na pritisku ispod 2 bara!

OSTALI DIJELOVI ZA PRSKALICE

ŠIFRA	NAZIV	KAT. BR.	ŠIFRA	NAZIV	KAT. BR.
202640	Nosač dize TeeJet jednostruki		010137	Tijelo dize atomizera R 1/4 mesing	020.50.014
202570	Matica dize s gumicom 8 mm TeeJet		200190	Sito dize s ventilom 50 Msh	
202571	Matica dize s gumicom 11 mm TeeJet		010026	Matica membran-ske dize	017.01.057
194184	Nosač dize sa membranom (talijanski model)				
010136	Nosač dize sa membranom (Agromehanika)				



OSTALI DIJELOVI ZA PRSKALICE

ŠIFRA	NAZIV	KAT.BR.	ŠIFRA	NAZIV	KAT.BR.
010421	Matica dize	017.01.131	194183	Nosač dize obični	
					
195968	Matica dize za talijanski model 3/8"		194185	Nosač dize sa membranom triplet (talijanski model)	
			194475	Nosač dize sa membranom triplet (Agromehanika)	
202641	Nosač dize TeeJet peterostruki				
			010214	Ventil protukapni s oprugom i kuglicom	
					
010068	Matica membranske dize	019.01.115	010059	Sito dize bez ventila 24Msh	
					
192866	Matica dize PVC M18x1,5	017.01.041	201446	Matica dize Rau	
					
202848	Matica dize (novi tip)	019.01.234	202968	Matica dize Rau (s navojem)	
					
010060	Poklopac Ø 230 rezervoara PVC Agromehanika		010058	Cjedilo rezervoara Agromehanika	
					
192043	Poklopac rezervoara gumeni Agromehanika				



10



Vršimo popravak pumpi prskalica uz ugradnju originalnih dijelova.



Obavite servisiranje pumpe prskalice na vrijeme (prije sezone prskanja, ali i prije pospremanja preko zime), kako bi ste izbjegli neželjene kvarove. Za sva pitanja ili nedoumice nas kontaktirajte putem telefona ili elektronske pošte na adresu info@psc-ferencak.hr.





Prostor za bilješke

10

PSC ferencak





Strana

DIJELOVI ZA ROTO KOSE

CLASS	140
DEUTZ-FAHR	140-141
FELLA	142
KRONE	142-143
KUHN	143
NIEMEYER	143
PÖTTINGER	143
SIP	144
VICON-PZ	144-146
TIPOVI NOŽEVA ZA ROTO KOSE	147

11



ROTO KOSE

CLAAS

ŠIFRA	NAZIV	KAT.BR.	
192236	Nož roto kose Claas D	410133	
202490	Nož roto kose Claas L	410134	
197193	Nož roto kose Claas D	410151	
202491	Nož roto kose Claas L	410150	
199259	Nož roto kose Claas D	41015425	
200412	Nož roto kose Claas L	41015525	
200414	Nož roto kose Claas D	41015225	
200415	Nož roto kose Claas L	41015325	
198388	Nosač noža Claas	411606	
197954	Nosač noža Claas	411140	
197955	Nosač noža Claas	411141	
199178	Nosač noža Claas	411135	
192765	Nosač noža Claas	411130	
199248	Nosač noža Claas	411604	
197406	Vijak noža Claas	411554	

ROTO KOSE

CLAAS

ŠIFRA	NAZIV	KAT.BR.	
199255	Vijak noža Claas	411403	
198241	Vijak noža Claas	411402	

ROTO KOSE

DEUTZ - FAHR

ŠIFRA	NAZIV	KAT.BR.	
199131	Nož roto kose Deutz-Fahr D/L 96x40x3		
197946	Nož roto kose Deutz-Fahr D/L		
080036	Nož roto kose Deutz-Fahr D/L 90x40x3		
200416	Nož roto kose Deutz-Fahr 96x40x3		
196556	Nož roto kose Deutz-Fahr 128x48x4 D		
200544	Nož roto kose Deutz-Fahr 128x48x4 L		
200410	Nož roto kose Deutz-Fahr 96x40x34 D		
200411	Nož roto kose Deutz-Fahr 96x40x3 L		
200439	Nož roto kose Deutz-Fahr 128x48x4 D		
200440	Nož roto kose Deutz-Fahr 128x48x4 L		







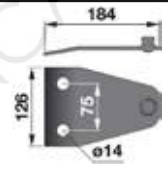
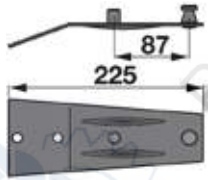
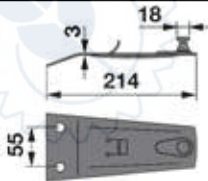
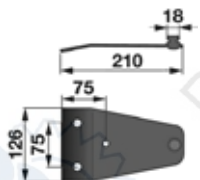
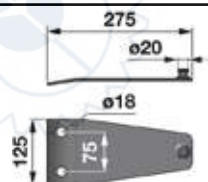
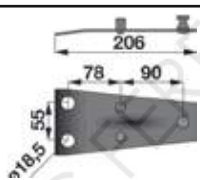
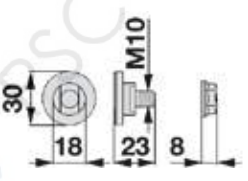
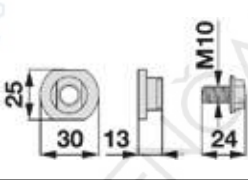
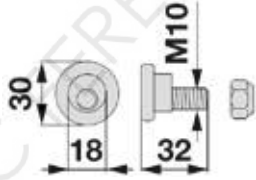
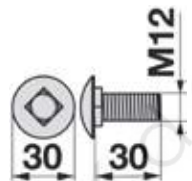

11

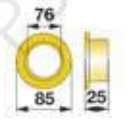
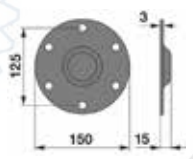

ROTO KOSE DEUTZ - FAHR

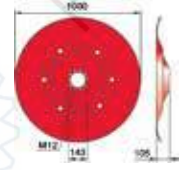
ŠIFRA	NAZIV	KAT.BR.
198388	Nosač noža Deutz-Fahr	
199104	Nosač noža Deutz-Fahr	
198387	Nosač noža Deutz-Fahr	
197260	Nosač noža Deutz-Fahr	
199248	Nosač noža Deutz-Fahr	
202956	Nosač noža Deutz-Fahr	
196563	Vijak noža Deutz-Fahr	
198242	Vijak noža Deutz-Fahr	
197968	Vijak noža Deutz-Fahr	
199190	Vijak noža Deutz-Fahr	

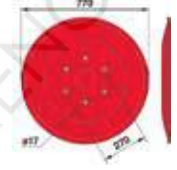
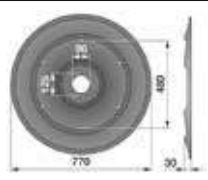
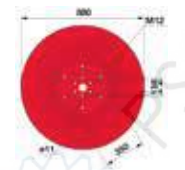
ROTO KOSE DEUTZ - FAHR

ŠIFRA	NAZIV	KAT.BR.
199247	Čahura roto kose Deutz-Fahr	
199334	Čahura roto kose Deutz-Fahr	
199189	Čahura roto kose Deutz-Fahr	
198597	Poklopac roto kose Deutz-Fahr	
198389	Vrat roto kose Deutz-Fahr	
193532	Disk roto kose Deutz-Fahr	
194150	Disk roto kose Deutz-Fahr	
199390	Disk roto kose Deutz-Fahr	
201264	Disk roto kose Deutz-Fahr	
201665	Disk roto kose Deutz-Fahr	
191411	Remen roto kose Deutz-Fahr KM 22	
199476	Remen roto kose Deutz-Fahr KM 24	

11



ROTO KOSE FELLA

ŠIFRA	NAZIV	
197951	Nož roto kose Fella	
200488	Nož roto kose Fella D	
199697	Nož roto kose Fella L	
199698	Nož roto kose Fella D	
202492	Nož roto kose Fella L	
196480	Nož roto kose Fella	
198789	Nož roto kose Fella	
197397	Nož roto kose Fella	
203408	Nož roto kose Fella	
201476	Nož roto kose Fella	
201811	Vijak noža Fella M10x20	
201814	Vijak noža Fella M10x30	
201812	Vijak noža Fella M10x35	
196481	Čahura noža kose Fella	
197945	Disk roto kose Fella 770x87	
202814	Disk roto kose Fella 870x30	

ROTO KOSE KRONE

ŠIFRA	NAZIV	KAT.BR.	
196091	Nož roto kose Krone D zamjenski		
196090	Nož roto kose Krone L zamjenski		
197031	Nož roto kose Krone D		
197030	Nož roto kose Krone L		
196130	Nož roto kose Krone D		
200234	Nož roto kose Krone L		
199188	Nož roto kose Krone D		
202762	Nož roto kose Krone L		
199241	Nosač noža Krone		
197947	Vijak M10x20		
196088	Nosač noža Krone		
194072	Vijak M10x25		
196089	Vijak M10x16		
199105	Nosač noža Krone		
199106	Vijak M12x35		
196522	Nosač noža Krone	411612	
197260	Nosač noža Krone	411607	
197405	Vijak noža Krone		
197406	Vijak noža Krone		

11



ROTO KOSE KRONE

ŠIFRA	NAZIV	KAT.BR.
203427	Vijak noža Krone	
199107	Klizač roto kose Krone	
197944	Disk roto kose Krone	
201423	Disk roto kose Krone	

ROTO KOSE KUHN

ŠIFRA	NAZIV	KAT.BR.
199699	Nož roto kose Kuhn D	
199700	Nož roto kose Kuhn L	
200232	Nož roto kose Kuhn D	
194607	Nož roto kose Kuhn L	
197101	Nož roto kose Kuhn D	
200329	Nož roto kose Kuhn L	
196160	Vijak noža roto kose Kuhn	
198241	Vijak noža roto kose Kuhn	
202806	Vijak noža roto kose Kuhn	

ROTO KOSE NIEMEYER

ŠIFRA	NAZIV	KAT.BR.
080036	Nož roto kose Niemeayer	
199701	Nož roto kose Niemeayer D	
199702	Nož roto kose Niemeayer L	
197397	Nosač noža roto kose Niemeayer	

ROTO KOSE PÖTTINGER

ŠIFRA	NAZIV	KAT.BR.
199240	Nož roto kose Pöttinger	
198646	Nož roto kose Pöttinger D	
201912	Nož roto kose Pöttinger L	
202933	Nož roto kose Pöttinger D	410584
202934	Nož roto kose Pöttinger L	410585
199335	Nosač noža roto kose Pöttinger	411557
201724	Nosač noža roto kose Pöttinger	434712
196609	Vijak noža roto kose Pöttinger	
199108	Vijak noža roto kose Pöttinger	
197406	Vijak noža roto kose Pöttinger	
200279	Vijak noža roto kose Pöttinger	411807

11



ROTO KOSE SIP

ŠIFRA	NAZIV	KAT.BR.
-------	-------	---------

199124	Nož roto kose Sip	
--------	-------------------	--



080019	Nož roto kose Sip	
--------	-------------------	--

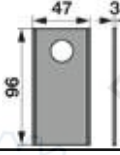

199132	Nož roto kose Sip D	
--------	---------------------	--

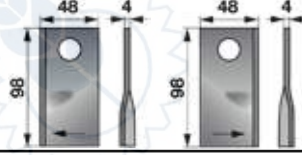

199133	Nož roto kose Sip L	
--------	---------------------	--



196141	Nož roto kose Sip D	
--------	---------------------	--

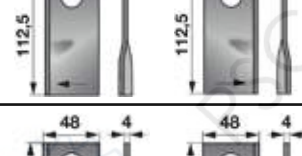

196142	Nož roto kose Sip L	
--------	---------------------	--

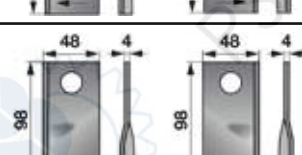

200488	Nož roto kose Sip D	
--------	---------------------	--



199697	Nož roto kose Sip L	
--------	---------------------	--



080032	Nosač noža roto kose Sip RK 135	
--------	---------------------------------	--



199112	Nosač noža roto kose Sip RK 165	
--------	---------------------------------	--



193555	Nosač noža roto kose Sip RK 185	
--------	---------------------------------	--



199248	Nosač noža roto kose Sip	
--------	--------------------------	--

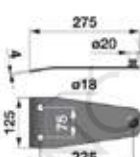

200295	Nosač noža roto kose Sip	
--------	--------------------------	--



050166	Vijak noža roto kose Sip	
--------	--------------------------	--

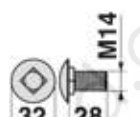

ROTO KOSE SIP

ŠIFRA	NAZIV	KAT.BR.
-------	-------	---------

190299	Disk roto kose Sip	
--------	--------------------	--



202893	Disk roto kose Sip zamjenski	
--------	------------------------------	--

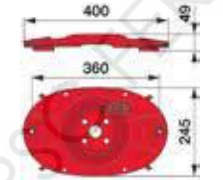

100230	Vijak M10	
--------	-----------	--

201913	Disk roto kose Sip	
--------	--------------------	--

194155	Osovina roto kose Sip	
--------	-----------------------	--



080051	Remen kose Sip 135	
--------	--------------------	--



197138	Remen kose Sip 165	
--------	--------------------	--

ROTO KOSE VICON - PZ

ŠIFRA	NAZIV	KAT.BR.
-------	-------	---------

198889	Nož roto kose Vicon D	
--------	-----------------------	--

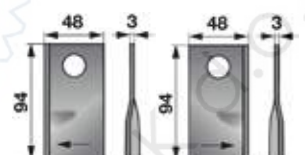

200235	Nož roto kose Vicon L	
--------	-----------------------	--

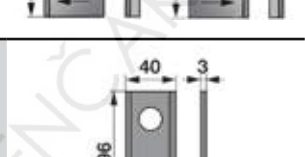

197946	Nož roto kose Vicon	
--------	---------------------	--

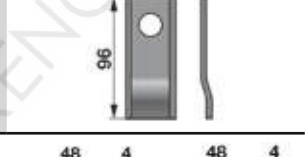

196141	Nož roto kose Vicon D	
--------	-----------------------	--

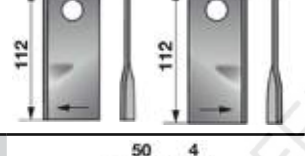

196142	Nož roto kose Vicon L	
--------	-----------------------	--

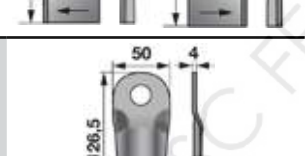

194426	Nož roto kose Vicon (za kamenite uvjete)	
--------	--	--

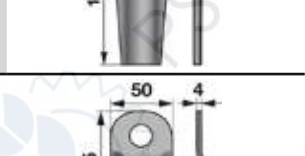









197603	Nož roto kose Vicon (za kamenite uvjete)	
--------	--	--



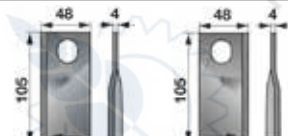
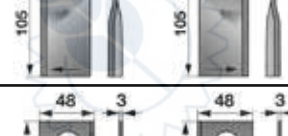
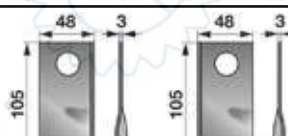
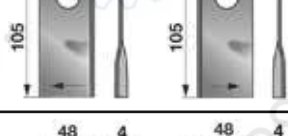
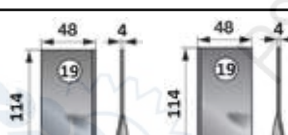

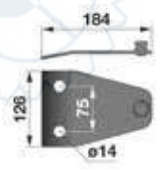
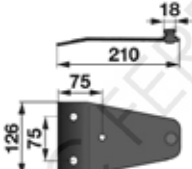
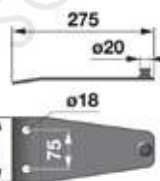
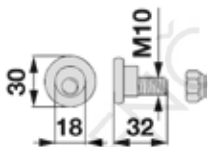
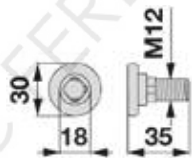





ROTO KOSE VICON - PZ

ŠIFRA	NAZIV	KAT.BR.
196556	Nož roto kose Vicon D	
200544	Nož roto kose Vicon L	
195637	Nož roto kose Vicon D	
195638	Nož roto kose Vicon L	
202692	Nož roto kose Vicon D	
202693	Nož roto kose Vicon L	
202993	Nož roto kose Vicon D	
202970	Nož roto kose Vicon L	
202989	Nož roto kose Vicon D	
202990	Nož roto kose Vicon L	
198338	Nosač noža roto kose Vicon	
197260	Nosač noža roto kose Vicon	
199248	Nosač noža roto kose Vicon	
197968	Vijak noža roto kose Vicon	
193019	Vijak noža roto kose Vicon	
199248	Plastična čahura roto kose Vicon	

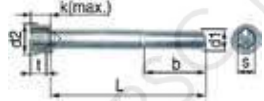
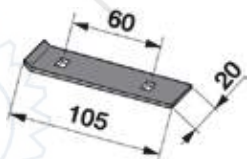
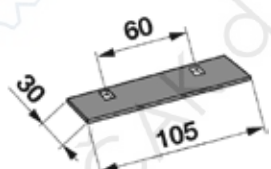
ROTO KOSE VICON - PZ

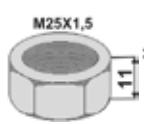
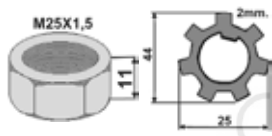
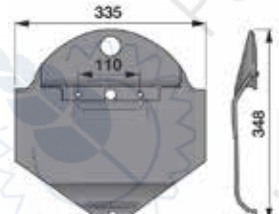
ŠIFRA	NAZIV	KAT.BR.
192270	Zupčanik roto kose Vicon	
194437	Zupčanik roto kose Vicon	
195400	Zupčanik roto kose Vicon	
197259	Kućište ležaja roto kose Vicon	
100230	Vijak imbus M10	
198647	Udarana ploča Vicon	
198648	Udarana ploča Vicon	
197158	Remen Vicon (original)	
199204	Remen Tagex (zamjenski)	
197874	Podloška krunasta	
190991	Vijak M25	
196619	Klizač roto kose Vicon (VN18613483)	

11



ROTO KOSE

VICON - PZ

ROTO KOSE

VICON - PZ

ŠIFRA	NAZIV	KAT.BR.	ŠIFRA	NAZIV	KAT.BR.
196733	Disk roto kose Vicon (VNB2280294)		199371	Disk roto kose Vicon	
196620	Disk roto kose Vicon (VNB2280594)		199175	Disk roto kose Vicon	
199238	Disk roto kose Vicon				

11





TIPOVI NOŽEVA ROTO KOSA

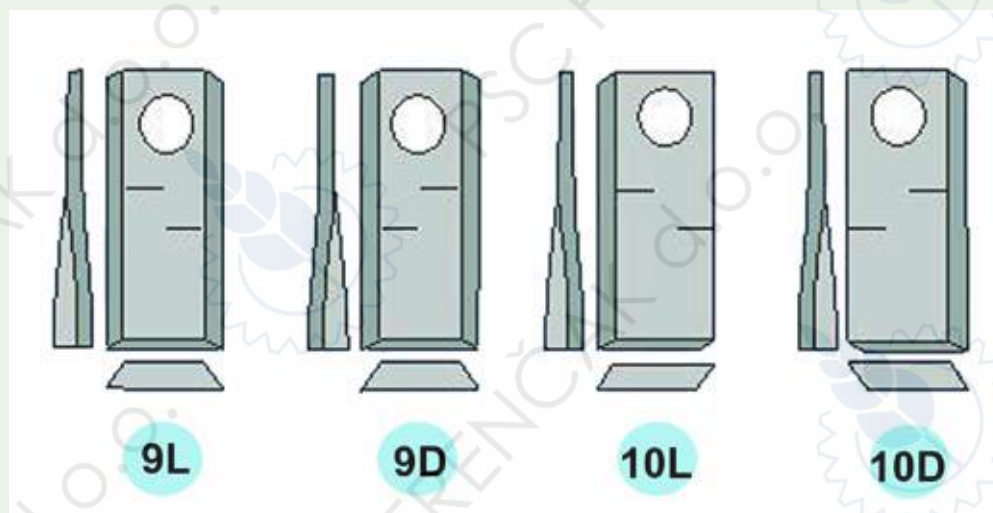
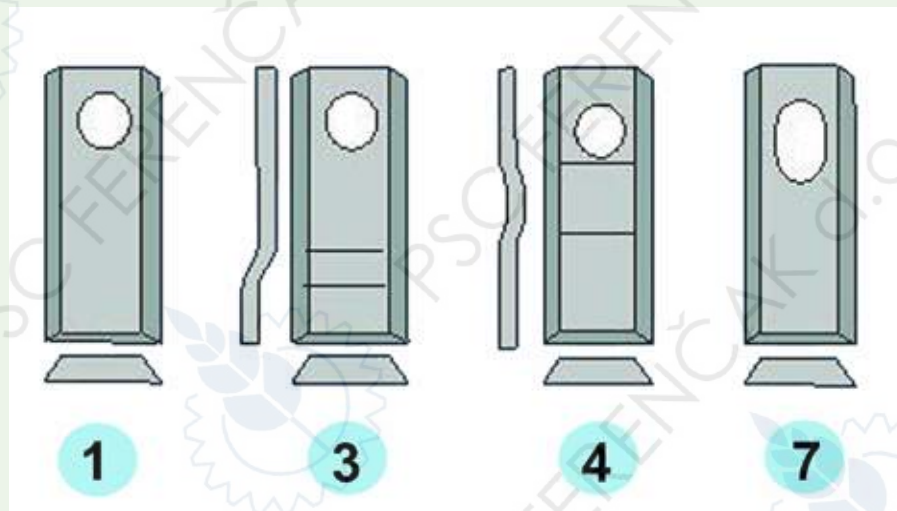

L- lijevi nož D-desni nož

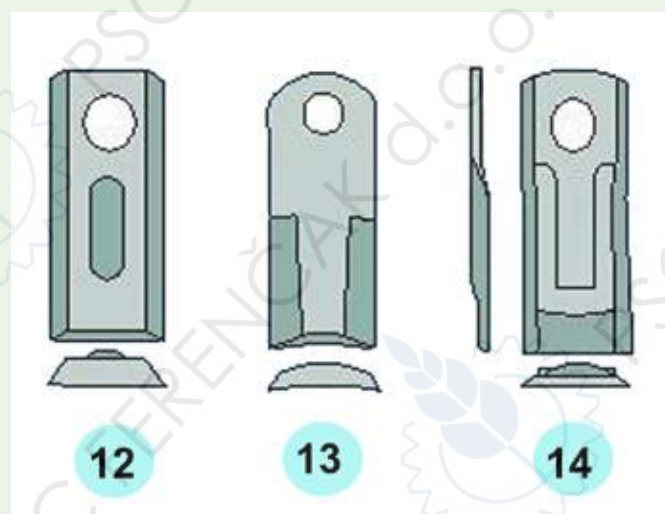

Prilikom narudžbe noževa obratite pažnju na TIP NOŽA i na karakteristične DIMENZIJE (duljina, širina, debljina). Kako bi Vam se pojednostavila narudžba (koristite se primjerom na sljedećoj strani).



**Za narudžbu ili upite o specijaliziranim dijelovima
pripremite podatke označene na slikama:**

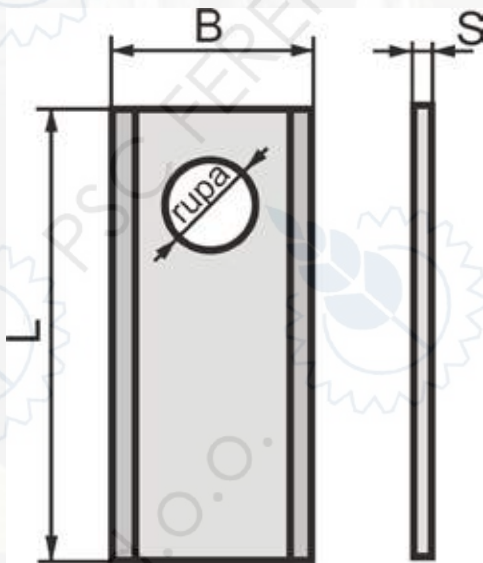

Primjer mjerenja karakterističnih dimenzija noža.

Kod broja slike navedite oblik noža koji naručujete prema slici sa prethodne stranice.

11

L _____

B _____

S _____

Promjer rupe _____

Proizvođač _____

Tip _____

Količina _____

Slika br. _____

L _____

B _____

S _____

Promjer rupe _____

Proizvođač _____

Tip _____

Količina _____

Slika br. _____

Za sva pitanja ili nedoumice nas kontaktirajte dolaskom u naše poljoprivredno-servisne centre u Križevcima, Koprivnici, Bjelovaru, Virovitici i Osijeku, putem telefona ili elektronske pošte na adresu info@psc-ferencak.hr.



Prostor za bilješke

11

PSC ferencak





Strana

DIJELOVI ZA OKRETAČE

CLASS	152
DEUTZ-FAHR	152-153
FELLA	153
KRONE	153
KUHN	154
NIEMEYER	154
PÖTTINGER	154-155
SIP	156
STOLL	156

12



OKRETAČI CLAAS

ŠIFRA	NAZIV	KAT.BR.
196084	Opruga okretača Claas	
199709	Opruga okretača Claas D	
199710	Opruga okretača Claas L	
199708	Opruga okretača Claas	
200326	Opruga okretača Claas	

OKRETAČI DEUTZ - FAHR

ŠIFRA	NAZIV	KAT.BR.
202999	Osigurač opruge okretača Deutz-Fahr	
196082	Držač opruge okretača Deutz-Fahr	
198293	Držač opruge okretača Deutz-Fahr	
202835	Držač opruge okretača Deutz-Fahr	
198782	Držač opruge okretača Deutz-Fahr KPL	

12

OKRETAČI DEUTZ - FAHR

ŠIFRA	NAZIV	KAT.BR.
202498	Opruga okretača Deutz-Fahr D bijela	
195855	Opruga okretača Deutz-Fahr L crvena	
145477	Opruga okretača Deutz-Fahr	
201305	Opruga okretača Deutz-Fahr	
197309	Opruga okretača Deutz-Fahr	
199059	Osigurač opruge okretača Deutz-Fahr	

198649	Zglob za okretače Deutz-Fahr	
196053	Zglob za okretače Deutz-Fahr	
192268	Sklopka okretača Deutz-Fahr	
197825	Sklopka okretača Deutz-Fahr	
197128	Svornjak okretača Deutz-Fahr	
197129	Obruč ležajni Deutz-Fahr	



OKRETAČI DEUTZ - FAHR

ŠIFRA	NAZIV	KAT.BR.
197826	Osovinica okretača Deutz-Fahr	
198390	Čahura ležajna Deutz-Fahr	
199109	Osovina ležaja okretača Deutz-Fahr	
199173	Čahutra okretača Deutz-Fahr	
199243	Poklopac PVC okretača Deutz-Fahr	
199245	Ležaj aksijalni Deutz-Fahr	
201735	Ležaj aksijalni Deutz-Fahr	
199246	Ležaj aksijalni Deutz-Fahr	
201267	Ležaj aksijalni Deutz-Fahr	
196558	Ležaj kotača Deutz-Fahr	
200408	Pušnica s mazalicom Deutz-Fahr	



OKRETAČI FELLA

ŠIFRA	NAZIV	KAT.BR.
196606	Opruga okretača Fella D (zelena)	
200325	Opruga okretača Fella L (crvena)	
197105	Opruga okretača Fella ravna	
199046	Opruga okretača Fella	
196159	Opruga okretača Fella D (zelena)	401341
201668	Opruga okretača Fella L (bijela)	401340
197110	Držać opruge okretača Fella	20122795
202860	Držać opruge okretača Fella	00404256

12

OKRETAČI KRONE

ŠIFRA	NAZIV	KAT.BR.
195799	Opruga okretača Krone D (zelena)	
200327	Opruga okretača Krone L (žuta)	
199252	Vijak držaća opruge Krone	
199251	Podložna pločica opruge Krone	
199250	Osigurač opruge Krone	



OKRETAČI KUHN

ŠIFRA	NAZIV	KAT.BR.
195854	Opruga okretača Kuhn	
197879	Opruga okretača Kuhn	
194157	Opruga okretača Kuhn	
201543	Opruga okretača Kuhn	
201344	Opruga okretača Kuhn D (crna)	
201343	Opruga okretača Kuhn L (bijela)	
195854	Opruga okretača Kuhn	
192008	Osovina zgloba okretača Kuhn	
192027	Čahura okretača Kuhn	
194156	Držač opruge okretača	











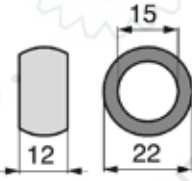
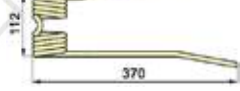
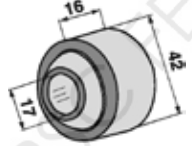
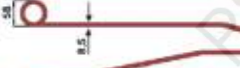

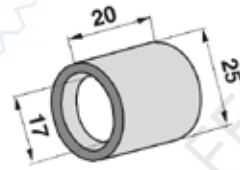

OKRETAČI NIEMEYER

ŠIFRA	NAZIV	KAT.BR.
192768	Opruga okretača Niemeyer D (crvena)	
201835	Opruga okretača Niemeyer L (žuta)	
197108	Opruga okretača Niemeyer D (crvena)	
202572	Opruga okretača Niemeyer L (žuta)	
197950c	Opruga okretača Niemeyer D (crvena)	
197950ž	Opruga okretača Niemeyer L (žuta)	
201487	Držač opruge okretača Niemeyer	
197128	Svornjak okretača Niemeyer	
193602	Čahura okretača Niemeyer	

OKRETAČI PÖTTINGER

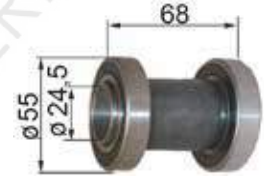
ŠIFRA	NAZIV	KAT.BR.
195477	Opruga okretača Pöttinger	
197107	Opruga okretača Pöttinger	

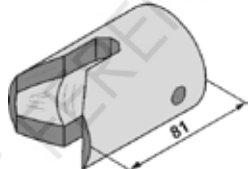
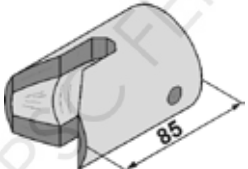
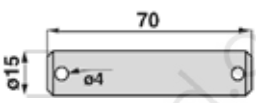
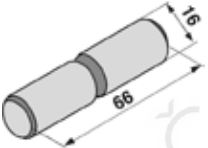

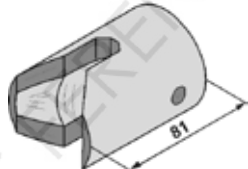
OKRETAČI			PÖTTINGER			OKRETAČI			PÖTTINGER		
ŠIFRA	NAZIV	KAT.BR.				ŠIFRA	NAZIV	KAT.BR.			
199060D	Opruga okretača Pöttinger D					197129	Čahura okretača Pöttinger				
199060L	Opruga okretača Pöttinger L					198390	Čahura ležajna Pöttinger				
192302	Opruga okretača Pöttinger D					199109	Osovinica ležaja okretača Pöttinger				
200268	Opruga okretača Pöttinger L					199173	Čahura okretača Pöttinger				
197181	Držac opruge okretača Pöttinger	0404366				199243	Poklopac PVC okretača Pöttinger				
201669	Držac opruge okretača Pöttinger					190059	Osigurač opruge okretača Pöttinger				
201670	Držac opruge okretača Pöttinger					197265	Čahura okretača Pöttinger				
196083	Držac opruge okretača Pöttinger					196558	Ležaj kotača Pöttinger KPL				
196082	Držac opruge okretača Pöttinger					192268	Sklopka okretača Pöttinger				
197825	Sklopka okretača Pöttinger					197128	Svornjak Pöttinger				
197826	Osovinica okretača Pöttinger										
192268	Sklopka okretača Pöttinger										

12



OKRETAČI SIP

ŠIFRA	NAZIV	KAT.BR.
197106	Opruga okretača Sip	
194434	Opruga okretača Sip	
196535	Opruga okretača Sip D (bijela)	
196534	Opruga okretača Sip L (crvena)	
196046	Opruga okretača Sip	
197332	Opruga okretača Sip	
195477	Opruga okretača Sip	
195258	Držač opruge okretača Sip	
190324	Držač opruge okretača Sip	
201548 201549	Osigurač opruge okretača Sip	
080056	Zupčanik stožasti Z15	
195328	Zupčanik tanjurasti Z36	

OKRETAČI SIP

ŠIFRA	NAZIV	KAT.BR.
195327	Zupčanik Z15	
195252	Osovina okretača Sip	

OKRETAČI STOLL

ŠIFRA	NAZIV	KAT.BR.
191338	Opruga okretača Stoll	
196159	Opruga okretača Stoll D (zeleno)	
201668	Opruga okretača Stoll L (bijela)	
201545	Opruga okretača Stoll D	401362
201546	Opruga okretača Stoll L	401363
201730	Opruga okretača Stoll	401364
196645	Držač opruge okretača Stoll	
201731	Držač opruge okretača Stoll	404278
201732	Držač opruge okretača Stoll	404279

12



Prostor za bilješke

12

PSC ferencak



**DIJELOVI ZA SAKUPLJAČE**

CLASS	160
DEUTZ-FAHR	160-161
FELLA	161
KRONE	161-162
KUHN	162
NIEMEYER	162-163
PÖTTINGER	163
SIP	163-164
STOLL - VICON	164





SAKUPLJAČI CLAAS

ŠIFRA	NAZIV	KAT.BR.	
199711	Opruga sakupljača Claas		
200124	Opruga sakupljača Claas	5259554830	
200324		401213	
200570	Opruga sakupljača Claas		
201342	Opruga sakupljača Claas	401201	

196083	Držač opruge sakupljača Claas		
--------	-------------------------------	--	--

199174	Ležajna čahura PVC sakupljača Claas		
--------	-------------------------------------	--	--

197265	Čahura Claas		
--------	--------------	--	--

SAKUPLJAČI DEUTZ - FAHR

ŠIFRA	NAZIV	KAT.BR.	
195507	Opruga sakupljača Deutz-Fahr		
197261	Opruga sakupljača Deutz-Fahr		
197182	Opruga sakupljača Deutz-Fahr		
198871	Opruga sakupljača Deutz-Fahr		

201483	Opruga sakupljača Deutz-Fahr	401232	
--------	------------------------------	--------	--

198293	Držač opruge sakupljača Deutz-Fahr		
--------	------------------------------------	--	--

199103	Držač opruge sakupljača Deutz-Fahr		
--------	------------------------------------	--	--

198900	Držač opruge sakupljača Deutz-Fahr		
--------	------------------------------------	--	--

199059	Osigurač opruge sakupljača Deutz-Fahr		
--------	---------------------------------------	--	--

196909	Kućište ležaja aluminijsko Deutz-Fahr		
--------	---------------------------------------	--	--

SAKUPLJAČI DEUTZ - FAHR

ŠIFRA	NAZIV	KAT.BR.	
199180	Opruga sakupljača Deutz-Fahr		

197885	Opruga sakupljača Deutz-Fahr		
--------	------------------------------	--	--



SAKUPLJAČI DEUTZ - FAHR

ŠIFRA	NAZIV	KAT.BR.	
196907	Polučahura PVC Deutz-Fahr		
196558	Ležaj kotača KPL Deutz-Fahr		
200408	Puškica s mazalicom Deutz-Fahr		
196115	Ležaj sa osovinom		

SAKUPLJAČI FELLA

ŠIFRA	NAZIV	KAT.BR.	
199391	Opruga sakupljača Fella		
196939	Opruga sakupljača Fella		
197109	Opruga sakupljača Fella		
196159	Opruga sakupljača Fella-Stoll D		
201668	Opruga sakupljača Fella-Stoll L	401340	
199051	Opruga sakupljača Fella		

SAKUPLJAČI FELLA

ŠIFRA	NAZIV	KAT.BR.	
199057	Držač opruge sakupljača Fella		
199176	Rolica s ležajem sakupljača Fella Za modele: TS250, 280, 285, 290, 295, 305, 310 TS 325, 330, 335, 415, 630, 631, 780		
199056	Rolica s ležajem sakupljača Fella Za modele: TS8, TS8D TS 250, 280, 285, 310, 325		
197878	Rolica sležajem Fella Za modele: TS8, TS8D TS 250, 280, 285, 310, 325		
199493	Krivulja sakupljača Fella		

SAKUPLJAČI KRONE

ŠIFRA	NAZIV	KAT.BR.	
196560	Opruga sakupljača Krone		
202955	Opruga sakupljača Krone D (unutarja)	401496	
202954	Opruga sakupljača Krone L (unutarja)	401497	

13



SAKUPLJAČI KRONE

ŠIFRA	NAZIV	KAT.BR.
201262	Opruga sakupljača Krone D (vanjska)	401498
201263	Opruga sakupljača Krone L (vanjska)	401499
201260	Opruga sakupljača Krone (unutarnja)	401488
201261	Opruga sakupljača Krone (unutarnja)	401489
201953	Opruga sakupljača Krone L (vanjska)	401493
199707	Držač opruge sakupljača Krone	

SAKUPLJAČI KUHN

ŠIFRA	NAZIV	KAT.BR.
199435	Opruga sakupljača Kuhn	
199546	Držač opruge sakupljača Kuhn	
192263	Držač opruge sakupljača Kuhn	
197180	Držač opruge sakupljača Kuhn	404288
198783	Držač opruge sakupljača Kuhn	451603

13

SAKUPLJAČI KUHN

ŠIFRA	NAZIV	KAT.BR.
192537	Opruga sakupljača Kuhn	
195798	Opruga sakupljača Kuhn	
193574	Opruga sakupljača Kuhn	
202124	Opruga sakupljača Kuhn	401495
199799	Opruga sakupljača Kuhn	401352

198391	Ručica sakupljača Kuhn	
202891	Nosač ruke sakupljača Kuhn	57759500

SAKUPLJAČI NIEMEYER

ŠIFRA	NAZIV	KAT.BR.
192764	Opruga sakupljača Niemeyer	
199048	Opruga sakupljača Niemeyer	



SAKUPLJAČI NIEMEYER

ŠIFRA NAZIV KAT.BR.

201484 Opruga sakupljača Niemeyer 401416



201487 Držač opruge sakupljača Niemeyer 404275



201840 Spojka sakupljača Niemeyer 015441



SAKUPLJAČI PÖTTINGER

ŠIFRA NAZIV KAT.BR.

191182 Ležaj krivulje sakupljača Pöttinger

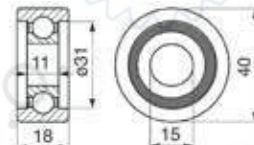

196083 Držač opruge sakupljača Pöttinger



201550 Osovina sakupljača Pöttinger

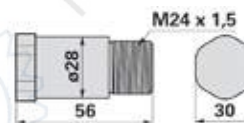

201551 Čahura sakupljača Pöttinger

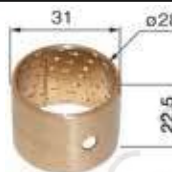

203520 Čahura sakupljača Pöttinger

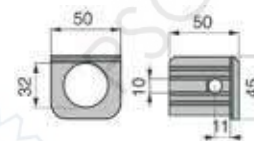

197265 Čahura sakupljača Pöttinger

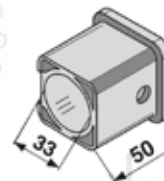

203010 Felga 3,5-6 KPL Pöttinger



SAKUPLJAČI PÖTTINGER

ŠIFRA NAZIV KAT.BR.

100313 Opruga sakupljača Pöttinger

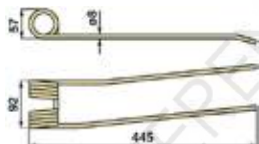

198292 Opruga sakupljača Pöttinger D



200231 Opruga sakupljača Pöttinger L

198239 Opruga sakupljača Pöttinger



199056 Rolica s ležajem i osovinom Pöttinger



197878 Rolica s ležajem Pöttinger

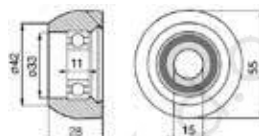

SAKUPLJAČI SIP

ŠIFRA NAZIV KAT.BR.

197949 Opruga sakupljača Sip
Za modele Star



195476 Opruga sakupljača Sip
Za modele Star





SAKUPLJAČI SIP

ŠIFRA	NAZIV	KAT.BR.	
080017	Opruga sakupljača Sip Za modele Favorit		
070017	Vilica varena Za modele Favorit		
080007	Vodilica Sip Za modele Favorit		
080012	Podložna pločica Za modele Favorit		
080010	Ležaj PVC Sip Za modele Favorit		
100146	Vijak M8x60		
100116	Matica		
080011	Podloška Za modele Favorit		
080029	Mehanizam okretni 200		
080028	Mehanizam okretni 220 Za modele Favorit		
192088	Ručica sakupljača Sip Za modele Star		
192072	Ležaj Za modele Star		
195250	Zupčanik stožasti Za modele Star		
197865	Zupčanik Z76 Za modele Star		

SAKUPLJAČI SLAM - STOLL - VICON

ŠIFRA	NAZIV	KAT.BR.	
197661	Opruga sakupljača SLAM		
196159	Opruga sakupljača STOLL		
201545	Opruga sakupljača Stoll D	401362	
201546	Opruga sakupljača Stoll L	401363	
197189	Rolica s ležajem sakupljača STOLL		
195507	Opruga sakupljača VICON		
198871	Opruga sakupljača VICON		
198900	Držač opruge sakupljača VICON		
199174	Ležajna čahura PVC sakupljača VICON		



Prostor za bilješke







Strana

DIJELOVI ZA PREŠE

CLASS	168-169
DEUTZ-FAHR / RASSPE	169-170
FORT	170
HESSTON	171
JOHN DEERE	171
KRONE	172
MASSEY FERGUSON	173
NEW HOLLAND	173
VICON	174
WELGER	174-176
OSTALI DIJELOVI ZA PREŠE	176

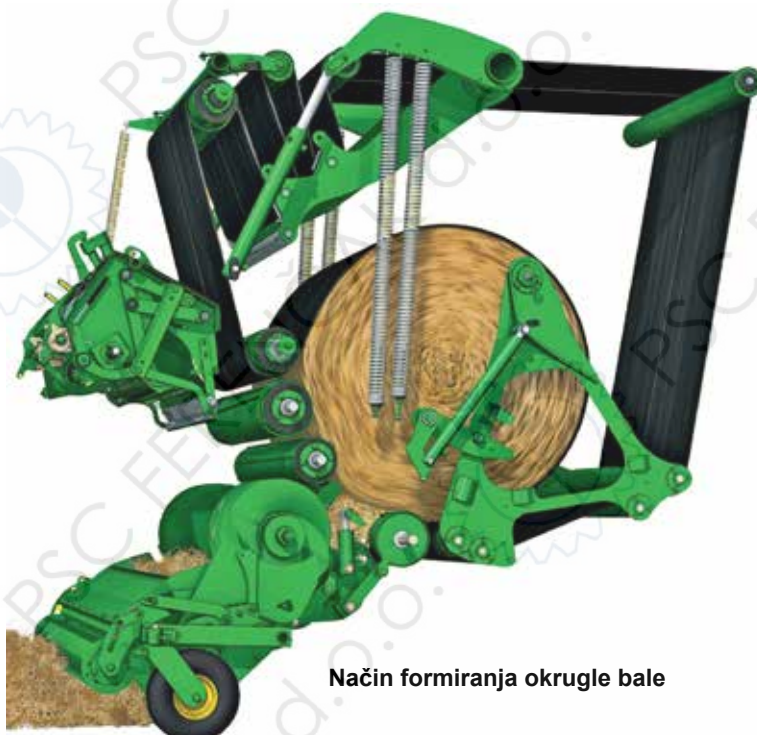
14

Način formiranja okrugle bale



PREŠE CLAAS



Pozicija na slici	Šifra	Naziv
1	198167	Stezač čvora vezača
2	198177	Dodavač vezaču
3	198178	Ručica vezača
4	198179	Uležište vezača
5	198180	Tijelo vezača
6	198181	Rog vezača
7	198182	Potpornik vezača
8	198183	Petljač vezača
9	198184	Jezičak vezača
10	198185	Stezna ploča vezača
11	198186	Osovinica vezača
12	198187	Kuka vezača
13	198188	Nožić vezača
14	198189	Zupčanik vezača mali
15	198190	Zupčanik vezača veliki
16	198191	Pritiskivač vezača
17	199027	Opruga povratna
18	199040	Svornjak petljača
19	201526	Opruga petljača

14

ŠIFRA	NAZIV	KAT.BR.	ŠIFRA	NAZIV	KAT.BR.
199029	Prsten spojke Claas	CL02-20	194147	Opruga pick up-a Claas	
202778	Zub uskočni Claas	CL02-22	080060	Opruga pick up-a Claas	
202779	Ribež-škruga Claas	CL02-34 810860	200571	Opruga pick up-a Claas	5259182390
202792	Ploča petljača	CL50 808274	190033	Opruga pick up-a Claas	807.297.0
			201552	Opruga pick up-a Claas	540143
199030	Prirubnica kuplunga Claas	CL02-35	201444	Opruga pick up-a Claas	540152
199028	Spojka kuplunga Claas	CL02-26	201443	Opruga pick up-a Claas	540150



PREŠE CLAAS

ŠIFRA	NAZIV	KAT.BR.	ŠIFRA	NAZIV	KAT.BR.
199038	Lim pick up-a Claas		201510	Ležaj klipa Claas Markant 50	B06-07
202579	Lim pick up-a Claas	8191641	198213	Igla preše Claas Markant 40	
203017	Lim pick up-a Claas	8602300	198214	Igla preše Claas Markant 50 i 51	

PREŠE DEUTZ-FAHR / RASPE



Pozicija na slici	Šifra	Naziv
1	191995	Poluga nož vezača
2	198165	Petljač vezača
3	191996	Rolna vezača
4	195633	Tijelo vezača
5	194836	Osovinica puža vezača
6	194139	Zupčanik vezača mali
7	100184	Puž vezača
8	192707	Zahvatnik špage vezača
9	191530	Nož vezača
10	192241	Tijelo zatvarača
11	192242	Zučanik vezača
12	192245	Držać špage vezača
13	192244	Ježičak vezača
14	192240	Čistač vezača
15	192239	Lisnata opruga vezača
16	192243	Zupčanik vezača veliki

14

ŠIFRA	NAZIV	KAT.BR.	ŠIFRA	NAZIV	KAT.BR.
193713	Opruga pick up-a Deutz-Fahr		200073	Opruga pick up-a Deutz-Fahr	
196992	Opruga pick up-a Deutz-Fahr		200404	Opruga pick up-a Deutz-Fahr	



PREŠE DEUTZ-FAHR / RASPE

ŠIFRA	NAZIV	KAT.BR.	ŠIFRA	NAZIV	KAT.BR.
100311	Lim pick up-a Deutz-Fahr		192259	Opruga dupla Deutz-Fahr	
196991	Lim pick up-a Deutz-Fahr		198216	Igla preše Deutz-Fahr HD400 HD440	
202777	Disk vezača Raspe		198217	Igla preše Deutz-Fahr HD360 HD400 HD440	
192958	Nož balirke Deutz-Fahr Za modele: RB3.56, 3.81, 4.81 MP 119, 121, 122, 124, 125, 155 RB3.20, 3.50, itd.				

14 PREŠE FORT

ŠIFRA	NAZIV	KAT.BR.	ŠIFRA	NAZIV	KAT.BR.
198400	Opruga pick up-a Fort		192304	Član lanca	
201265	Opruga pick up-a Fort	540167	192261	Spojnica lanca	
199429	Lanac balirke 6 članaka		190616	Distanca podložna letve Fort	
			192014	Lanac Fort 8,33 m	
			100310	Lanac Fort 6,4 m	



PREŠE HESSTON

ŠIFRA	NAZIV	KAT.BR.	ŠIFRA	NAZIV	KAT.BR.
197674	Opruga pick up-a Hesston		200864	Osovina s ležajem Hesston	700055366
192924	Opruga pick up-a Hesston				

PREŠE JOHN DEERE



Pozicija na slici	Šifra	Naziv
1	198192	Poluga noža vezača
2	198193	Lisnata opruga vezača
3	198194	Zupčanik veliki
4	198195	Zupčanik mali
5	198196	Zatvarač vezača
6	198197	Puž vezača
7	198198	Petljač vezača
8	198199	Osovinica puža
9	198200	Zahvatnik špage
10	198201	Jezičak vezača
11	198202	Osovinica poluge
12	198203	Tijelo vezača
13	198204	Čistač vezača

14

ŠIFRA	NAZIV	KAT.BR.	ŠIFRA	NAZIV	KAT.BR.
198290	Opruga pick up-a John Deere		198228	Igla preše gusnata John Deere Za modele: 214-214T	
198224	Opruga pick up-a John Deere		198218	Igla preše limena John Deere Za modele: 224, 332, 336, 342, 346	
200332	Opruga pick up-a John Deere		199034	Ribež škrge John Deere	
200253	Opruga pick up-a John Deere		202781	Disk vezača John Deere	
195484	Sigurnosni vijak John Deere		202780	Češalj zahvatnika špage John Deere	



PREŠE KRONE

ŠIFRA	NAZIV	KAT.BR.	ŠIFRA	NAZIV	KAT.BR.
197216	Opruga pick up-a Krone		100319	Držač opruge pick up-a Krone	
				Za modele: F125, F155, V150, V180, CF155, CV150, Big Pack	
194351	Opruga pick up-a Krone		100312	Držač opruge pick up-a Krone	
				Za modele: Round, Vario, Combi Pack, Comprima, Big Pack	
198888	Opruga pick up-a Krone		199111	Lim bubnja pick up-a Krone	
196564	Opruga pick up-a Krone	402149	201144	Lim bubnja pick up-a Krone	9382881
199290	Opruga pick up-a Krone	278522	198887	Lim bubnja pick up-a Krone	
200328	Opruga pick up-a Krone	402145	197401	Lim bubnja pick up-a Krone	
197267	Opruga pick up-a Krone		196086	Spojnica lanca Krone	
199350	Četkica centralnog podmazivanja Krone		196687	Lanac letve Krone	
197747	Senzor preše Krone		196087	Spojnica lanca za letvu Krone	
	Za modele: Combi Pack, Vario, Comprima, Big Pack				
201511	Letva komore Krone		196634	Nož preše Krone (original)	
	Za modele: Big Pack				
			192362	Nož preše Krone (zamjenski)	
			196602	Nož preše Krone	2763645

14



PREŠE MASSEY FERGUSON

ŠIFRA NAZIV KAT.BR.

080040 Opruga pick up-a
Massey Ferguson

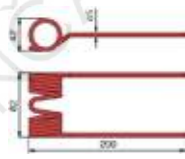

PREŠE NEW HOLLAND



Pozicija na slici	Šifra	Naziv
1	202782	Disk
2	202783	Petljač vezača
3	202784	Petljač vezača
4	202785	Zahvatnik
5	202786	Tijelo vezača
6	202787	Poluga noža
7	202788	Disk
8	202789	Zatvarač vezača
9	202790	Češalj vezača
10	202791	Zupčanik petljača

14

ŠIFRA NAZIV KAT.BR.

197984 Opruga Pick up-a
New Holland

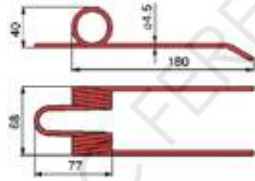

ŠIFRA NAZIV KAT.BR.

198243 Opruga Pick up-a
New Holland

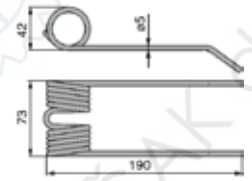

201439 Opruga Pick up-a
New Holland

202718 Opruga Pick up-a
New Holland

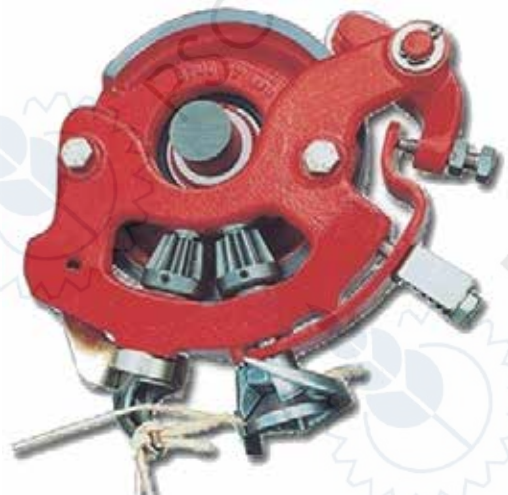
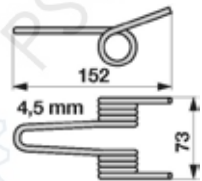



PREŠE VICON

ŠIFRA	NAZIV	KAT.BR.	ŠIFRA	NAZIV	KAT.BR.
200451	Opruga Pick up-a Vicon (original)		193714	Lim bubnja pick up-a Vicon	VF16514536
196992	Opruga Pick up-a Vicon				
190332	Opruga Pick up-a Vicon	540158	197856	Nož preše Vicon (original)	
			192958	Nož preše Vicon (zamjenski)	
193726	Lim bubnja pick up-a Vicon (original)		199050	Čahura PVC Vicon	
100311	Lim bubnja pick up-a Vicon (zamjenski)				
196991	Lim bubnja pick up-a Vicon		194646	Četkica centralnog podmazivanja Vicon	

14

PREŠE WELGER



pozicija na slici	Šifra	Naziv
1	140027	Tijelo vezača veće
2	198166	Zahvatnik špage
3	199022	Tijelo vezača manje
4	198167	Držać
5	198168	Jezičak vezača
6	198169	Nožić
7	198170	Zupčanik mali
8	198171	Pritiskivač
9	198172	Escentar
10	198173	Nožić
11	198174	Petljač



PREŠE WELGER

ŠIFRA	NAZIV	KAT.BR.	ŠIFRA	NAZIV	KAT.BR.
198612	Opruga Pick up-a Welger		199244	Opruga Pick up-a Welger	
199249	Opruga Pick up-a Welger		199355	Opruga Welger	
199258	Držač opruge pick up-a Welger		199035	Lim bubnja pick up-a Welger Za modele: AP12 AP51	
199036	Lim bubnja pick up-a Welger Za modele: AP42 AP52		199037	Lim bubnja pick up-a Welger Za modele: AP41 AP65	
198175	Disk vezača		199020	Zupčanik paljenja mali Welger	
199019	Lančanik paljenja Welger		199021	Konusni zupčanik paljenja Welger	
199023	Opruga Welger		199018	Ribež škrge Welger	
201507	Ležaj klipa Welger Za modele: AP42, 52, 53	1121.16.05.01 	201509	Ležaj klipa Welger Za modele: AP45	
201508	Ležaj klipa Welger Za modele: AP61, 63, 73, 730		198208	Igla preše Welger Za modele: AP41, 41R	



PREŠE WELGER

ŠIFRA	NAZIV	KAT.BR.	ŠIFRA	NAZIV	KAT.BR.
198209	Igla preše Welger Za modele: AP42, 500		198210	Igla preše Welger Za modele: AP45, 52	
198211	Igla preše Welger Za modele: AP48, 52, 53, 530		198226	Igla preše Welger Za modele: AP50, 51	
198215	Igla preše Welger Za modele: AP61, 75, 63, 630, 760, 200 Delta 2500		199322	Rola vrha igle preše Welger	

OSTALI DIJELOVI ZA PREŠE

ŠIFRA	NAZIV	KAT.BR.	ŠIFRA	NAZIV	KAT.BR.
196158	Spojnica remena preše U24CS 165 mm		196085	Čelična žica za spojnice	
201429	Spojnica remena preše U24CS 200 mm		195481	Brojač bala L	
199110	Spojnica remena za prešu s vijcima KPL		195482	Brojač bala D	
195482	Brojač bala D		201815	540402	
198225	Brojač bala mini		Na upit	Remen za roto bale glatki	
Na upit	Remen za roto bale romboidni				

14



Prostor za bilješke



PSC FERENČAK d.o.o.



DIJELOVI ZA KOMBAJNE



NOŽEVI, LEŽAJEVI I OPRUGE	180-184
REMENI KOMBAJNA CLAAS DOMINATOR 76	185
REMENI KOMBAJNA CLAAS LEXION 440 - 460	186
REMENI KOMBAJNA DEUTZ-FAHR M1300-M1322	187
REMENI KOMBAJNA DEUTZ-FAHR M3570-3578	188
REMENI KOMBAJNA DEUTZ-FAHR TOPLINER 4060-4065	189
REMENI KOMBAJNA JOHN DEERE 1085-1085H	190
REMENI KOMBAJNA JOHN DEERE 2054-2056-2058	191
OSTALI REMENI ZA KOMBAJNE	192-195













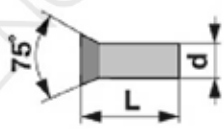

OSTALI DIJELOVI ZA KOMBAJNE

ŠIFRA	NAZIV	KAT.BR.	ŠIFRA	NAZIV	KAT.BR.
199153	Nož kose Schumacher fini		199152	Nož kose Schumacher grubi	
199139	Nož kose Deutz-Fahr		199138	Nož kose Massey Ferguson	
199136	Nož kose John Deere		201786	Nož kose Zmaj	
199134	Nož kose Case		199135	Nož kose Claas	
199137	Nož kose Laverda		199370	Nož kose Massey Ferguson	
201480	Nož kose Mörtl		198238	Nož kose Raspe	
195356	Kosa kombajna Claas 3,9 m vijak		203047	Kosa kombajna Claas 3,9 m nitna	
200757	Kosa kombajna Claas 4,5 m vijak		203408	Kosa kombajna Claas 4,5 m nitna	
201901	Kosa kombajna Claas 5,7 m s petom		201905	Kosa kombajna Claas produžni dio bez pete	
201902	Kosa kombajna Claas 7,5 m s petom		201906	Kosa kombajna Claas produžni dio bez pete	
200867	Kosa kombajna Deutz-Fahr 3 m		199158	Zakovica 6x16	
201904	Kosa kombajna Deutz-Fahr produžni dio s petom		199157	Zakovica 6x18	

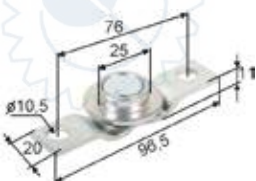
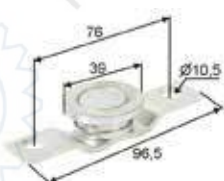
15

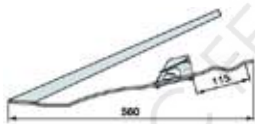



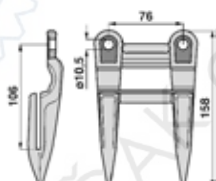
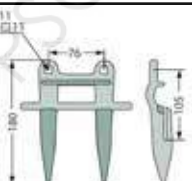
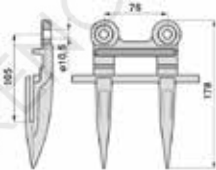
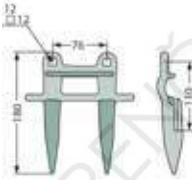
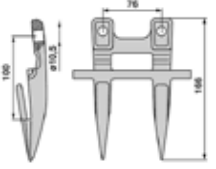
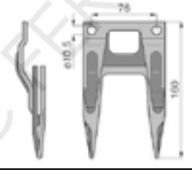
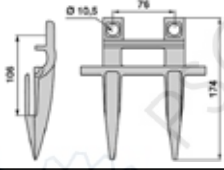
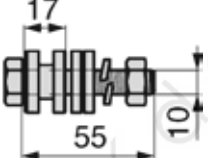
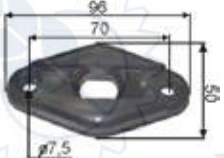





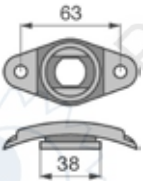

OSTALI DIJELOVI ZA KOMBAJNE

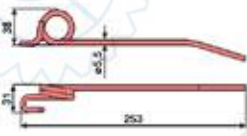
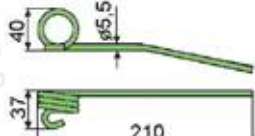
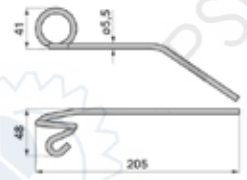
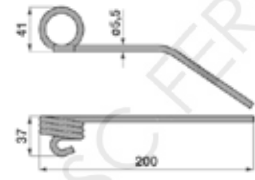
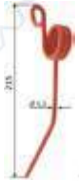
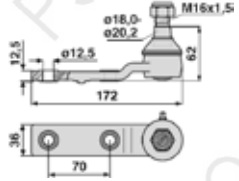
ŠIFRA	NAZIV	KAT.BR.	ŠIFRA	NAZIV	KAT.BR.
199156 203233 192843 199159 201100	Zakovica 5x16 Zakovica 6x18 Zakovica 6x25 Zakovica 6x30 Zakovica 6x35		199164	Vijak noža Schumacher M6x16	
199160 199163	Vijak noža M6x18 (nazubljeni, sigurnosni) Matica		199161	Vijak noža s maticom KPL M6x28	
199150	Rolica kose Schumacher		199151	Rolica kose Schumacher	
199148	Podizač klasova Claas		199147	Podizač klasova Deutz-Fahr, Fendt, John Deere, Schumacher	
203116	Podizač klasova Schumacher		199145	Dupli prst Deutz-Fahr John Deere	
199140	Dupli prst Deutz-Fahr		199143	Dupli prst John Deere	
199141	Dupli prst Claas 42838.01		199142	Dupli prst Claas 6762354 42837.14	
199144	Dupli prst Claas 42834.03		201772	Dupli prst Deutz-Fahr 42824.02	
203123	Dupli prst Schumacher 10701		200547	Dupli prst Clayson 504144	
199149	Držač Case		195390	Vodilica prsta Deutz-Fahr	

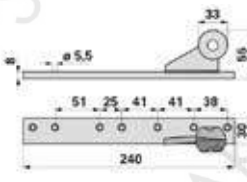
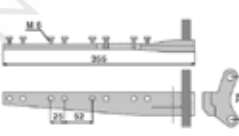
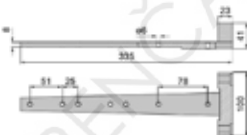

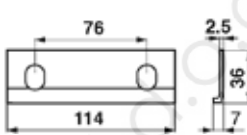
OSTALI DIJELOVI ZA KOMBAJNE

ŠIFRA	NAZIV	KAT.BR.	ŠIFRA	NAZIV	KAT.BR.
100089	Vodilica prsta New Holland		197585	Vodilica prsta John Deere	
					
200409	Vodilica prsta Claas	501326	200331	Vodilica prsta Deutz-Fahr	508324
					
198650	Opruga hedera		197190	Opruga hedera	
					
201675	Opruga hedera Claas	501309	201676	Opruga hedera Claas	501311
					
201677	Opruga hedera Claas	501349	199154	Peta kose Claas	
					
199155	Peta kose Claas		203045	Peta kose Claas	6667431
					
200759	Peta kose Deutz-Fahr	0623294.1	200569	Peta kose Deutz-Fahr	508163
					
199146	Peta kose Deutz-Fahr	42534	199550	Ležaj drveni Claas	
				106x80x60 Ø32	
199431	Ležaj drveni John Deere Ø35		199545	106x80x60 Ø35	
				106x80x60 Ø40	
197191	Pločica klizna Claas		199430	Ležaj drveni John Deere Ø38	
					
200480	Nosač noža kose Claas				

15

















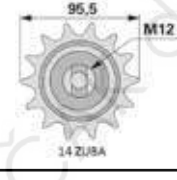

OSTALI DIJELOVI ZA KOMBAJNE

ŠIFRA	NAZIV	KAT.BR.	ŠIFRA	NAZIV	KAT.BR.
200481	Nosač noža kose Claas		203062	Prst puža hedera Claas	
199367	Prst puža hedera Claas		200474	Potiskivač kose Claas	
200475	Potiskivač kose Claas		200476	Potiskivač kose Claas	
203094	Selen Claas 12x30x28		203088	Selen Claas 25x50x50	
203093	14x35x32		203095	25x55x60	
203091	16x32x17		203089	36x70x65	
203092	18x34x42		203090	36x70x90	
199432	Čahura gumena			203085	
203063	Nosač prsta puža Claas		199333	Letva bubnja John Deere (par) 1280 mm	
199330	Letva bubnja New Holland (par) 1300 mm		199332	Letva bubnja Deutz-Fahr 1530 mm	
199331	Letva bubnja Deutz-Fahr (par) 1255 mm		200301	Letva bubnja Deutz-Fahr D 1095 mm	
202096	Letva bubnja Deutz-Fahr (par) 1255 mm		200302	Letva bubnja Deutz-Fahr L 1095 mm	
199329	Letva bubnja Claas (par)		199328	Letva bubnja Claas (par) 1305 mm	
199329	Letva bubnja Claas (par)		203050	Letva bubnja Claas D 1680 mm	
			203049	Letva bubnja Claas L 1680 mm	

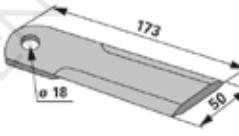

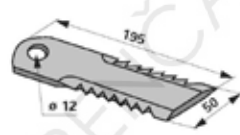
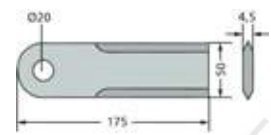
OSTALI DIJELOVI ZA KOMBAJNE

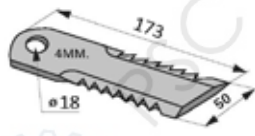
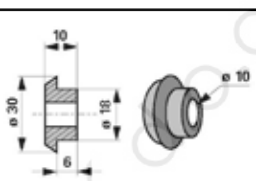
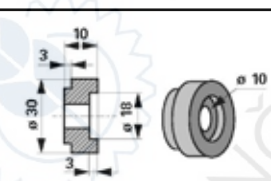
ŠIFRA	NAZIV	KAT.BR.	ŠIFRA	NAZIV	KAT.BR.
199326	Vijak letve John Deere M12		199532	Lančanič 8 zuba 38,4; Ø30 John Deere	
199327	Vijak letve John Deere M12		203076	Lančanič 7 zuba 38,4; Ø30 Claas	
203078	Lančanič 7 zuba 38,4; Ø26 Claas		203073	Lančanič 9 zuba 38,4; Ø45 Claas	
203077	Lančanič 7 zuba 38,4; Ø35 Claas		203075	Lančanič 9 zuba narečkani iznutra 38,4; Ø65/55 Claas	
203072	Lančanič 9 zuba 38,4; Ø50 Claas		203074	Lančanič 11 zuba narečkani iznutra 38,4; Claas	
203079	Lančanič 11 zuba 38,4; Ø26 Claas		203102	Napinjač lanca Z14 Claas KPL	
203104	Lančanič 24 zuba Claas		200413	Nož sječke Claas glatki 173x50x3	
203103	Napinjač lanca Z15 Claas KPL		201800	Nož sječke Claas nazubljeni 195x50x3	
201800	Nož sječke Claas nazubljeni 195x50x3		202222	Nož sječke Claas nazubljeni 175x50x4,5	
201805	Nož sječke Claas glatki 173x50x4		201804	Nož sječke Claas nazubljeni 175x50x4	
203084	Čahura noža Claas vanjska		203083	Čahura noža Claas unutarnja	

15



REMENI ZA KOMBAJNE

CLAAS DOMINATOR 76

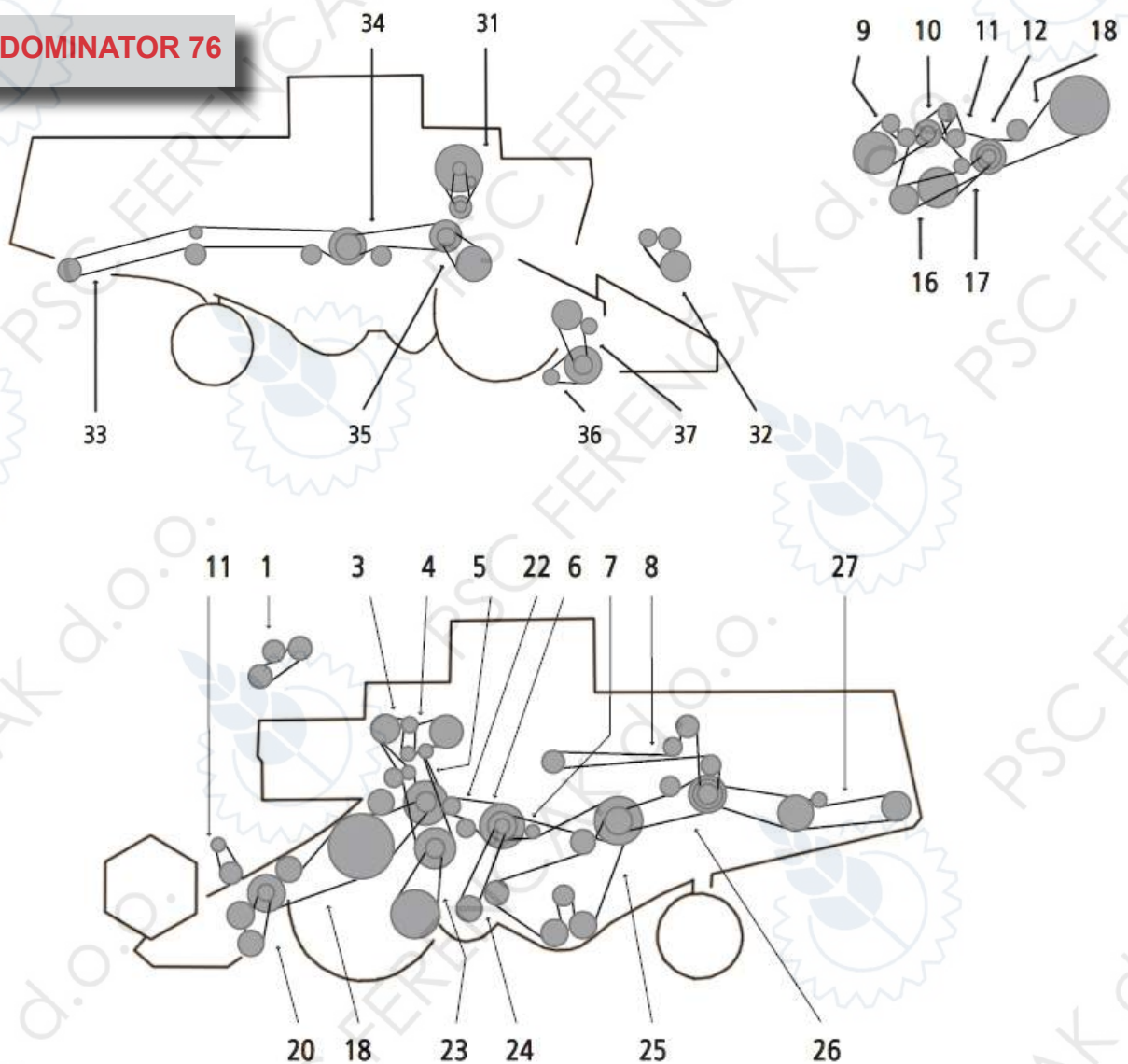

15

Pozicija na slici	Šifra	Kataloški broj	Pozicija na slici	Šifra	Kataloški broj
1	-	673625.0	18	-	303122.0
2	-	767057.1	20	-	629214.0
3	-	621903.0	21	-	673638.1
4	191134	673614.0	22	-	629436.0
5	193927	671012.0	23	193679	629737.0
6	199312	603337.0	24	193174	671209.0
6	-	672358.0	25	195371	603017.3
7	192321	672359.0	26	198476	506671.1
7	197861	603336.0	27	-	623427.1
8	197244	629732.1	31	-	783430.1
9	-	603284.0	32	199313	603247.0
10	-	056961.0	33	198258	061360.0
11	196104	670224.0	34	-	060306.2
12	-	056961.0	35	193678	603015.1
16	-	603283.0	36	-	629410.0
17	-	603048.0	37	-	680034.1



REMENI ZA KOMBAJNE

CLAAS LEXION 440 - 460

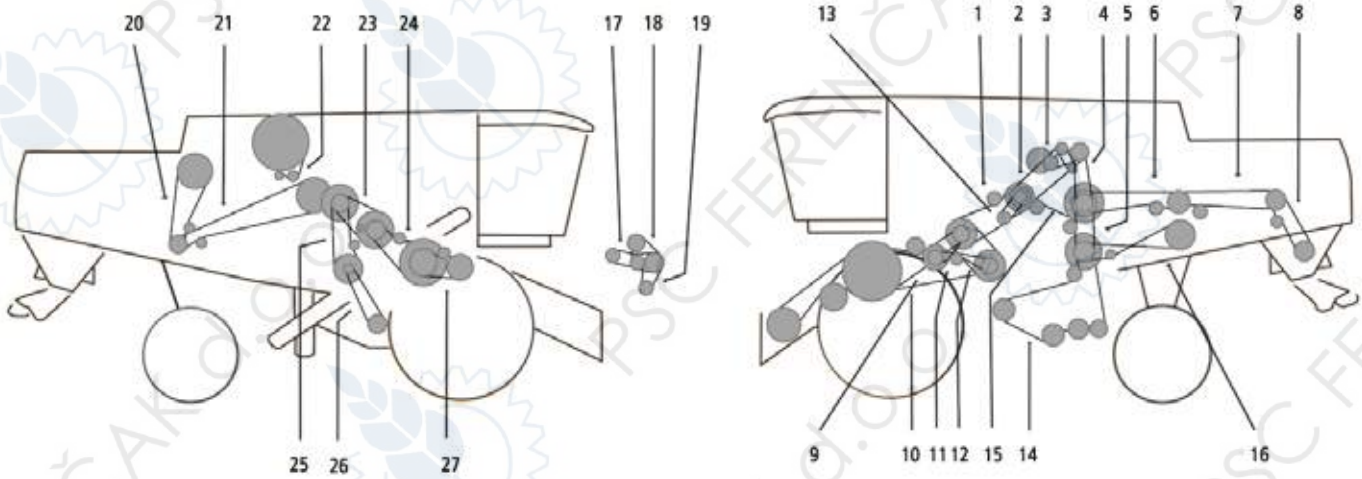

15

Pozicija na slici	Šifra	Kataloški broj
1	-	667255.0
2	199472	667453.0
3	-	667250.0
4	-	667958.2
5	-	667252.0
6	-	061700.1
7	-	061700.1
8	-	661093.0
9	-	667454.0
10	197476	667551.0
11	-	667249.0
12	-	667530.0
13	-	758791.0
14	-	667651.0

Pozicija na slici	Šifra	Kataloški broj
15	-	644209.0
16	-	667477.0
17	-	667560.1
18	-	667242.0
19	-	667456.0
20	-	667973.0
21	-	667974.0
22	193681	667561.1
23	-	667248.0
24	-	667458.0
25	-	742026.0
26	-	667457.0
27	199468	667251.0



REMENI ZA KOMBAJNE

DEUTZ - FAHR M1300 - M1322

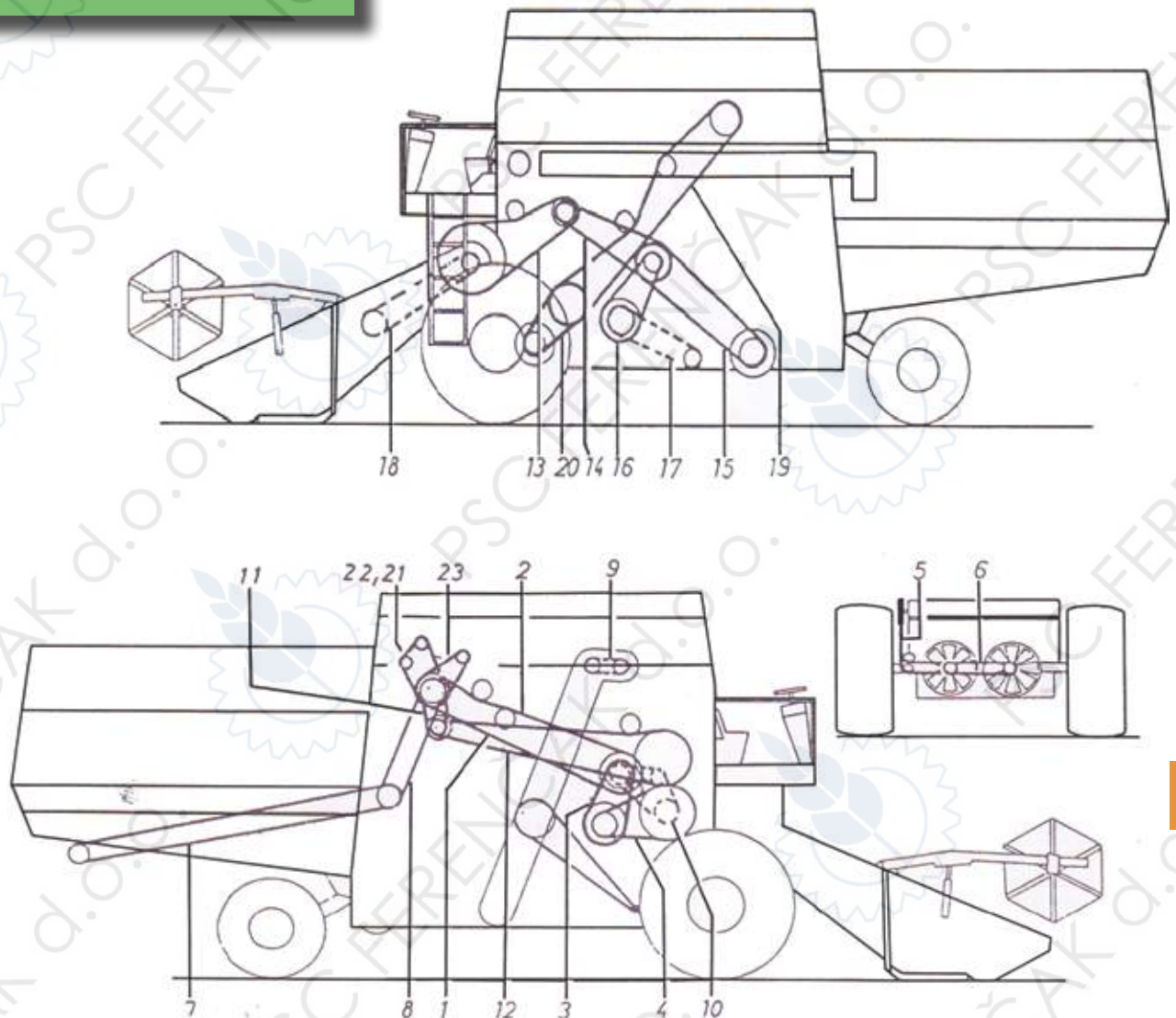

15

Pozicija na slici	Šifra	Kataloški broj
1	196172	0114 1591
2	190422	0621 5234
3	190423	0621 5221
3	190424	0621 5222
4	190425	0625 6381
4	190432	0625 6546
5	191360	0113 9241
6	190426	0621 0869
6	190444	0621 0890
7	-	0112 9970
7	197171	0114 1624
8	190438	0114 5475
11	190439	0621 1014
12	192326	0621 0853
12	198366	0621 5241
13	190431	0114 1608

Pozicija na slici	Šifra	Kataloški broj
13	-	0114 1941
14	190442	0625 6619
15	190428	0621 0917
16	190433	0625 6714
18	196623	0621 5206
19	190429	0625 5583
19	194909	0621 5244
20	190424	0621 5223
21	199475	0223 5532
21	197537	0118 0447
21	-	0223 5176
22	-	0223 5177
22	197537	0118 0447
23	198252	0223 5179
23	198253	0117 9566



REMENI ZA KOMBAJNE

DEUTZ - FAHR M3570 - M3578

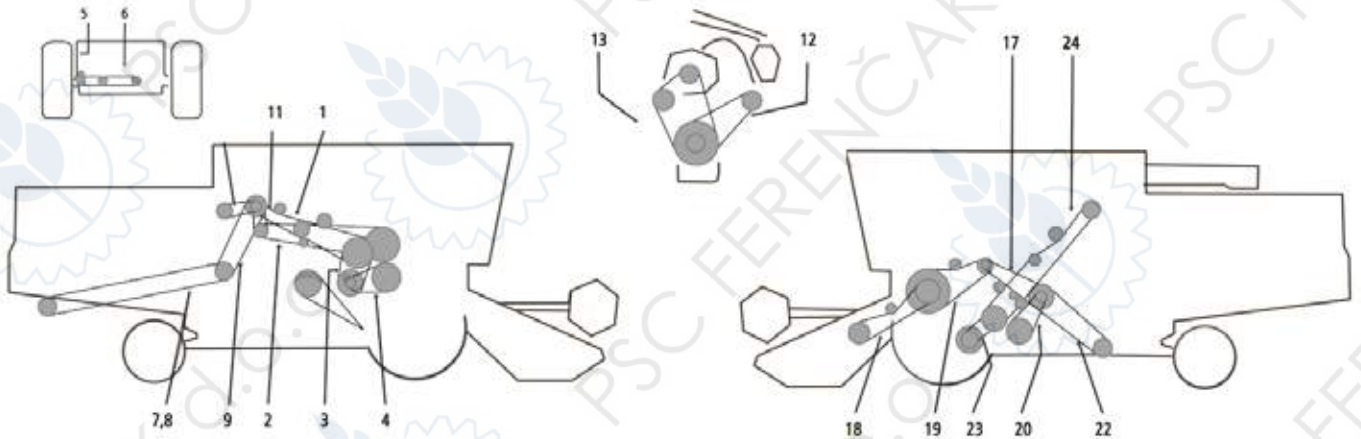

15

Pozicija na slici	Šifra	Kataloški broj
1	196172	0114 1591
2	197240	0114 1666
3	191424	0621 5222
4	190432	0625 6546
5	191360	0113 9241
6	190444	0621 0890
6	-	0114 5047
7,8	-	0114 1645
9	190438	0114 5475
11	190439	0621 1014
11	193165	0114 1613
12	198253	0117 9566
13	197537	0118 0447
15	-	0621 2866

Pozicija na slici	Šifra	Kataloški broj
17	190442	0625 6619
17	-	0114 1801
17	-	0113 9634
18	193166	0114 1595
18	193167	0114 1615
19	190431	0114 1608
20	190433	0625 6714
22	190428	0621 0917
23	190424	0621 5223
23	190424	0621 5223
23	-	0114 1971
23	-	0114 1971
24	194909	0621 5244



REMENI ZA KOMBAJNE

DEUTZ - FAHR TOPLINER 4060 - 4068

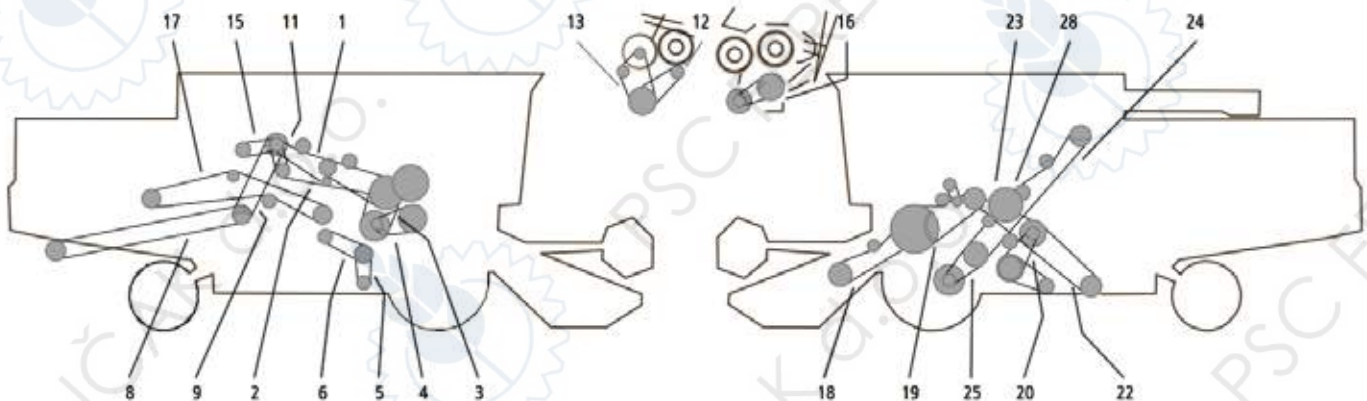

15

Pozicija na slici	Šifra	Kataloški broj
1	199309	0114 5050
2	-	0114 5055
3	196624	0114 5374
4	197173	0114 5049
5	194620	0114 5332
5	191354	0114 5369
6	194621	0114 5331
8	-	0114 5118
8	-	0114 5187
9	190438	0114 5475
9	-	0114 5479
11	193165	0114 1613
12	198253	0117 9566
13	197537	0118 0447
13	-	0223 5177
15	-	0621 2866
15	-	0114 5318

Pozicija na slici	Šifra	Kataloški broj
17	194619	0114 5051
17	-	0114 5054
17	198054	0114 5053
18	-	0114 3412
18	-	0114 3412
18	-	0114 5211
18	-	0114 3412
18	194615	0114 5025
19	190431	0114 1608
19	-	0114 5330
19	-	0114 1941
19	197539	0114 5329
20	194618	0114 3413
22	197538	0114 5052
23	194617	0114 3410
23	195426	0114 1944
24	-	0114 5102



REMENI ZA KOMBAJNE

JOHN DEERE 1085 - 1085H

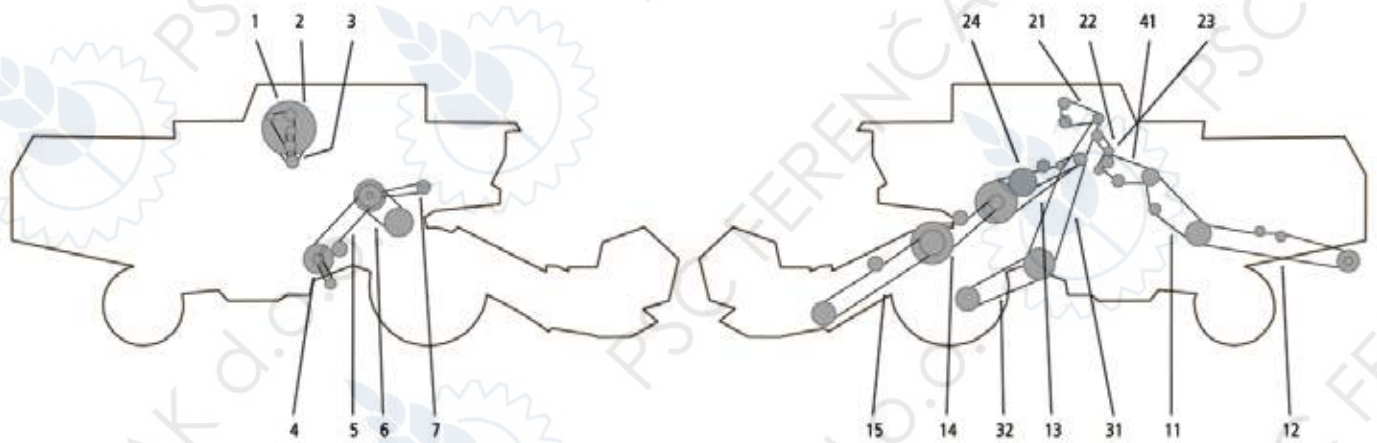

15

Pozicija na slici	Šifra	Kataloški broj
1	-	H79236
2	-	Z38703
3	-	Z38702
4	-	Z38704
5	-	Z38692
6	-	Z37473
7	-	Z34405
8	-	Z41178
9	-	Z45191
10	-	Z34786
11	-	H79235
12	-	Z45192
12	-	Z45367
13	-	Z45026

Pozicija na slici	Šifra	Kataloški broj
21	-	Z35965
22	-	Z33774
23	-	Z33790
23	191414	Z38697
24	-	Z43890
31	-	Z42756
32	-	Z42758
33	193675	Z34828
34	-	Z47912
41	199464	AZ22914
42	192324	Z34099
43	-	Z41563
51	-	Z43863



REMENI ZA KOMBAJNE

JOHN DEERE 2054 - 2056 - 2058

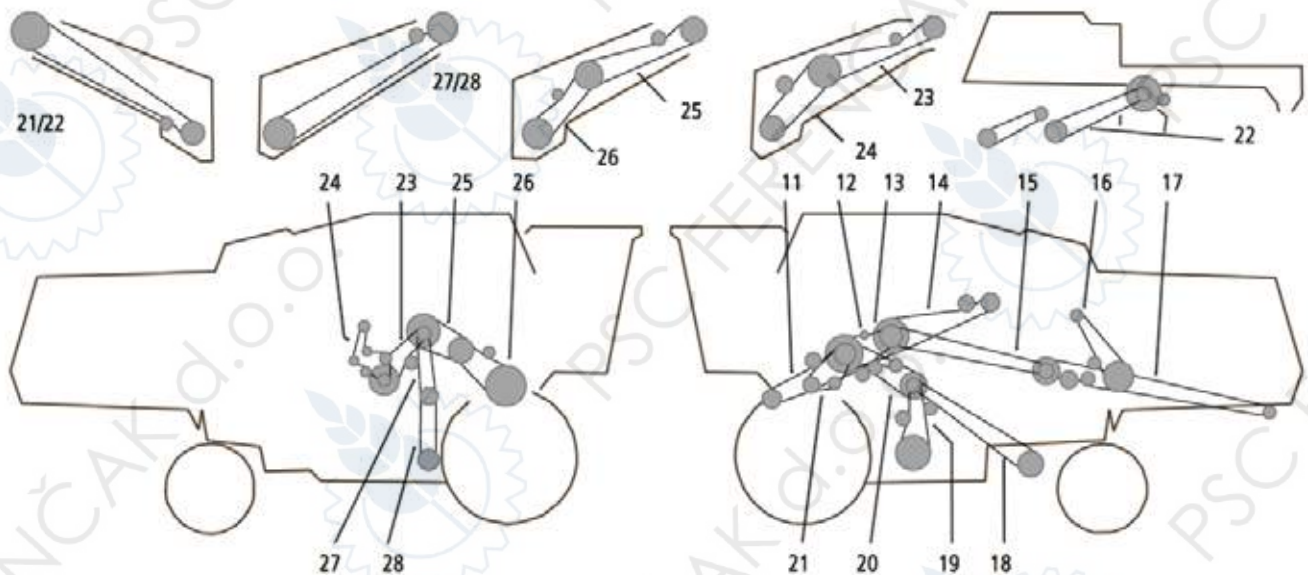

Pozicija na slici	Šifra	Kataloški broj
1	-	Z61151
2	-	Z58752
2	-	Z59419
3	-	Z59556
3	-	Z63005
4	-	Z59557
5	-	Z44936
6	-	Z61858
7	-	Z62110
8	-	Z62111
11	-	Z59344
12	-	Z59344
13	191711	Z64912
13	-	Z61150
13	-	Z52909
14	-	Z61857
15	-	Z59286
16	-	Z59114
17	-	Z59342
18	-	Z60135
19	-	Z59322

Pozicija na slici	Šifra	Kataloški broj
20	-	Z56959
21	-	Z56421
22	-	Z48212
23	-	Z61152
23	-	Z60931
24	-	Z61154
24	-	Z62211
25	-	Z61152
25	-	Z60931
25	-	Z54807
25	-	Z58751
26	-	Z61153
26	-	Z61827
26	-	Z62213
26	-	Z55459
27	-	Z61164
27	-	Z62551
27	-	Z54406
27	-	Z62214
28	-	Z60930
28	-	Z62552

**REMEI ZA KOMBAJNE TAGEX****CLAAS**

ŠIFRA	KATALOŠKI BROJ	ŠIFRA	KATALOŠKI BROJ	ŠIFRA	KATALOŠKI BROJ
193477	052393.0	197244	629732.1	201801	667458.0
201865	061214.0	193679	629737.0	201799	667530.1
199209	061353.1	197483	629763.0	191410	667545.0
198258	061360.0	199315	629769.1	197476	667551.1
201771	061361.0	197147	629836.0	193681	667561.1
193169	062294.0	199314	630144.0	201470	667651.0
202630	070310.1	196098	633030.2	197360	667881.0
198438	070952.2	203583	644016.1	197355	667891.1
198564	074771.2	196101	644141.1	201473	667958.3
197485	133528.0	192277	644177.0	192317	667983.0
197484	133630.0	201770	644209.0	196104	670224.1
203587	176475.0	196099	644403.1	193927	671012.1
197486	176543.1	198439	644405.2	201776	671013.1
201866	506023.0	198480	644866.0	200262	671015.0
198476	506671.2	197357	644884.0	195368	671083.0
197356	545689.0	197352	644885.0	193174	671209.0
193678	603015.1	197353	644890.0	191601	672351.0
195371	603017.3	201778	644892.0	192321	672359.1
193926	603122.0	197354	644942.0	197482	673614.0
199313	603247.1	197359	644966.0	191134	673614.1
196105	603290.0	203157	644017.0	200583	673638.1
200584	603317.0	203154	644966.0	194625	673639.1
197861	603336.1	195460	653060.0	195421	702536.1
199312	603337.0	192565	653063.0	194710	706087.0
195370	603341.0	198250	653121.0	195423	712419.1
193900	603380.1	201467	653380.1	195422	720695.0
195366	603427.0	192275	654534.0	197174	724247.1
196102	609762.0	191310	655408.0	198363	742206.0
203025	609822.0	196100	661031.1	202633	750193.2
193899	609823.0	196097	661114.0	194483	750294.0
194708	610830.0	196140	661239.1	191369	751112.0
192566	617309.0	196103	661245.0	191368	769202.1
201471	628888.0	193173	661345.0	195433	770214.0
197358	628978.0	200758	661378.1	192668	772660.0
195389	629000.1	203751	661451.0	191362	773313.0
198440	629001.0	200823	661458.0	194484	775698.0
195388	629035.0	203169	661092.1	191361	778561.0
192289	629133.0	201469	667248.0	200261	785168.2
200471	629410.0	201468	667250.0	197857	785173.0
203144	629436.0	199468	667251.1	192127	785174.1
200892	629441.0	199472	667453.0	200472	785176.0
199567	629510.0	201777	667457.0	191412	790461.0



REMENI ZA KOMBAJNE TAGEX

DEUTZ - FAHR

ŠIFRA	KATALOŠKI BROJ	ŠIFRA	KATALOŠKI BROJ	ŠIFRA	KATALOŠKI BROJ
199471	0113 6747	196624	0114 5374	193481	0621 5209
200470	0113 9204	190438	0114 5475	191308	0621 5213
200660	0113 9209	200586	0114 5479	192564	0621 5214
202908	0113 9227	199205	0114 5504	192278	0621 5215
197479	0113 9229	201774	0114 5884	198257	0621 5216
191360	0113 9241	200582	0114 6033	190416	0621 5217
190434	0113 9242	197185	0117 5244	192208	0621 5220
195387	0113 9242b	198253	0117 9566	190423	0621 5221
198477	0113 9260	197537	0118 0447	190424	0621 5222/5223
200466	0113 9634	198252	0223 5179	190427	0621 5233
197859	0114 1510	197477	0223 5180	190422	0621 5234
202280	0114 1530	198251	0223 5245	192126	0621 5235
196172	0114 1591	199475	0223 5532	190413	0621 5236
193166	0114 1595	192207	0223 5713	190414	0621 5237
190431	0114 1608	192326	0621 0853	192568	0621 5238
193165	0114 1613	190426	0621 0869	193114	0621 5239
193167	0114 1615	190444	0621 0890	193674	0621 5240
199470	0114 1623	197478	0621 0916	198366	0621 5241
197171	0114 1624	190428	0621 0917	190440	0621 5242
193113	0114 1637	200822	0621 0919	198059	0621 5243
197240	0114 1666	192560	0621 0922	194909	0621 5244
197186	0114 1788	196587	0621 0923	196106	0621 5245
202907	0114 1789	194626	0621 0989	190421	0621 5248
195427	0114 1816	190418	0621 0991	190443	0621 5249
197187	0114 1840	200468	0621 0993	190420	0621 5250
195425	0114 1909	193680	0621 0997	193671	0621 5253
200458	0114 1912	200463	0621 1001	193672	0621 5255
195426	0114 1944	200462	0621 1003	194709	0621 5257
200467	0114 1971	200464	0621 1006	191367	0621 5258
194617	0114 3410	190439	0621 1014	190441	0621 5259
201867	0114 3412	193119	0621 1026	197978	0621 5261
194618	0114 3413	192667	0621 1031	196171	0621 5262
194615	0114 5025	194706	0621 1053	193172	0623 4476
194622	0114 5026	190430	0621 1852	193099	0624 0268
197173	0114 5049	199476	0621 2833	193117	0624 1147
199309	0114 5050	201781	0621 2835	193101	0624 1305
194619	0114 5051	200465	0621 2866	190429	0625 5583
197538	0114 5052	197860	0621 2870	190425	0625 6381
198054	0114 5053	190417	0621 2919	190432	0625 6546
195224	0114 5056	190419	0621 2925	190442	0625 6619
199568	0114 5188	193118	0621 2933	190433	0625 6714
197858	0114 5203	190415	0621 5197	190437	0625 7897
202189	0114 5224	193120	0621 5199	198364	0625 7898
202684	0114 5261	192563	0621 5202	198254	0628 5949
197539	0114 5329	192559	0621 5203	193116	0652 8420
194621	0114 5331	195424	0621 5204	201869	0658 0049
194620	0114 5332	191309	0621 5205	196622	0658 0119
191354	0114 5369	196623	0621 5206		

**REMI ZA KOMBAJNE TAGEX****JOHN DEERE**

ŠIFRA	KATALOŠKI BROJ	ŠIFRA	KATALOŠKI BROJ	ŠIFRA	KATALOŠKI BROJ
198056	AE48912	197362	H164368	192324	Z34099
197364	AH158880	197365	H176765	194616	Z34121
191133	AZ37807	197366	H176766	193675	Z34828
203027	AZ51312	201796	H177177	197241	Z36120
199464	AZ22914/AZ40077	191711	H221732	198058	Z36376
197807	E65863	197349	L114468	192323	Z38186
201795	H139963	197350	L115661	191414	Z38697
201794	H141166	199316	Z20460	193102	Z39313
201785	H152146	193100	Z20823	193676	Z45482
201870	H156863	201773	Z21403	197175	Z49765
197361	H161945	198248	Z21501		
197363	H162310	193277	Z31191		

MASSEY FERGUSON**MENGELE**

ŠIFRA	KATALOŠKI BROJ
191537	401109M1
201472	782835M1
191417	783539M1
191418	784796M1
191357	789930M1
191356	789967M1
193481	226981M1
194624	1616714M1
194623	1616715M1
191355	1720255M1
191416	795514M1
200663	834174M1
191538	905921M1

ŠIFRA	KATALOŠKI BROJ
201868	04-109135
198437	04-113516
191604	04-113598
203582	04-119434
191601	04-122838
202076	04-133180
203586	98-027803
197086	98-039673
197087	98-039776
197088	98-039777
197089	98-039778
198367	98-039783
194304	98-045896
194705	99-060663

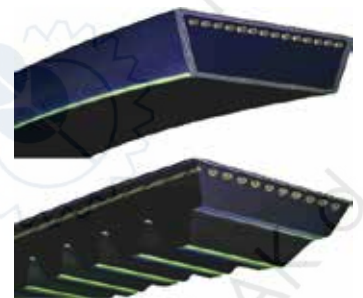

ŠIFRA	KATALOŠKI BROJ
191364	80230079
192567	80246978
197242	80336784
191600	80356025
197808	80367659
197475	80378989
197474	80387469
195367	80391650
196107	80383326

ŠIFRA	KATALOŠKI BROJ
197473	80395955
197243	80396750
197472	80397297
191602	80411543
191117	80420606
198565	80446969
192272	80825013
198259	80851792





REMEI ZA KOMBAJNE

CLAAS

ŠIFRA	KATALOŠKI BROJ
203156	506671.2
203164	603015.1
203150	603017.3
203168	609823.0
203167	629000.1
203165	629279.0
203171	629441.0
203155	629836.0
203157	644017.0
203154	644966.0
203169	661092.1
203158	603336.0
203152	603337.0
203151	603247.1
203166	671012.1
203170	984885.0

DEUTZ - FAHR

ŠIFRA	KATALOŠKI BROJ
203146	0113 9241
203161	0113 9242
203162	0114 1666
203148	0114 1608
203732	0114 5479
203147	0114 1591
203163	0114 1941

JOHN DEERE

ŠIFRA	KATALOŠKI BROJ
203160	AE48912
203729	Z64912

MASSEY FERGUSON

ŠIFRA	KATALOŠKI BROJ
203733	340433474
203731	344311322

MENGELE

ŠIFRA	KATALOŠKI BROJ
203730	98-039673

NEW HOLLAND

ŠIFRA	KATALOŠKI BROJ
203825	80356024
203121	84061615

Prostor za bilješke





**Sav asortiman remena
možete pronaći i kupiti u
našim
trgovinama ili na našoj web
stranici
www.psc-ferencak.hr**



REMENI I GUSJENICE

KLINASTI REMENI SPA, SPB, SPC 198

**KLINASTI REMENI NAZUBLJENI
XPA, XPB, XPZ 199**

KLINASTI REMENI 10/Z, 13/A 200

KLINASTI REMEN 17/B 201

KLINASTI REMEN 22/B 202

GUMENE GUSJENICE 203

Upute za narudžbu 204

Profili remena





KLINASTI REMENI - glatki (oznaka S)

profil SPA - glatki



Šifra	Model	Unutarnja "Li"	Vanjska "La"
192129	SPA 2500	-	-
202898	SPA 2682	-	-
196622	SPA 2832	-	-
201869	SPA 2882	-	-
191411	SPA 2932	-	-
198255	SPA 3000	-	-
200459	SPA 3082	-	-
199476	SPA 3182	-	-
200661	SPA 3382	-	-

profil SPB - glatki

Šifra	Model	Unutarnja "Li"	Vanjska "La"
195428	SPB 1250	-	-
194627	SPB 1250	-	-
203550	SPB 1500	-	-
192487	SPB 1800	-	-
191366	SPB 2120	-	-
198362	SPB 2240	-	-
192131	SPB 2800	-	-
192130	SPB 2840	-	-
201781	SPB 3250	-	-
201971	SPB 3550	-	-
195387	SPB 3695	-	-
192569	SPB 3750	-	-

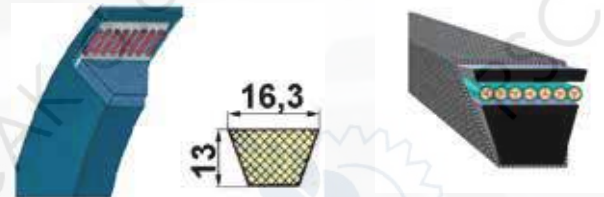

profil SPC - glatki



Šifra	Model	Unutarnja "Li"	Vanjska "La"
199467	SPC 2000	-	-
198368	SPC 2120	-	-
192476	SPC 2186	-	-
200660	SPC 350	-	-
193118	SPC 4100	-	-
199470	SPC 4500	-	-

profil SPZ - glatki

Šifra	Model	Unutarnja "Li"	Vanjska "La"
195385	SPZ	9,5x912	925
195382	SPZ	9,5x1012	1025
195386	SPZ	9,5x1087	1100
193452	SPZ	9,5x1537	-
201797	SPZ	9,5x1812	-
192133	SPZ	9,5x2650	-

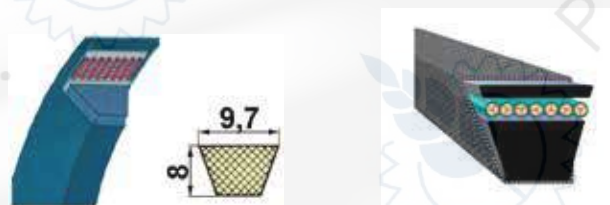



KLINASTI REMENI - nazubljeni (oznaka X)

profil XPA

Šifra	Model	Unutarnja "Li"	Vanjska "La"
196097	XPA 1157	-	-
200461	XPA 1832	-	-
201465	XPA 2160	-	-

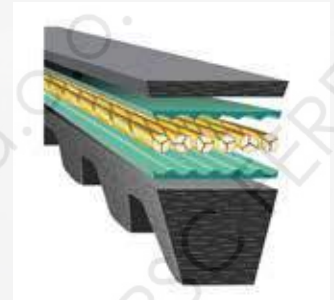
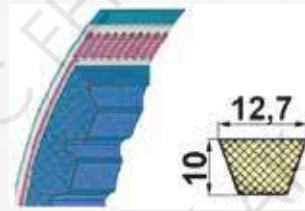

profil XPB - nazubljeni

Šifra	Model	Unutarnja "Li"	Vanjska "La"
190473	XPB 1250	-	-
199206	XPB 1320	-	-
203143	XPB 1400	-	-
199311	XPB 1450	-	-
203023	XPB 1500	-	-
202896	XPB 1550	-	-
202895	XPB 1600	-	-
200259	XPB 1650	-	-
200260	XPB 1800	-	-
199461	XPB 2650	-	-
199204	XPB 3000	-	-
200665	XPB 3550	-	-

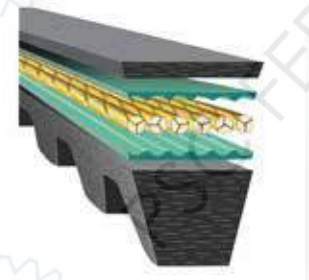
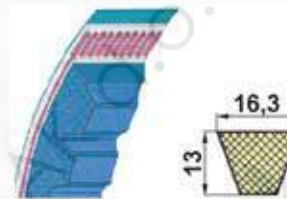

16

profil XPZ - nazubljeni

Šifra	Model	Unutarnja "Li"	Vanjska "La"
195435	XPZ 750	-	-
195384	XPZ 812	-	-
200662	XPZ 862	-	-
196096	XPZ 1010	-	-
201784	XPZ 1037	-	-
198253	XPZ 1110	-	-
198252	XPZ 1125	-	-
198563	XPZ 1180	-	-
202906	XPZ 1262	-	-
199475	XPZ 1320	-	-
195383	XPZ 1437	-	-
195676	XPZ 1512	-	-
195677	XPZ 1600	-	-
195678	XPZ 1637	-	-

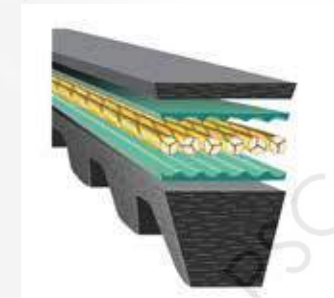
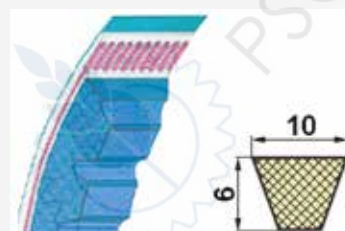

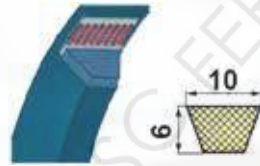
**KLINASTI REMENI****profil 10/Z**

Šifra	Naziv	Unutarnja "Li"	Vanjska "La"	("")
192132	10x	450	472	Z18
198566	10x	1000	1020	Z39,5
198567	10x	1096	1120	Z43
199207	10x	1168	1190	Z46
198568	10x	1200	1220	Z47
198569	10x	1250	1270	Z49
198570	10x	1300	1320	Z51

Šifra	Naziv	Unutarnja "Li"	Vanjska "La"	("")
193115	10x	1320	1340	Z52
197480	10x	1370	1390	Z54
198571	10x	1400	1420	Z55
198584	10x	1550	1570	Z61
199310	10x	1750	1770	Z69
197477	10x	-	1150	Z44
197185	10x	1180	-	Z45

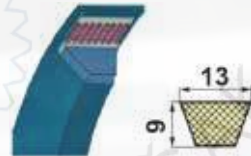
profil 13/A

Šifra	Naziv	Unutarnja "Li"	Vanjska "La"	("")
195840	13x	850	880	A33,5
198572	13x	900	930	A35,5
195379	13x	940	970	A37
198573	13x	965	995	A38
198574	13x	990	1020	A39
195836	13x	1055	1085	A41,5
195837	13x	1092	1120	A43
198575	13x	1105	1143	A43,5
195838	13x	1120	1150	A44
195839	13x	1143	1180	A45
199202	13x	1194	1224	A47
198576	13x	1245	1275	A49
190624	13x	1270	-	A50
195372	13x	1295	1325	A51
195842	13x	1350	1380	A53
195373	13x	1375	1410	A54
195374	13x	1422	1460	A56
193477	13x	1475	1510	A58
195375	13x	1500	1530	A59
198578	13x	1550	1580	A61
198579	13x	1600	1630	A63
190426	13x	1625	1660	A64
195376	13x	1700	1730	A67

Šifra	Naziv	Unutarnja "Li"	Vanjska "La"	("")
195377	13x	2100	2140	A83
195378	13x	2160	2190	A85
199208	13x	2500	2530	A98
195380	13x	975	1000	A38,5
200812	13x	1041	1071	A41
201464	13x	1067	1097	A42
197479	13x	-	1175	-
195841	13x	1250	1280	A49
197485	13x	1290	-	-
198577	13x	1295	1325	A51
201466	13x	1320	1350	A52
195413	13x	1625	-	-
192480	13x	2110	-	-
202897	13x	2184	2214	A86
201783	13x	2388	2420	A94
191312	13x			
191714	13x	2600	-	-
193173	13x	2840	-	-
193681	13x	3096	3146	
197245	13x	3150	-	-
197863	13x	3400	-	-
193479	13x	3850	-	-



KLINASTI REMENI

profil 17/B

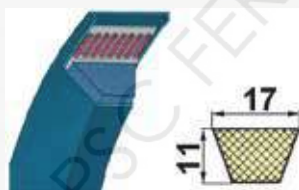

Šifra	Naziv	Unutarnja "Li"	Vanjska "La"	(")
202682	17x	838	878	B33
201775	17x	889	929	B35
196108	17x	901	941	B35,5
195843	17x			
198580	17x	925	965	
195844	17x	940	980	B37
195845	17x	956	1000	B37,5
195846	17x	965	1010	B38
198581	17x	976	1018	
195847	17x	1000	1040	B39
195848	17x	1060	1110	B42
195849	17x	1101	1141	B43
195850	17x	1120	1160	B44
195851	17x	1143	1183	B45
199203	17x	1194	1234	B47
190451	17x	1300	-	-
198562	17x	1300	1340	-
191599	17x	1320	1360	B52
198582	17x	1346	1386	
196098	17x	1350	-	-
203588	17x	1360	1400	-
203585	17x	1400	1440	B55
195852	17x	1450	1490	B57
198583	17x	1500	-	-
195370	17x	1520	-	-
198475	17x	1550	1590	B61
198474	17x	1600	1640	B63
199473	17x	1625	1665	B64
190444	17x	1650	-	-
201973	17x	1650	1690	B65
200460	17x	1700	1740	B67
194617	17x	1715	-	-
198473	17x	1450	1790	B69
190625	17x	1800	-	-
194483	17x	1829	-	-

Šifra	Naziv	Unutarnja "Li"	Vanjska "La"	(")
195381	17x	1900	1950	B75
197186	17x	1920	-	-
190433	17x	1980	-	-
194712	17x	2060	2100	B81
192482	17x	2110	-	-
194618	17x	2110	-	-
193478	17x	2160	-	-
199474	17x	2288	2326	B92
191365	17x	2360	-	-
190432	17x	2438	-	-
190425	17x	2515	-	-
197173	17x	2650	-	-
190442	17x	2835	-	-
191313	17x	2840	-	-
194619	17x	2930	-	-
192483	17x	3100	-	-
190428	17x	3150	-	-
200822	17x	3250	-	-
197538	17x	3290	-	-
191360	17x	-	3425	-
197187	17x	3450	-	-
191359	17x	3450	-	-
192560	17x	3550	-	-
196587	17x	3600	-	-
194710	17x	3625	-	-
190434	17x	-	3675	-
191362	17x	4370	-	-
192672	17x	4394	4430	B173
190430	17x	4750	-	-
192326	17x	4800	-	-
197244	17x	5290	-	-
202907	17x	6300	-	-
198054	17x	6630	-	-
202280	17x	7000	7040	-

**KLINASTI REMENI****profil 22/B**

Šifra	Naziv	Unutarnja "Li"	Vanjska "La"	("")
204693	22x	1350	1408	C53
192273	22x	1375	-	-
204700	22x	1400	1458	C55
197172	22x	1450	1510	C57
203584	22x	1500	1558	-
200471	22x	1600	-	-
192338	22x	1800	1860	C71
192337	22x	1850	1910	C73
193680	22x	2050	-	-
192322	22x	2100	-	-
193171	22x	2105	-	-
191358	22x	-	2120	-
192486	22x	2175	-	-
195459	22x	2175	-	SET
192498	22x	2415	-	-
204704	22x	2540	-	-
194626	22x	2705	-	-
202901	22x	2750	2808	-
197858	22x	2790	-	-
190418	22x	2800	-	-
190419	22x	-	2800	-
199312	22x	2825	-	-
201776	22x	2960	-	-
192343	22x	2968	-	-
199205	22x	3040	-	-
201774	22x	3040	-	-
198364	22x	3096	-	-
190438	22x	3100	-	-
201770	22x	3220	-	-
204699	22x	3220	-	-
202010	22x	3240	3330	-
201664	22x	3250	3310	-

Šifra	Naziv	Unutarnja "Li"	Vanjska "La"	("")
191363	22x	3320	-	-
190626	22x	3327	-	-
198057	22x	3505	3565	-
200686	22x	3524	-	-
195422	22x	3660	-	-
191418	22x	3660	-	-
193166	22x	3700	-	-
197147	22x	3880	-	-
200463	22x	3950	-	-
204595	22x	3995	-	-
192479	22x	4000	-	-
196105	22x	4100	-	-
200462	22x	4100	-	-
191419	22x	4150	-	-
202900	22x	4250	-	-
201867	22x	4262	-	-
200464	22x	4440	-	-
192318	22x	5020	-	-
190429	22x	5100	-	-
195371	22x	5700	-	-
199465	22x	5715	5773	-
199466	22x	5791	5849	-
197174	22x	6230	-	-
200758	22x	6390	-	-
190437	22x	6640	-	2kom
201771	22x	7200	-	-
191410	22x	7330	-	-
197476	22x	7760	-	-
201865	22x	8040	-	-
201794	22x	8052	-	-
199209	22x	8215	-	-
198258	22x	8220	-	-



GUMENE GUSJENICE



Za modele:

AIRMANN, ATLAS, BOBCAT, CATERPILLAR, CHIKUSUI, DAEWOO, EUROCOMACH, EUROTRAC, FIAT, HANIX, HINOWA, HITACHI, IHI, JCB, KOBLECO, KOMATSU, KUBOTA, LIBRA, MACMOTER, MELROE NEUSON, NISSAN, O&K, PEL JOB, SCHAEFF, TAKEUCHI, YANMAR, ZEPPELIN I DR.

Šifra	Dimenzije (širina x korak x broj članaka)
193896	200x42x75
197338	200x39x72
196638	230x30x96
193484	230x33x96
195441	230x36x96
196994	230x47x72
193377	250x45x72
193747	250x47x72
196923	250x52,5x76
193958	300x52,5x74
194013	300x52,5x78
193928	300x52,5x84
193895	300x52,5x72
193970	300x55,5x82
200529	300x55x78
196919	300x52,5x80
196920	300x52,5x84

Šifra	Dimenzije (širina x korak x broj članaka)
196997	300x52,5x86
195014	320x38x100
193897	320x40x100
195019	320x43x100
193948	320x54x72
192558	320x54x78
196921	400x72,5x72
196922	400x72,5x74
197710	400x75,5x74
197711	450x83,5x74
201272	450x71x86
192186	230x34x72
192120	230x31x96
192119	KH41
196893	400x72,5x74
192666	230x43x72



GUMENE GUSJENICE

Za narudžbu ili upite o specijaliziranim dijelovima pripremite podatke označene na slikama:

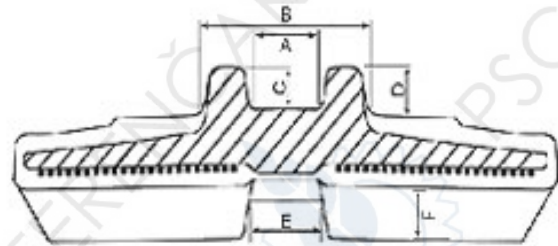
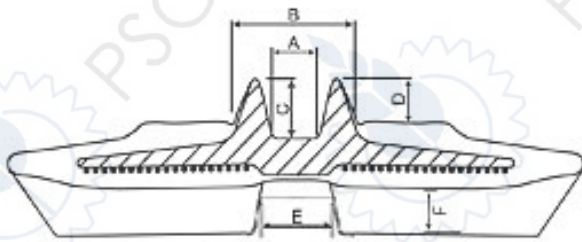

16

A _____

B _____

C _____

D _____

E _____

F _____

Korak _____

Proizvođač _____

Tip _____

Količina _____

Slika _____

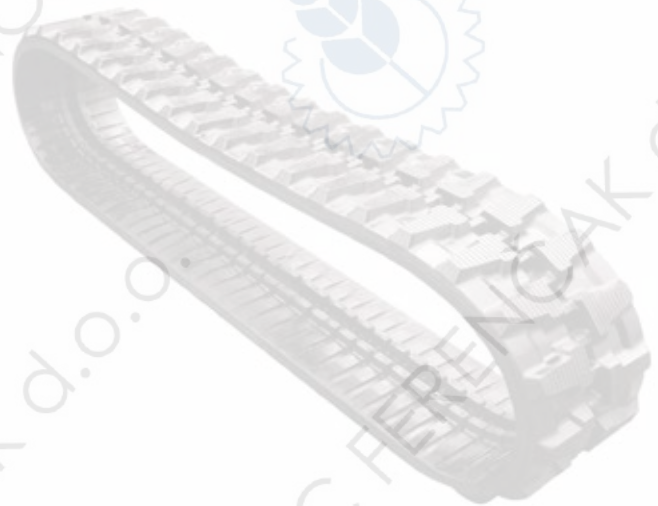



Prostor za bilješke

A large grid area for notes, overlaid with a large, faint watermark of the PSC FERENČAK logo and the text "PSC FERENČAK d.o.o." repeated diagonally. At the bottom of the grid, the text "PSC ferencak" is written in a stylized font.





LANCI



LANAC ISO STANDARD JEDNOREDNI	208
LANAC ISO STANDARD DVOREDNI	209
LANAC ISO STANDARD TROREDNI	209
LANAC ISO STANDARD DVOSTRUKI KORAK	210
LANCI ZA POLJOPRIVREDNE STROJEVE	210
TRANSPORTNI LANAC	211
UVLAČNI LANAC	212-215
SPOJNICE I POLUSPOJNICE	216

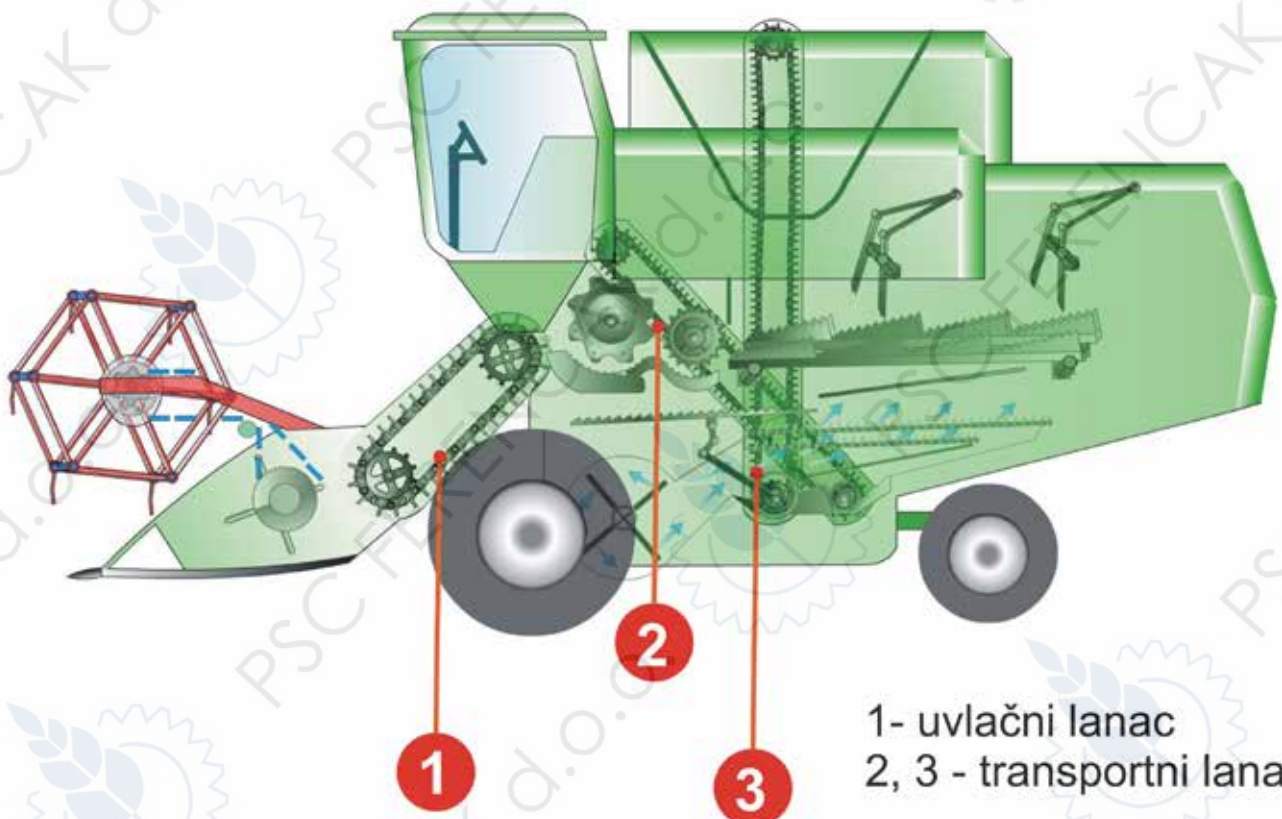

1- uvlačni lanac
2, 3 - transportni lanac

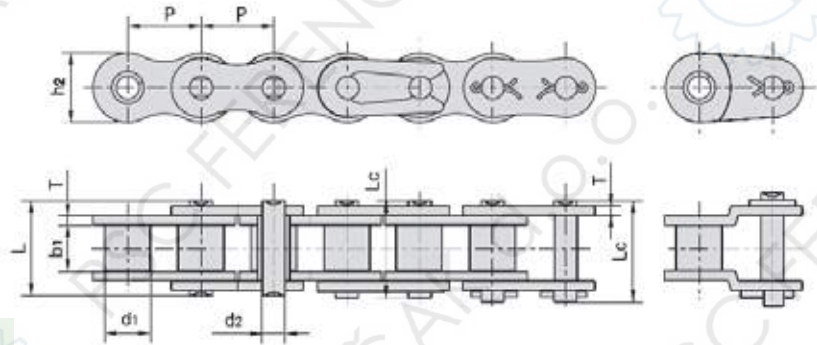
**LANCI ISO STANDARD JEDNOREDNI****OJAČANI TAGEX**

Šifra	ISO	ANSI	P (mm)	d1 (mm)	b1 (mm)	d2 (mm)	L (mm)	Lc (mm)	h2 (mm)	T (mm)
191230	08A-1	40	12,70	7,95	7,85	3,96	16,60	17,80	12,00	1,50
191539	10A-1	50	15,88	10,16	9,40	5,08	20,70	22,20	15,09	2,03
191093	12A-1	60	19,05	11,91	12,57	5,94	25,90	27,70	18,00	2,42
191540	16A-1	80	25,40	15,88	15,75	7,92	32,70	35,00	24,00	3,25
193090	20A-1	100	31,75	19,05	18,90	9,53	40,40	44,70	30,00	4,00
194714	24A-1	120	38,10	22,23	25,22	11,10	50,30	54,30	35,70	4,80
200658	28A-1	140	44,45	25,40	25,22	12,70	54,40	59,00	41,00	5,60

OJAČANI DONGHUA

Šifra	ISO	ANSI	P (mm)	d1 (mm)	b1 (mm)	d2 (mm)	L (mm)	Lc (mm)	h2 (mm)	T (mm)
202439	16A-1	80	25,40	15,88	15,75	7,92	32,70	35,00	24,00	3,25
202626	20A-1	100	31,75	19,05	18,90	9,53	40,40	44,70	30,00	4,00
203700	28A-1	140	44,45	25,40	25,22	12,70	54,40	59,00	41,00	5,60

EXSTRA OJAČANI TAGEX

Šifra	ISO	ANSI	P (mm)	d1 (mm)	b1 (mm)	d2 (mm)	L (mm)	Lc (mm)	h2 (mm)	T (mm)
201803	10AH-1	50H-1	-	-	-	-	-	-	-	-
193931	12AH-1	60H-1	19,05	11,91	12,57	5,94	29,20	31,00	18	3,25
193898	16AH-1	80H-1	25,40	15,88	15,75	7,92	36,20	37,70	24	4,00
198560	20AH-1	100H-1	31,75	19,05	18,90	9,53	43,60	46,90	30	4,80

STANDARD TAGEX

Šifra	ISO	P (mm)	d1 (mm)	b1 (mm)	d2 (mm)	L (mm)	Lc (mm)	h2 (mm)	T (mm)
190052	06B-1	9,53	6,35	5,72	3,28	13,15	14,10	8,20	1,30
191089	081	12,70	7,75	3,30	3,66	10,20	11,70	9,90	-
191091	083	12,70	7,75	4,88	4,09	12,90	14,40	10,30	-
190060	084	-	-	-	-	-	-	-	-
191233	085	12,70	7,77	6,38	3,58	14,00	16,00	9,90	-
190053	08B-1	12,70	8,51	7,75	4,45	16,70	18,20	11,80	1,60
190054	10B-1	15,88	10,16	9,65	5,05	19,50	20,90	14,70	1,70
190384	12B-1	19,05	12,07	11,68	5,72	22,50	24,20	16,00	1,85
190385	16B-1	25,40	15,88	17,02	8,28	36,10	37,40	21,00	3,10
190057	20B-1	31,75	19,05	19,56	10,19	41,30	45,00	26,40	3,50
190059	24B-1	38,10	25,40	25,40	14,63	53,40	57,80	33,20	4,80



LANCI ISO STANDARD JEDNOREDNI

STANDARD DONGHUA

Šifra	ISO	P (mm)	d1 (mm)	b1 (mm)	d2 (mm)	L (mm)	Lc (mm)	h2 (mm)	T (mm)
203699	10B-1	15,88	10,16	9,65	5,05	19,50	20,90	14,70	1,70
202912	16B-1	25,40	15,88	17,02	8,28	36,10	37,40	21,00	3,10
203440	20B-1	31,75	19,05	19,56	10,19	41,30	45,00	26,40	3,50

LANCI ISO STANDARD DVOREDNI

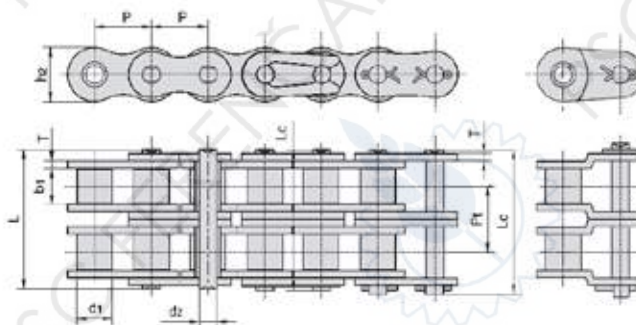

OJAČANI DVOREDNI

Šifra	ISO	ANSI	P (mm)	d1 (mm)	b1 (mm)	d2 (mm)	L (mm)	Lc (mm)	h2 (mm)	T (mm)	Pt (mm)
192669	10A-2	50-2	12,70	10,16	9,40	5,08	38,90	40,40	15,09	2,03	18,11
190058	12A-2	60-2	19,09	11,91	12,57	5,94	48,80	50,50	18,00	2,42	22,78
193276	16A-2	80-2	25,40	15,88	15,75	7,92	62,70	64,30	24,00	3,25	29,29

STANDARD DVOREDNI

Šifra	ISO	P (mm)	d1 (mm)	b1 (mm)	d2 (mm)	L (mm)	Lc (mm)	h2 (mm)	T (mm)	Pt (mm)
193085	08B-2	12,70	8,51	7,75	4,45	31,00	32,20	11,80	1,60	13,92
194097	10B-2	15,87	10,16	9,65	5,08	36,10	37,50	14,70	1,70	16,59
190055	12B-2	19,05	12,07	11,68	5,72	42,00	43,60	16,00	1,85	19,46
190576	16B-2	25,40	15,88	17,02	8,28	68,00	69,30	21,00	3,10	31,88

17

LANCI ISO STANDARD TROREDNI

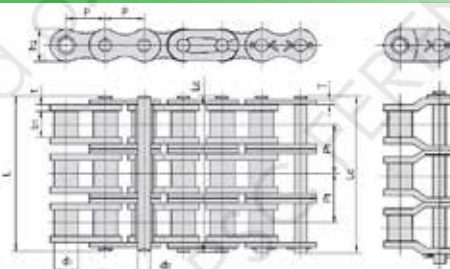

OJAČANI TROREDNI

Šifra	ISO	ANSI	P (mm)	d1 (mm)	b1 (mm)	d2 (mm)	L (mm)	Lc (mm)	h2 (mm)	T (mm)	Pt (mm)
192283	12A-3	60-3	19,05	11,91	12,57	5,94	71,50	73,30	18,00	2,42	22,78

STANDARD TROREDNI

Šifra	ISO	P (mm)	d1 (mm)	b1 (mm)	d2 (mm)	L (mm)	Lc (mm)	h2 (mm)	T (mm)	Pt (mm)
192570	10B-3	15,87	10,16	9,65	5,08	52,70	54,10	14,70	1,70	16,59
195432	12B-3	19,05	12,07	11,68	5,72	61,50	63,10	16,00	1,85	19,46
191719	16B-3	25,40	15,88	17,02	8,28	99,80	101,20	21,00	3,10	31,88
193916	20B-3	31,75	19,05	19,56	10,19	114,20	117,90	26,40	3,50	36,45



LANCI ISO STANDARD DVOSTRUKI KORAK

DVOSTRUKI KORAK

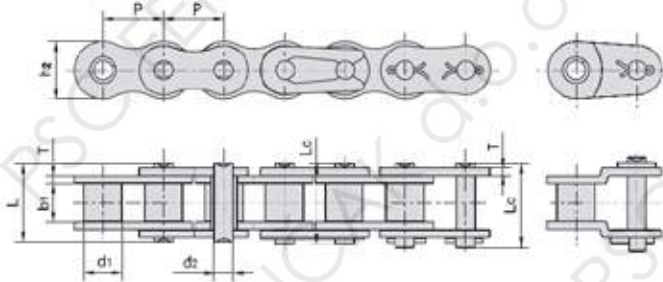

Šifra	ISO	ANSI	P (mm)	d1 (mm)	b1 (mm)	d2 (mm)	L (mm)	Lc (mm)	h2 (mm)	T (mm)
192135	208A	2040	25,40	7,95	7,85	3,96	16,60	17,80	12,00	1,50
190386	208B	-	25,40	8,51	7,75	4,45	16,70	18,20	11,80	1,60
192140	210A	2050	31,75	10,16	9,40	5,08	20,70	22,20	15,00	2,03
190369	210B	-	31,75	10,16	9,65	5,08	19,50	20,90	14,70	1,70
194612	212A	2060	38,10	11,91	12,57	5,94	25,90	27,70	18,00	2,42
196732	216B	-	50,80	15,88	17,02	8,28	36,10	39,10	21,00	3,10

LANCI ZA POLJOPRIVREDNE STROJEVE

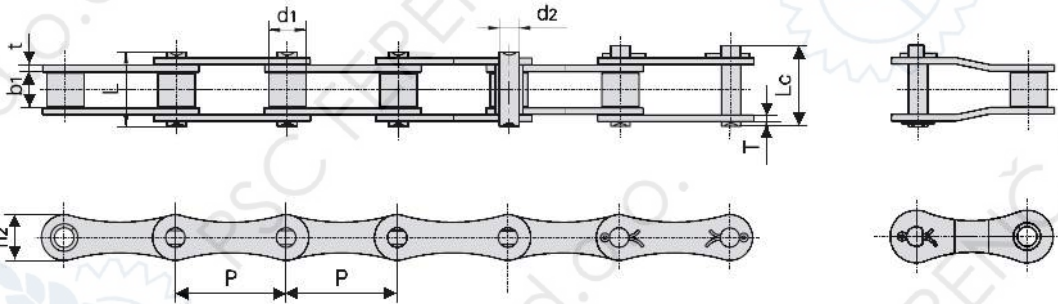

17

ŠIFRA	ISO	P (mm) max	d1 (mm) max	b1 (mm) min	d2 (mm) max	L (mm) max	Lc (mm) max	h2 (mm) max	t/T (mm) max
190767	S32	29,21	11,43	15,88	4,45	26,7	28,8	13,2	1,8
193975	S52	38,1	15,24	22,23	5,72	37,7	40,4	17,3	2,8
191405	S55	41,4	17,78	22,23	5,72	37,7	40,4	17,3	2,8
193976	S62	41,91	19,05	26,2	5,72	40,3	43	17,3	2,5

CA tip lanca

ŠIFRA	ISO	P (mm) max	d1 (mm) max	b1 (mm) min	d2 (mm) max	L (mm) max	Lc (mm) max	h2 (mm) max	t/T (mm) max
192771	CA550	41,4	16,87	19,81	7,19	35	38	19,3	2,8



TRANSPORTNI LANCI

TRANSPORTNI LANAC

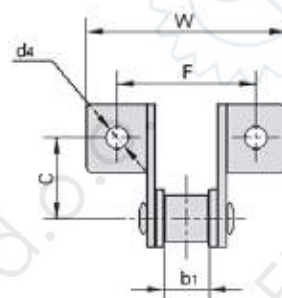
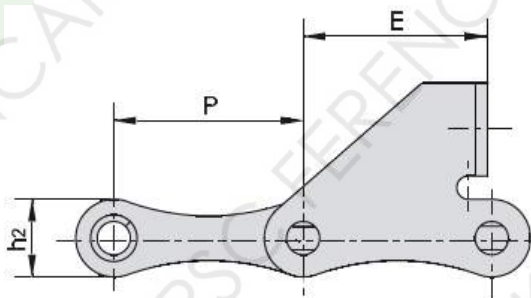

ŠIFRA	OZNAKA	P (mm)	b1 (mm)	C (mm)	E (mm)	F (mm)	W (mm)	d4 (mm)	h2 (mm)
191301	S55L4	41,4	22,23	20	37	58	87	6,6	17,3
192331	S55L6	41,4	22,23	20	37	58	87	6,6	17,3

L4 - Svaki četvrti članak je nosivi

L6 - Svaki šesti članak je nosivi

TRANSPORTNI LANAC

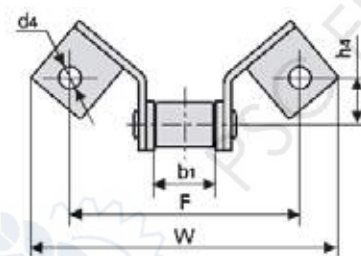
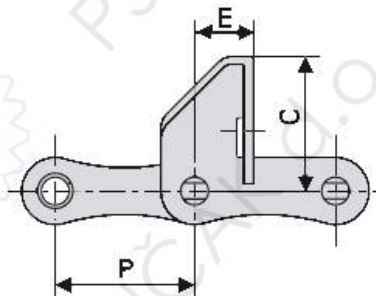

ŠIFRA	OZNAKA	P (mm)	b1 (mm)	C (mm)	E (mm)	F (mm)	W (mm)	d4 (mm)	h4 (mm)
193103	S55VSEL4	41,4	22,23	41	31,3	88	118	8,4	18,44
192286	S55VSEL6	41,4	22,23	41	31,3	88	118	8,4	18,44

L4 - Svaki četvrti članak je nosivi

L6 - Svaki šesti članak je nosivi

TRANSPORTNI LANAC

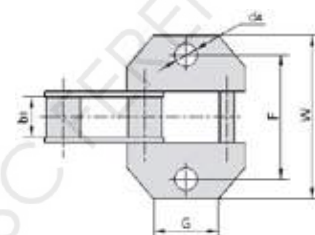
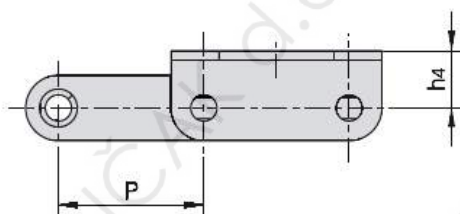

ŠIFRA	OZNAKA	P (mm)	b1 (mm)	G (mm)	F (mm)	W (mm)	h4 (mm)	d4 (mm)
190629	38,4R K1/L4	38,4	19,05	29,1	58	76,5	15,1	10,5
190630	38,4R K1/L6	38,4	19,05	29,1	58	76,5	15,1	10,5
191406	38,4VB K1/L2	38,4	19,05	29	58	87	14	10,5
191347	38,4VB K1/L4	38,4	19,05	29	58	87	14	10,5
191348	38,4VB K1/L6	38,4	19,05	29	58	87	14	10,5
192327	38,4V K1/L2	38,4	18	29,1	57	75	15,1	-
191302	38,4V K1/L4	38,4	18	22	57,5	82	15,4	-
192328	38,4V K1/L6	38,4	18	22	57,5	82	15,4	-

L2 - Svaki drugi članak je nosivi

L4 - Svaki četvrti članak je nosivi

L6 - Svaki šesti članak je nosivi

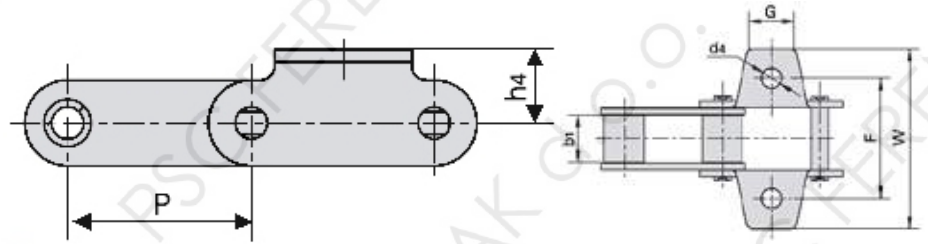
TRANSPORTNI LANCI
TRANSPORTNI LANAC

ŠIFRA	OZNAKA	P (mm)	b1 (mm)	G (mm)	F (mm)	W (mm)	h4 (mm)	d4 (mm)
191407	S55 L2	41,4	22,23	22	52	74	11,5	-
191408	S55 L4	41,4	22,23	22	52	74	11,5	-
190633	S55 L6	41,4	22,23	22	52	74	11,5	-

L2 - Svaki drugi članak je nosivi

L4 - Svaki četvrti članak je nosivi

L6 - Svaki šesti članak je nosivi

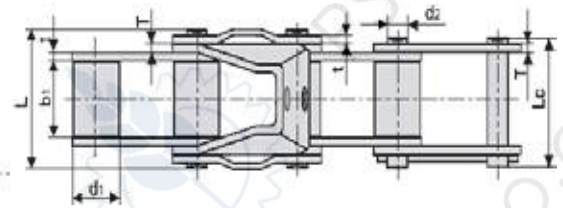
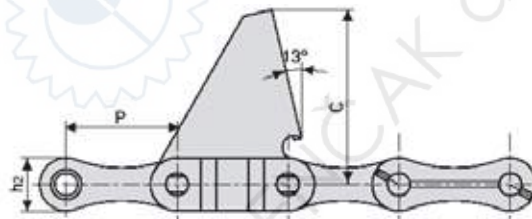
UVLAČNI LANCI
UVLAČNI LANAC (BOURGOIN)

ŠIFRA	OZNAKA	P (mm)	d1 (mm) max	b1 (mm) min	d2 (mm) max	L (mm) max	Lc (mm) max	h2 (mm) max	t/T (mm) max	C (mm)	Napomena
193794	S62R-C6E	41,91	19,05	25,8	8,5	47,8	44,6	20,1	2,8/3,0	66	Prodaje se komadno 64 članka
193795	S62R-C6E	41,91	19,05	25,8	8,5	47,8	44,6	20,1	2,8/3,0	66	Prodaje se u metrima

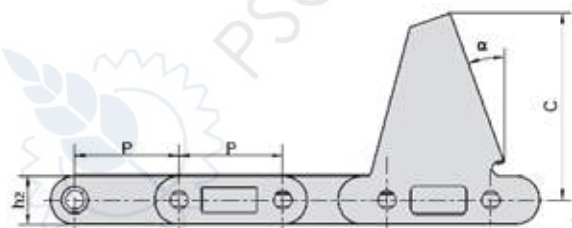
UVLAČNI LANAC (FANTINI, CAPELO)

ŠIFRA	OZNAKA	P (mm)	b1 (mm)	h2 (mm)	T (mm)	C (mm)	α
195465	CA550-CPE	41,4	19,81	19,3	2,8	64,9	20°

Lanac se prodaje komadno i ima 62 članka i osam kljunova!



UVLAČNI LANCI

UVLAČNI LANAC (GERING)

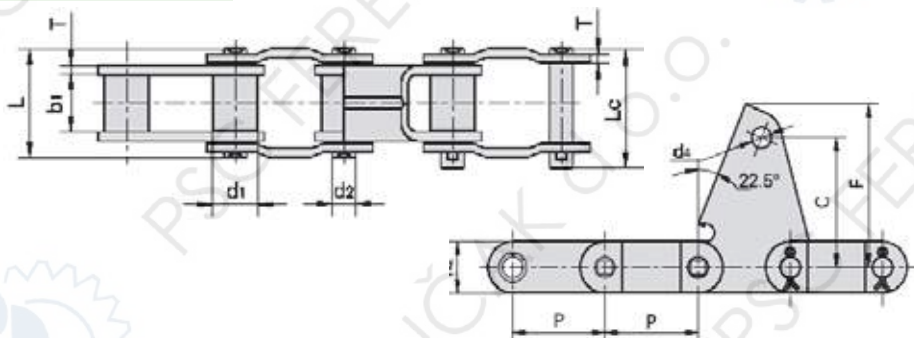

ŠIFRA	OZNAKA	P (mm)	d1 (mm) max	b1 (mm) min	d2 (mm) max	L (mm) max	Lc (mm) max	h2 (mm) max	T (mm) max	C (mm)	F (mm)	d4 (mm)
194790	38,4VB F2	38,4	15,88	19,05	8,28	36,1	39,1	20,5	3	51,6	65	8,1

Lanac se prodaje komadno i ima 64 članka i osam kljunova!

UVLAČNI LANAC (JOHN DEERE)

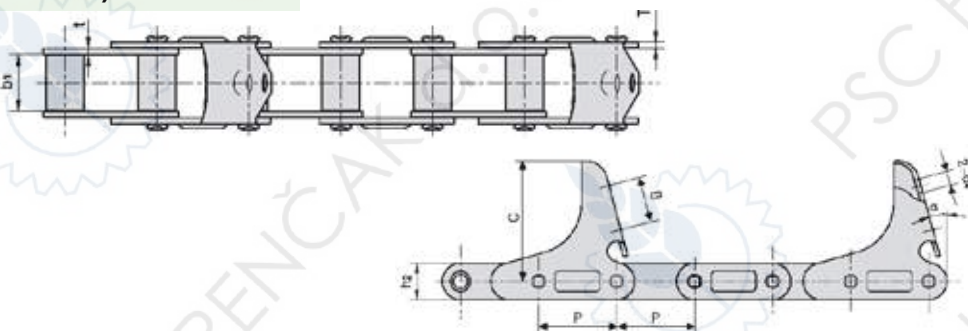

ŠIFRA	OZNAKA	P (mm)	b1 (mm)	h2 (mm)	T (mm)	C (mm)	α
199506	CA555-C6E	41,4	12,7	19,3	3,1	63,5	15°

Lanac se prodaje komadno i ima 48 članka i osam kljunova!

UVLAČNI LANAC (BERAČI KUKURUZA SIP)

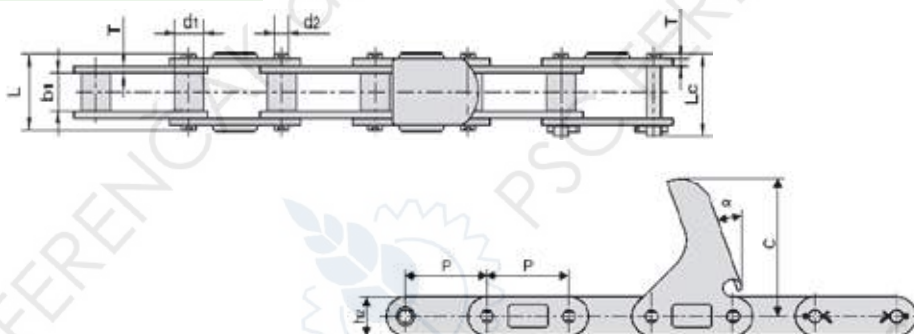

ŠIFRA	OZNAKA	P (mm)	d1 (mm) max	b1 (mm) min	d2 (mm) max	L (mm) max	Lc (mm) max	h2 (mm) max	T (mm) max	C (mm)	α
199459	CA2060-C6E	38,1	11,91	12,57	5,94	25,9	28,3	18	2,42	63,5	20°

Lanac se prodaje u metrima!

17

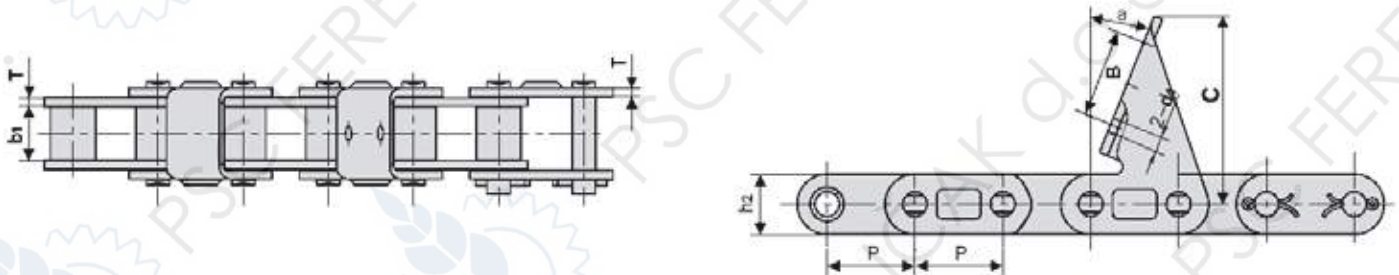
UVLAČNI LANCI
UVLAČNI LANAC (ĐURO ĐAKOVIĆ)

ŠIFRA	OZNAKA	P (mm)	b1 (mm)	h2 (mm)	B (mm)	d4 (mm)	T (mm)	C (mm)	α
199459	CA627-CPEF3	30	19,05	20,5	30	6	3	64	22°

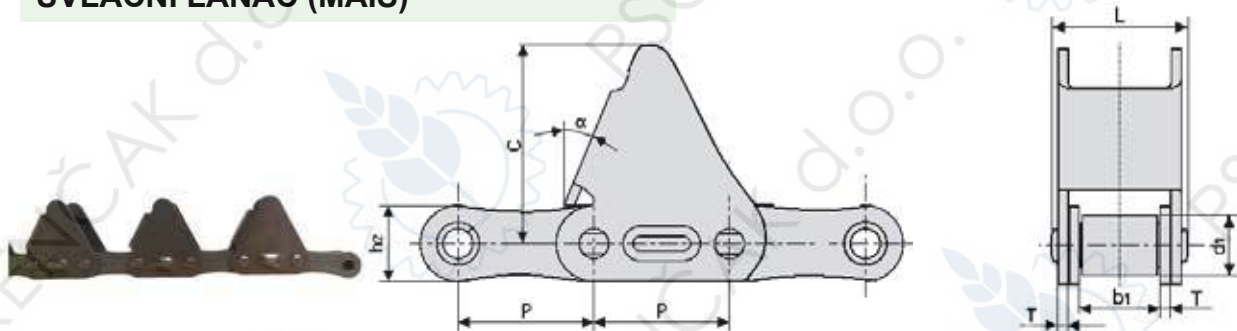
UVLAČNI LANAC (MAIS)

ŠIFRA	OZNAKA	P (mm)	d1 (mm)	b1 (mm)	L (mm)	h2 (mm)	T (mm)	C (mm)	α
195462	55H	41,4	15,5	22,5	39,7	21	3,5	51	22,5°

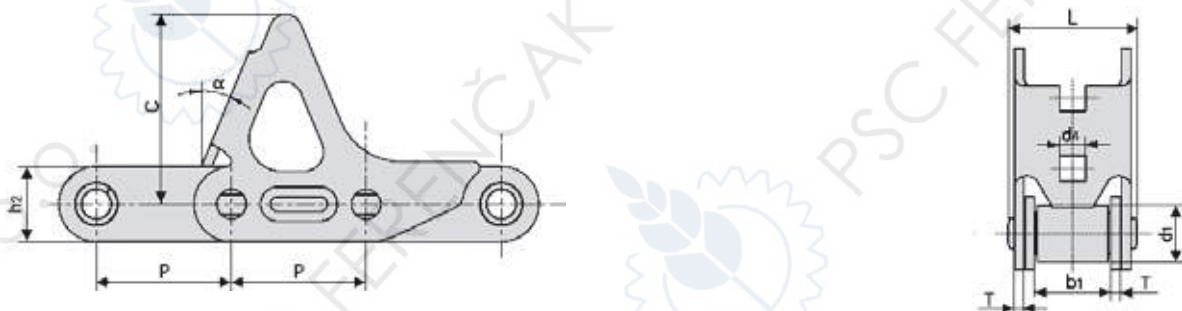
17
UVLAČNI LANAC (MAIS)

ŠIFRA	OZNAKA	P (mm)	d1 (mm)	b1 (mm)	L (mm)	h2 (mm)	T (mm)	C (mm)	α
195462	55VDF1-CPEF	41,4	17,9	22,5	39,7	23	3	58	22,5°



UVLAČNI LANCI

UVLAČNI LANAC 55VDF MAIS CLAAS JAGUAR

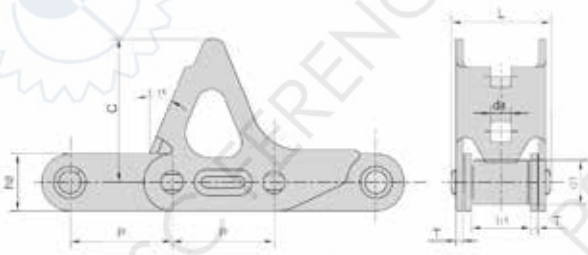

ŠIFRA	OZNAKA	P (mm)	b1 (mm)	h2 (mm)	L (mm)	d4 (mm)	T (mm)	C (mm)	Q (kN)
203434	55VD1-CPEF	41,40	22,50	23	39,70	8,10	3	58,00	1128

UVLAČNI LANAC CA206011 MAIS ZA BERAČ

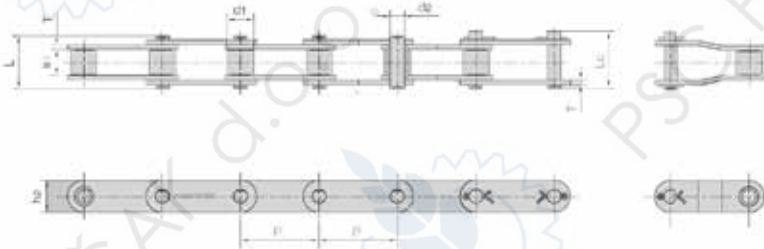

ŠIFRA	OZNAKA	P (mm)	b1 (mm)	h2 (mm)	L (mm)	Lc (mm)	T (mm)	C (mm)	Q (kN)
203435	CA2060H-6CE	38,10	12,57	18	31	31,6	3,25	63,50	6996

UVLAČNI LANAC CA555/F6 JOHN DEERE

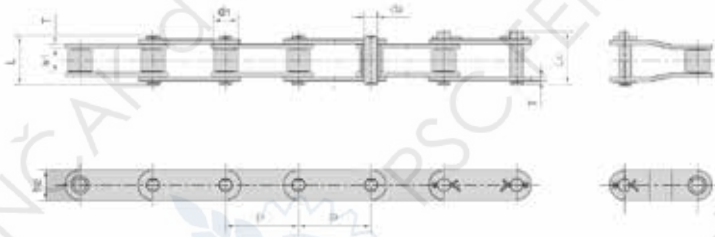

ŠIFRA	OZNAKA	P (mm)	b1 (mm)	h2 (mm)	b (mm)	d4 (mm)	T (mm)	C (mm)	Q (kN)
203436	CA555-C6EJ	41,40	12,70	19,30	25,40	5,50	3,10	66	-

UVLAČNI LANAC BOURGOIN S62/4

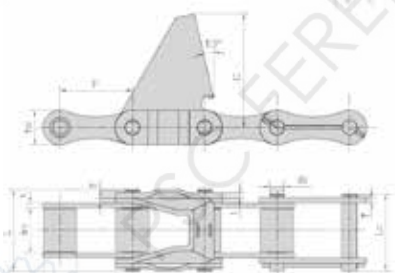

ŠIFRA	OZNAKA	P (mm)	b1 (mm)	d1 (mm)	L (mm)	Lc (mm)	T (mm)	C (mm)	Q (kN)
203437	S62R-C6E	41,91	25,80	19,05	47,80	44,60	3	66	9448

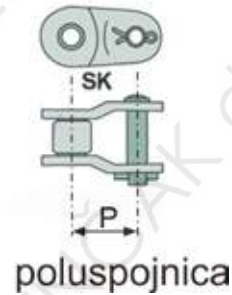
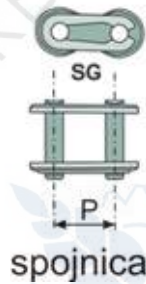
**SPOJNICE I POLUSPOJNICE**

SPOJNICE-član spojni SG		POLUSPOJNICE SK	
ŠIFRA	NAZIV	ŠIFRA	NAZIV
190061	06 B1	190071	06 B1
190735	06 B3		
191231	08 A1	191232	08 A1
190062	08 B1	190072	08 B1
193086	08 B2	193087	08 B2
192334	08 B3		
191598	10 A1	191541	10 A1
192670	10 A2		
190063	10 B1	190073	10 B1
194098	10 B2		
192572	10 B3	192573	10 B3
191094	12 A1	191095	12 A1
190067	12 A2	190079	12 A2
192284	12 A3	192285	12 A3
190064	12 B1	190074	12 B1
190068	12 B2	190075	12 B2
191351	12 B3	192574	12 B3
191542	16 A1	191543	16 A1
193279	16 A2	193280	16 A2
190387	16 B1	190076	16 B1
190577	16 B2	190578	16 B2
196423	16 B3		
193091	20 A1		
190066	20 B1	190078	20 B1
192490	20 B2	192491	20 B2
192926	20 B2 SY		
192697	24 A1	193089	24 A1
190069	24 B1	190080	24 B1
193930	60 H1	193929	60 H1
194713	80 H1 SY		
192330	80 H1	192332	80 H1
195228	80-1 SY	195230	80-1 SY

SPOJNICE ZA KOMBAJNSKE LANCE

ŠIFRA	NAZIV
190637	ČLAN SG 38,4 R
190635	ČLAN SG 38,4 R K1
190636	ČLAN SG 38,4 R SD
191304	ČLAN SG 38,4 V
191349	ČLAN SG 38,4 VB
190638	ČLAN SG 38,4 S 55
191409	ČLAN SG 38,4 S 55 K1
191306	ČLAN SG 30 mm Đ.Đ
192287	ČLAN SG 55 V
193179	ČLAN SG CA 550
193177	ČLAN SG S 55
192493	ČLAN SG S 62
190605	ČLAN SG BURGOIN S 62
192281	ČLAN SG S 52

POLUSPOJNICE ZA KOMBAJNSKE LANCE

ŠIFRA	NAZIV
192494	ČLAN SK S 62
190606	ČLAN SK BURGOIN
191088	ČLAN SK 38,4 R
191305	ČLAN SK 38,4 V
192488	ČLAN SK 38,4 VB
191307	ČLAN SK S 55
191087	ČLAN SK 30 MM Đ.Đ.
192288	ČLAN SK 55 V
193180	ČLAN SK CA 550
192282	ČLAN SK S 52



Prostor za bilješke



**KARDANI I DIJELOVI ZA
KARDANE**

IDENTIFIKACIJA KARDANA I DIJELOVA	220-222
KARDANI WALTERSCHEID	223-226
CIJEVI KARDANA WALTERSCHEID	226-227
KRIŽEVI KARDANA WALTERSCHEID	227
VILICE KARDANA WALTERSCHEID	227-233
SIGURNOSNA SKLOPKA WALTERSCHEID	233-237
IDENTIFIKACIJA KARDANSKIH ZGLOBOVA CERJAK	238
KARDANI CERJAK	239-241
KRIŽEVI KARDANA CERJAK	241
KRIŽEVI KARDANA TALIJANSKI	242
CIJEVI KARDANA	242-243
VILICE I SKLOPKE KARDANA CERJAK	243-245
KARDANSKE REDUKCIJE	246
SERVIS KARDANA	246

**Servis kardane, izmjena križeva kardana i skraćivanje cijevi po mjeri u
Križevcima, N.Tesle 12 i u Osijeku, Omladinska 128!**

NOVO





IDENTIFIKACIJA PRIKLJUČKA NA KARDANSKOM PRIKLJUČKU

OZNAKA

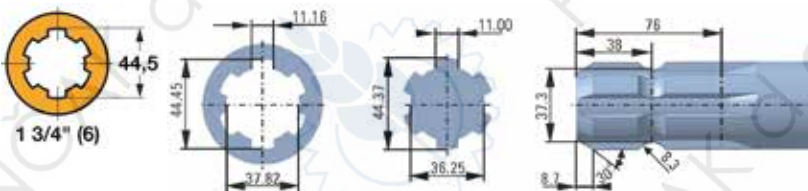
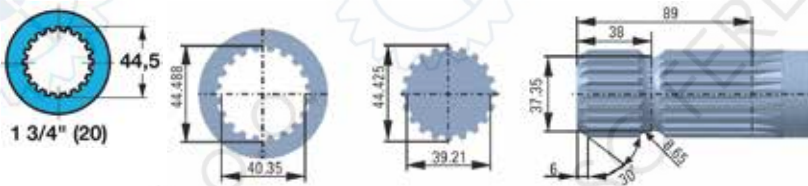
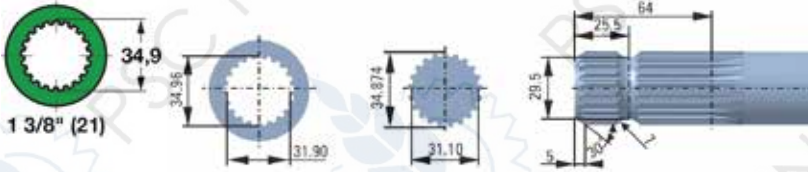
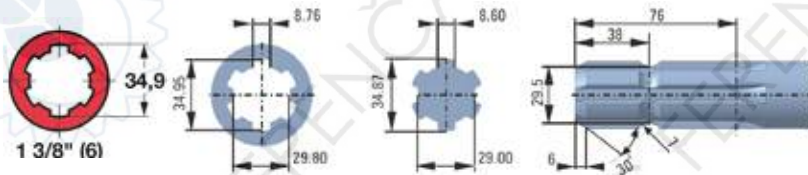

IDENTIFIKACIJA SIGURNOSNOG UČVRŠĆENJA VILICE

MODEL UČVRŠĆENJA

AG



MODEL UČVRŠĆENJA

AZGE



MODEL UČVRŠĆENJA

ASGE



MODEL UČVRŠĆENJA

ASG



MODEL UČVRŠĆENJA

QSG



MODEL UČVRŠĆENJA

ZV



MODEL UČVRŠĆENJA

CC



MODEL UČVRŠĆENJA

AGCC



MODEL UČVRŠĆENJA

KB





IDENTIFIKACIJA KARDANSKIH ZGLOBOVA

OZNAKA	KRIŽEVI	VILICE	CIJEVI	ZAŠITNA PLASTIKA
2000				
2100 W100				
2200 W200				
2300 W300				
2400 W400				
2500 W500				



IDENTIFIKACIJA KARDANSKIH ZGLOBOVA

OZNAKA	KRIŽEVI	VILICE	CIJEVI	ZAŠTITNA PLASTIKA
2600 W600				
2700 W700				

IDENTIFIKACIJA KARDANSKIH DUPLIH ZGLOBOVA

OZNAKA	KRIŽEVI	VILICE	CIJEVI	ZAŠTITNA PLASTIKA
2280				
2380				
2380				
2480				

18



KARDANI WALTERSCHEID

Bez sklopke

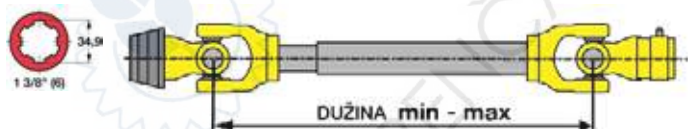

ŠIFRA	OZNAKA JAČINE	OZNAKA SIGUR. UČVRŠĆENJA	KRIŽ mm	DUŽINA min - max	CIJEV
196770	W100	AG/QSG	22x55	560 - 770	00c/0a
197751	W100	AG/QSG	22x55	710 - 920	00c/0a
197169	W100	AG/QSG	22x55	860 - 1070	00c/0a
197553	W100	AG/QSG	22x55	1010 - 1220	00c/0a
196772	W200	AG/QSG	24x61	710 - 920	0v/1
197752	W200	AG/QSG	24x61	860 - 1070	0v/1
196773	W200	AG/QSG	24x61	1010 - 1220	0v/1
197250	W200	AG/QSG	24x61	1210 - 1420	0v/1
197573	W300	AG/QSG	27x75	710 - 920	0v/1
197522	W300	AG/QSG	27x75	860 - 1070	0v/1
197302	W300	AG/QSG	27x75	1210 - 1420	0v/1
197590	W400	AG/QSG	32x76	560 - 770	1b/2a
197591	W400	AG/QSG	32x76	1010 - 1220	1b/2a
197592	W400	AG/QSG	32x76	1210 - 1420	1b/2a

Bez jedne vilice

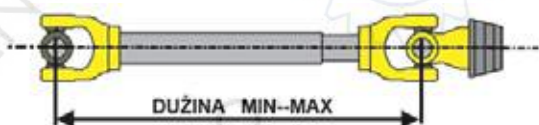

ŠIFRA	OZNAKA JAČINE	OZNAKA SIGUR. UČVRŠĆENJA	KRIŽ mm	DUŽINA min - max	CIJEV
197753	W300	ASGE	27x75	710 - 920	0v/1
197754	W300	ASGE	27x75	1010 - 1220	0v/1
197755	W400	ASGE	32x76	560 - 770	1b/2a
197756	W400	ASGE	32x76	860 - 1070	1b/2a
197757	W400	ASGE	32x76	1010 - 1220	1b/2a

Bez sklopke



ŠIFRA	OZNAKA JAČINE	OZNAKA SIGUR. UČVRŠĆENJA	KRIŽ mm	DUŽINA min - max	CIJEV
194272	W200	AG/AG	24x61	710 - 985	0v/1
194268	W300	AG/AG	27x75	710 - 985	0v/1
194286	W400	AG/AG	32x76	710 - 985	1b/2a
194269	W400	AG/AG	32x76	1010 - 1435	1b/2a
197765	W2500	AG/AG	36x89	710 - 1170	S4/S5
197249	W2500	ASG/AG	36x89	1210 - 1700	S4/S5



KARDANI WALTERSCHEID

Bez sklopke



ŠIFRA	OZNAKA JAČINE	OZNAKA SIGUR. UČVRŠĆENJA	KRIŽ mm	DUŽINA min - max	CIJEV
194267	W2500	-	36x89	710 - 1170	S4/S5

Bez vilica

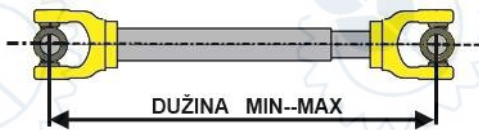

ŠIFRA	OZNAKA JAČINE	OZNAKA SIGUR. UČVRŠĆENJA	KRIŽ mm	DUŽINA min - max	CIJEV
194925	W2500	-	36x89	1210 - 1700	S4/S5
196351	W2600	-	42x104	860 - 1165	S5/S6

Sa sigurnosnom sklopkom

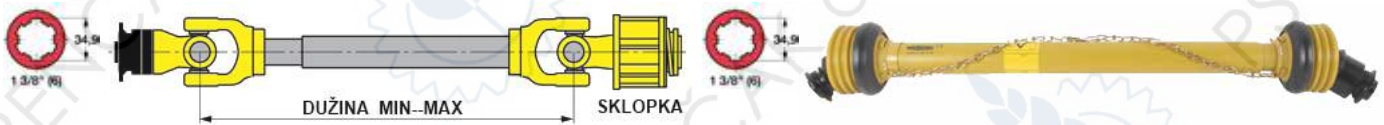

ŠIFRA	OZNAKA JAČINE	JAČINA SKLOPKE	OZNAKA SIGUR. UČVRŠĆENJA	KRIŽ mm	DUŽINA min - max	CIJEV
194277	W300	600Nm	AG/ZV	27x75	1010 - 1435	0v/1
195723	W300	900Nm	AG/ZV	27x75	1010 - 1435	0v/1
195164	W400	1200Nm	AG/ZV	32x76	1010 - 1435	1b/2a

18

S tarnom sklopkom

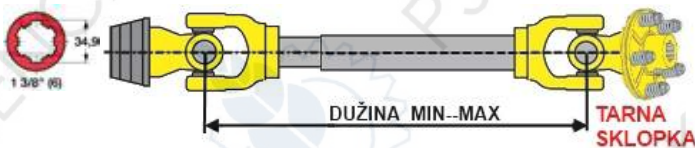

ŠIFRA	OZNAKA JAČINE	JAČINA SKLOPKE	OZNAKA SIGUR. UČVRŠĆENJA	KRIŽ mm	DUŽINA min - max	CIJEV
196637;194493	W400	1200Nm	AZGE/KB	32x76	710 - 1170	1b/2a

S tarnom sklopkom

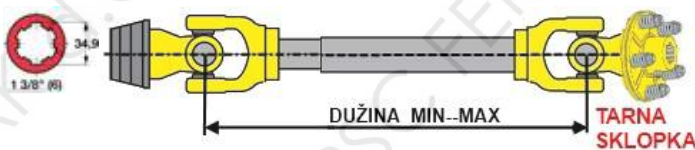

ŠIFRA	OZNAKA JAČINE	JAČINA SKLOPKE	OZNAKA SIGUR. UČVRŠĆENJA	KRIŽ mm	DUŽINA min - max	CIJEV
194491	W2500	1200Nm	ASG/KB	36x89	710 - 1170	S4/S5
196350	W2600	1400Nm	AG/KB	42x104	710 - 1170	S4/S5



KARDANI WALTERSCHEID

S tarnom sklopkom



ŠIFRA	OZNAKA JAČINE	JAČINA SKLOPKE	OZNAKA SIGUR. UČVRŠĆENJA	KRIŽ mm	DUŽINA min - max	CIJEV
196349	W2600	1400Nm	AZGE/KB	42x104	710 - 1170	S4/S5

S protočnom sklopkom



ŠIFRA	OZNAKA JAČINE	OZNAKA SKLOPKE	OZNAKA SIGUR. UČVRŠĆENJA	KRIŽ mm	DUŽINA min - max	CIJEV
194273	W200	F5/1R	AZGE/ZV	24x61	1010 - 1435	0v/1
194492	W300	F5/1R	AZGE/ZV	25x75	710 - 1170	0v/1
194270	W400	F5/1R	AZGE/ZV	32x76	710 - 1170	1b/2a
194991	W2400	F5/1	ASG/ZV	32x76	1110 - 1550	S4/S5
194985	W2500	F5/1	ASG/ZV	36x89	1010 - 1435	S4/S5
194990	W2500	F5/2	ASG/AGCC	36x89	1010 - 1435	S4/S5

S jednim duplim zglobom

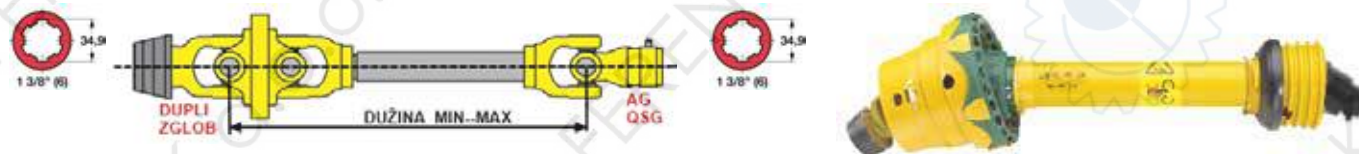

ŠIFRA	OZNAKA JAČINE	OZNAKA SIGUR. UČVRŠĆENJA	KRIŽ mm	DUŽINA min - max	CIJEV
194740	W2280	ASGE/AG	24x61/22x76	1010 - 1420	0vGA/1G
194494	W2380	ASGE/AG	27x75/24x91	1010 - 1420	0vGA/1G
199669	W2380	ASGE/AG	27x75/24x91	1010 - 1420	1bGA/2aG
194276	W2480	ASGE/AG	32x76/27x94	1210 - 1620	1bGA/2aG
197428	W2480	ASGE/AG	32x76/27x94	1410 - 1880	1bGA/2aG
194274	W2580	ASG/AG	36x89/32x106	1210 - 1620	S4GA/S5

S jednim duplim zglobom bez vilice



ŠIFRA	OZNAKA JAČINE	OZNAKA SIGUR. UČVRŠĆENJA	KRIŽ mm	DUŽINA min - max	CIJEV
196500	W2280	-	24x61/22x76	1010 - 1420	0vGA/1G



KARDANI WALTERSCHEID

S jednim duplim zglobom i sigurnosnom sklopkom



ŠIFRA	OZNAKA JAČINE	JAČINA SKLOPKE	OZNAKA SIGUR. UČVRŠĆENJA	KRIŽ mm	DUŽINA min - max	CIJEV
194491	W2380	800Nm	AG/KB	27x75/24x91	1010 - 1420	0vGA/1G

S jednim duplim zglobom i protočnom sklopkom



ŠIFRA	OZNAKA JAČINE	OZNAKA SKLOPKE	OZNAKA SIGUR. UČVRŠĆENJA	KRIŽ mm	DUŽINA min - max	CIJEV
194290	W2380	F5/1R	AG/KB	27x75/24x91	1010 - 1420	0vGA/1G

CIJEVI KARDANA WALTERSCHEID

ŠIFRA	NAZIV	ŠIFRA	NAZIV
194278	Cijev kardana 00a Walterscheid ORIGINAL	194282	Cijev kardana 1b Walterscheid ORIGINAL
		198545	Zamjenska
	00a		
			1b
195721	Cijev kardana 00c Walterscheid ORIGINAL	194283	Cijev kardana 2a Walterscheid ORIGINAL
		198544	Zamjenska
	00c		
			2a
194279	Cijev kardana 0a Walterscheid ORIGINAL	194284	Cijev kardana S4 Walterscheid ORIGINAL
		198736	Zamjenska
	0a		
			S4
194280	Cijev kardana 0v Walterscheid ORIGINAL	194285	Cijev kardana S5 Walterscheid ORIGINAL
198734	Zamjenska	198737	Zamjenska
	0v		S5
194281	Cijev kardana 1 Walterscheid ORIGINAL	197023	Cijev kardana S6 Walterscheid ORIGINAL
198735	Zamjenska		
	1		S6



CIJEVI KARDANA WALTERSCHEID

ŠIFRA	NAZIV	ŠIFRA	NAZIV
020013L	Cijev kardana 04	190644	Cijev kardana 08
Cijevi se prodaju u paru		Cijevi se prodaju u paru	

KRIŽ KARDANA WALTERSCHEID STANDARD

KRIŽ KARDANA ZA DUPLI ZGLOB

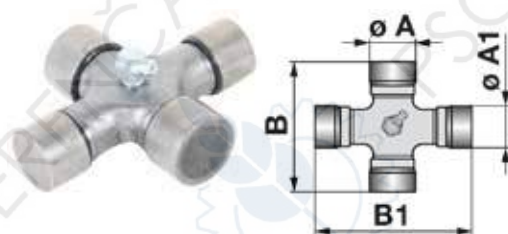
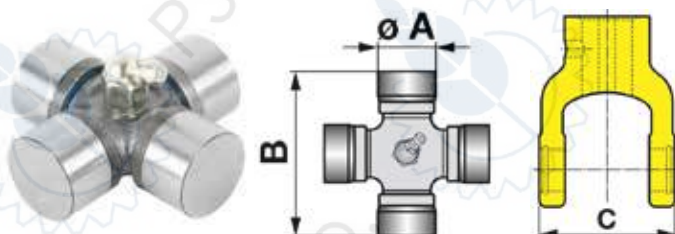

ŠIFRA	OZNAKA JAČINE	DIMENZIJE Ax B mm	C mm
194240	2100	22x55	63
194242	2200	26x61	70
194243	2300	27x75	84
194538	2400	32x76	86
194540	2500	36x89	100
195542	2600	42x104	120

ŠIFRA	OZNAKA JAČINE	DIMENZIJE Ax B / A1 x B1 mm	C mm
194536	WW2280	26x61 / 22x76	70
194537	WW2380	27x75 / 24x91	84
194539	WW2480	32x76 / 27x94	86
194541	WW2580	36x89 / 32x106	100

STARI MODELI

194245	W I	27x70	77
194246	W II	34x90	88
194241	W220	30x92	101
194244	W240	35x106,5	116

VILICA PRIKLJUČNA KARDANA WALTERSCHEID STANDARD -AG-

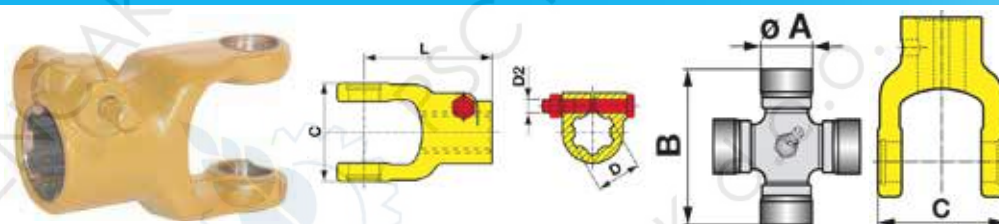

ŠIFRA	OZNAKA JAČINE	Dužina L mm	promjer D mm	Križ Ax B mm	C mm
194724	2100	89	34,9	22x55	63
194220	2200	98	34,9	24x61	70
194231	I	102	34,9	27x70	77
194232	II	112	34,9	34x90	88
197301	2300	107	34,9	27x75	84
194224	2400	112	34,9	32x76	86
194228	2500	118	34,9	36x89	100
194504	2600	128	34,9	42x104	120

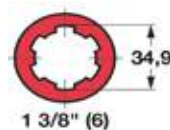

199422	2300	107	34,9	27x75	84
194226	2400	112	34,9	32x76	86
194230	2500	118	34,9	36x89	100
194505	2600	128	34,9	42x104	120

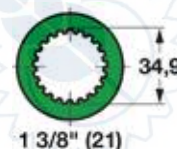



VILICA PRIKLJUČNA KARDANA WALTERSCHEID STANDARD -AG-

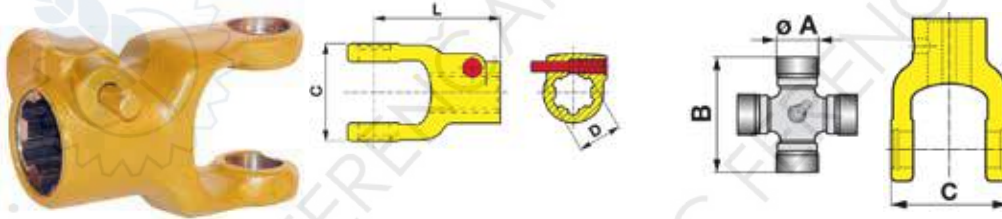

ŠIFRA	OZNAKA JAČINE	Dužina L mm	promjer D mm	Križ Ax B mm	C mm
194218	2100	90	28,5	22x55	63

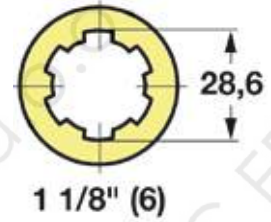

ŠIFRA	OZNAKA JAČINE	Dužina L mm	promjer D mm	Križ Ax B mm	C mm
194221	2300	111	44,5	27x75	84
194223	2400	112	44,5	32x76	86
194227	2500	118	44,5	36x89	100
196113	2600	128	44,5	42x104	120

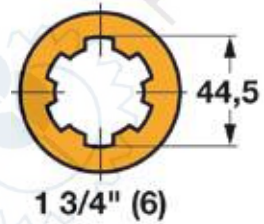

ŠIFRA	OZNAKA JAČINE	Dužina L mm	promjer D mm	Križ Ax B mm	C mm
194496	2300	111	44,5	27x75	84
194225	2400	112	44,5	32x76	86
194229	2500	118	44,5	36x89	100
196025	2600	128	44,5	42x104	120

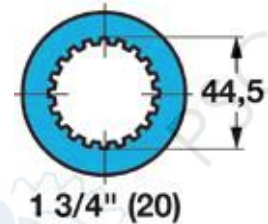

ŠIFRA	NAZIV	ŠIFRA	NAZIV
194507	Štift kardana AGRISSET 101 Za vilice: 1 1/8" 6Z 1 3/8" 6Z 1 3/8" 21Z	194506	Štift kardana AGRISSET 100 Za vilice: 1 1/8" 6Z 1 3/8" 6Z

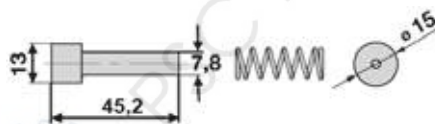

VILICA PRIKLJUČNA KARDANA WALTERSCHEID STANDARD -QSG-

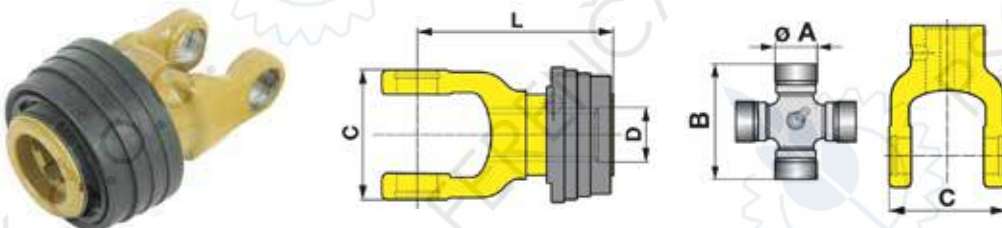

ŠIFRA	OZNAKA JAČINE	Dužina L mm	promjer D mm	Križ Ax B mm	C mm
197440	2100	114	34,9	22x55	63
197441	2300	125	34,9	27x75	84
197316	2500	133	34,9	36x89	100

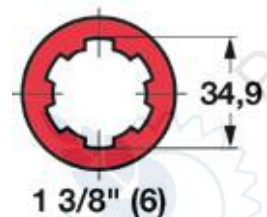



VILICA PRIKLJUČNA WALTERSCHEID STANDARD -AGCC-

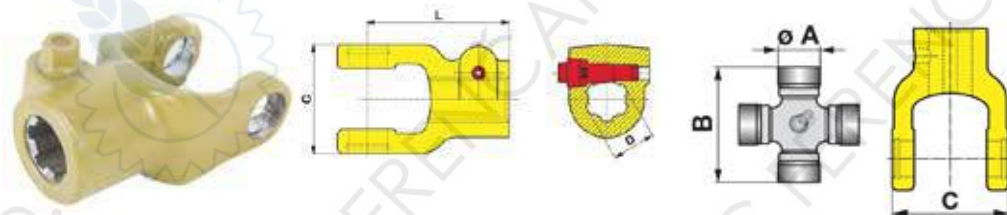

ŠIFRA	OZNAKA JAČINE	Dužina L mm	promjer D mm	promjer vijka	Križ AxB mm	C mm
199780	2500	118	34,9	12,5	36x89	100
198825	2600	128	34,9	12,5	42x104	120

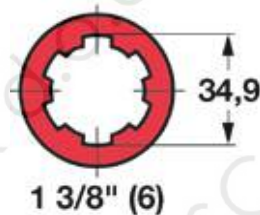

ŠIFRA	OZNAKA JAČINE	Dužina L mm	promjer D mm	promjer vijka	Križ AxB mm	C mm
195727	2400	112	34,9	12,5	32x76	86
195729	2500	118	34,9	12,5	36x89	100
199781	2600	128	34,9	12,5	42x104	120

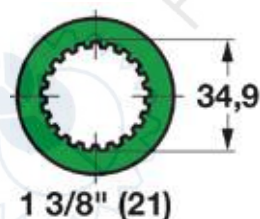

ŠIFRA	OZNAKA JAČINE	Dužina L mm	promjer D mm	promjer vijka	Križ AxB mm	C mm
199783	2500	118	44,5	15,8	36x89	100
197819	2600	128	44,5	15,8	42x104	120

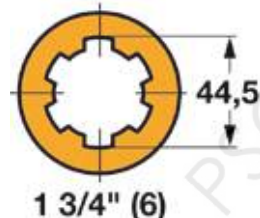

ŠIFRA	OZNAKA JAČINE	Dužina L mm	promjer D mm	promjer vijka	Križ AxB mm	C mm
195728	2400	112	44,5	15,8	32x76	86
195730	2500	118	44,5	15,8	36x89	100
196765	2600	128	44,5	15,8	42x104	120

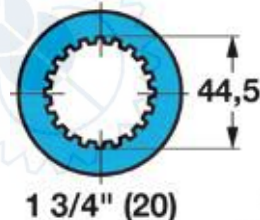

ŠIFRA	NAZIV	ŠIFRA	NAZIV
194507	Vijak vilice kardana Za vilice: 1 1/8" 6Z 1 3/8" 6Z 1 3/8" 21Z	194506	Vijak vilice kardana Za vilice: 1 3/4" 6Z 1 3/4" 20Z

VILICA PRIKLJUČNA WALTERSCHEID STANDARD -2xAG-

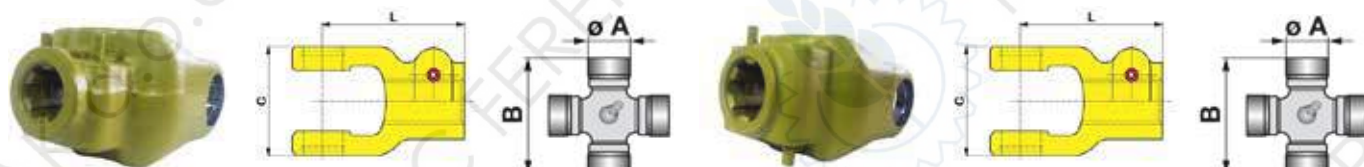

ŠIFRA	Jačina	Priključak	L mm	AxB mm	C mm	ŠIFRA	Jačina	Priključak	L mm	AxB mm	C mm
194503	2600	1 3/8" Z6	128	42x104	120	194503	2600	1 3/4" Z6	128	42x104	120
194505	2600	1 3/8" Z21	128	42x104	120						



VILICA PRIKLJUČNA WALTERSCHEID STANDARD -NG-

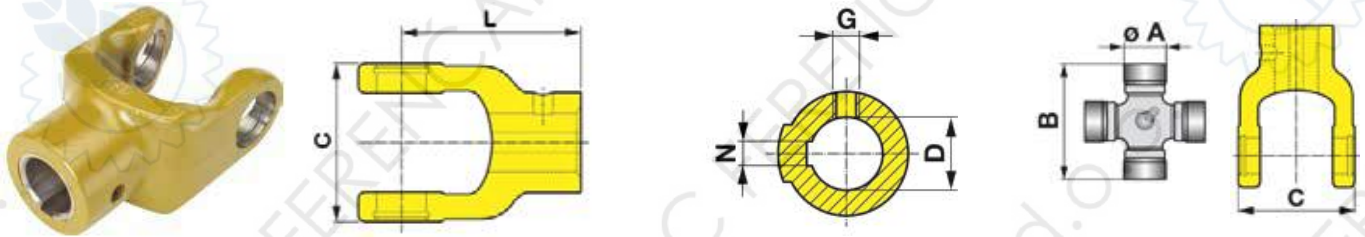

ŠIFRA	OZNAKA JAČINE	Dužina L mm	Promjer D mm	Kajla N mm	G	Križ AxB mm	C mm
197437	2200	80	25	8	M10	24x61	70
194247	2200	80	30	8	M10	24x61	70
197438	2300	95	25	8	M12	27x75	84
194248	2300	95	30	8	M12	27x75	84
194249	2300	95	35	10	M12	27x75	84
192359	2400	105	30	8	M12	32x76	86
198805	2400	112	35	10	M12	32x76	86
198836	2400	112	40	12	M12	32x76	86

VILICA PRIKLJUČNA WALTERSCHEID DUPLI ZGLOB -AG-

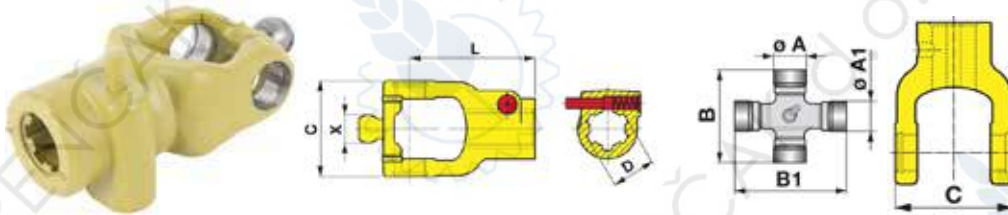

ŠIFRA	OZNAKA JAČINE	Dužina L mm	Promjer D mm	Promjer kugle X	Križ AxB/ A1xB1 mm	C mm
194715	2380	107	34,9	24	27x75/24x91	84
198683	2480	112	34,9	27	32x76/27x94	86
194500	2580	118	34,9	30	36x89/32x106	100

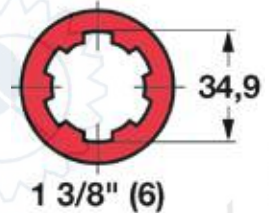

18

ŠIFRA	OZNAKA JAČINE	Dužina L mm	Promjer D mm	Promjer kugle X	Križ AxB/ A1xB1 mm	C mm
197020	2380	107	34,9	24	27x75/24x91	84
194498	2480	112	34,9	27	32x76/27x94	86
194502	2580	118	34,9	30	36x89/32x106	100

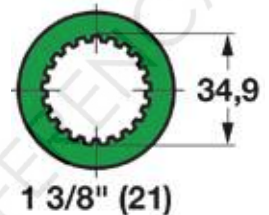

ŠIFRA	OZNAKA JAČINE	Dužina L mm	Promjer D mm	Promjer kugle X	Križ AxB/ A1xB1 mm	C mm
194921	2480	112	44,5	27	32x76/27x94	86
194499	2580	118	44,5	30	36x89/32x106	100

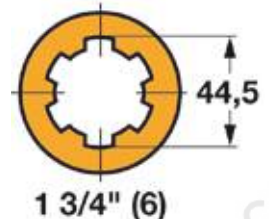

ŠIFRA	OZNAKA JAČINE	Dužina L mm	Promjer D mm	Promjer kugle X	Križ AxB/ A1xB1 mm	C mm
194497	2480	112	44,5	27	32x76/27x94	86
194501	2580	118	44,5	30	36x89/32x106	100

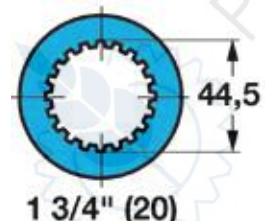



VILICA PRIKLJUČNA WALTERSCHEID DUPLI ZGLOB -QSG-

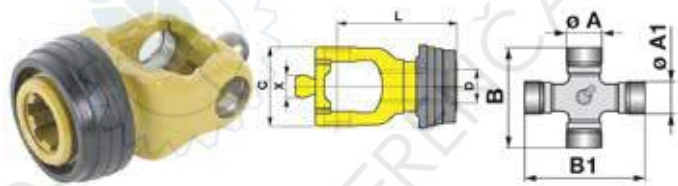

ŠIFRA	Jačina	Priključak	L mm	X mm	AxB/A1xB1	C mm
198005	2480	1 3/8"Z6	126	27	32x76/27x94	86

VILICA PRIKLJUČNA WALTERSCHEID DUPLI ZGLOB -QSG-

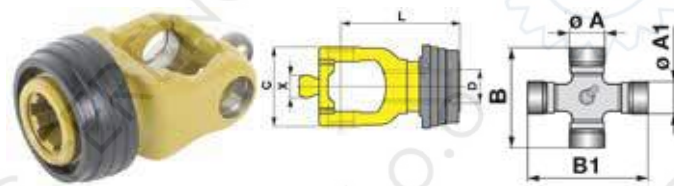

ŠIFRA	Jačina	Priključak	L mm	X mm	AxB/A1xB1	C mm
198003	2480	1 3/8"Z6	126	27	32x76/27x94	86

Set osigurača QSG

Za vilice:

196840	2100,2200,2300,2400	1 3/8" 6Z
192215	2500,2600	1 3/8" 6Z
198841	2300,2400,2500,2600	1 3/4" 6Z



Set osigurača ASG

Za vilice:

198119	2100,2200,2300,2400,2280, 2380,2480	1 3/8" 6Z i 1 3/8" 21Z
--------	--	------------------------



VILICA PRIKLJUČNA WALTERSCHEID DUPLI ZGLOB -AKGF-

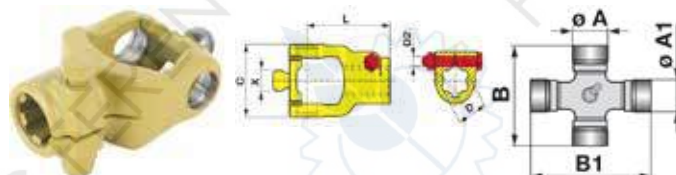

ŠIFRA	Jačina	Priključak	L mm	X mm	AxB/A1xB1	C mm
196769	2480	1 3/8"Z6	112	27	32x76/27x94	86

PRIRUBNICA PRIKLJUČNA WALTERSCHEID STANDARD -FG-

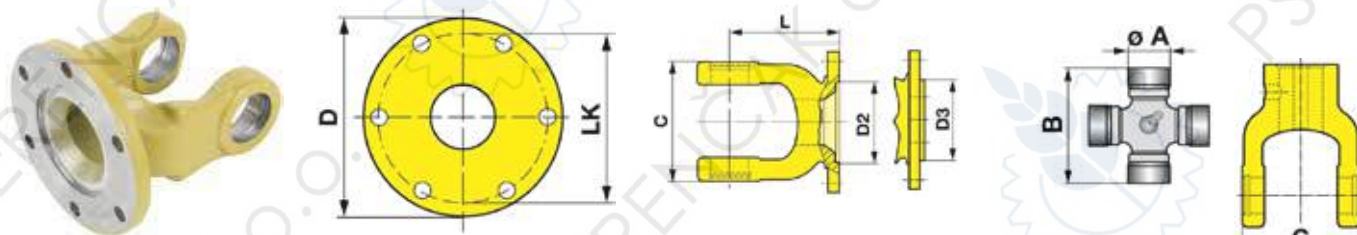

ŠIFRA	OZNAKA JAČINE	Dužina L mm	Promjer D mm	Promjer D2 mm	Razmak rupa LK mm	Križ AxB mm	C mm
194736	2100	52	100	57	84	22x55	63
195726	2300	78	100	57	84	27x75	84
199712	2400	84	100	57	84	32x76	86
193333	2500	72	160	98	138	36x89	100

18

PRIRUBNICA PRIKLJUČNA WALTERSCHEID STANDARD -DOPG-

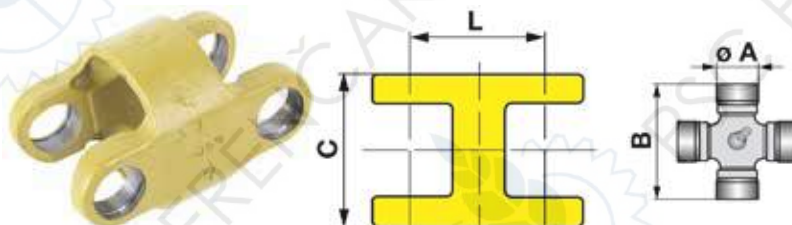

ŠIFRA	OZNAKA JAČINE	Dužina L mm	Križ AxB mm	C mm
194738	2100	65	22x55	63
198838	2200	78	24x61	70
194739	2300	75	27x75	84
198839	2300	115	27x75	84
195733	2400	100	32x76	86
195732	2500	118	36x89	100



VILICA CIJEVNA WALTERSCHEID STANDARD -RG-

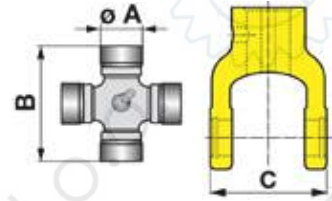
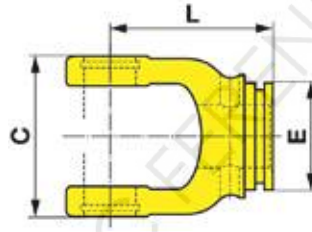

ŠIFRA	Oznaka jačine	Dužina L mm	Profil cijevi	Primjena	Promjer E mm	Križ Ax B mm	C mm
194250	2100	66	00c	Za unutarnju cijev	47	22x55	63
194936	2100	66	0a	Za vanjsku cijev	47	22x55	63
194251	2200	70	00c	Za unutarnju cijev	47	24x61	70
194252	2200	70	0a	Za vanjsku cijev	47	24x61	70
194253	2200	75	0v	Za unutarnju cijev	58	24x61	70
194254	2200	75	1	Za vanjsku cijev	58	24x61	70
194255	2300	85	0v	Za unutarnju cijev	58	27x75	84
194256	2300	85	1	Za vanjsku cijev	58	27x75	84
194257	2300	85	1b	Za unutarnju cijev	70	27x75	84
194258	2300	90	2a	Za vanjsku cijev	70	27x75	84
194259	2400	92	1b	Za unutarnju cijev	70	32x76	86
194260	2400	102	2a	Za vanjsku cijev	70	32x76	86
194557	2400	92	S4	Za unutarnju cijev	70	32x76	86
194558	2400	102	S5	Za vanjsku cijev	70	32x76	86
194938	2500	106	S4	Za unutarnju cijev	70	36x89	100
194939	2500	112	S5	Za vanjsku cijev	70	36x89	100
195487	2600	130	S4	Za unutarnju cijev	70	42x104	120
196887	2600	130	S5	Za vanj. / unutar. cijev	70	42x104	120
197170	2600	130	S6	Za vanjsku cijev	90	42x104	120

VILICA CIJEVNA ZA DUPLI ZGLOB WALTERSCHEID STANDARD -RG-

18

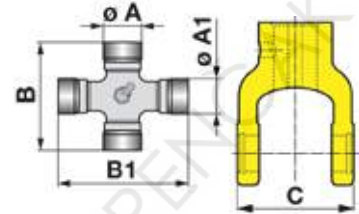
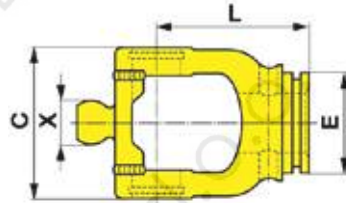

ŠIFRA	OZNAKA JAČINE	Dužina L mm	Profil cijevi	Opis	Promjer kugle X	Promjer E mm	Križ Ax B/A1x B1 mm	C mm
196022	2280	70	0a	Za vanjsku cijev	22	47	24x61 / 22x76	70
194716	2380	85	0v	Za unutarnju cijev	24	58	27x75 / 24x91	84
198857	2380	85	1	Za vanjsku cijev	24	58	27x75 / 24x91	84
194730	2480	92	1b	Za unutarnju cijev	27	70	32x76 / 27x94	86
194731	2480	92	2a	Za vanjsku cijev	27	70	32x76 / 27x94	86
197427	2480	92	S4	Za unutarnju cijev	27	70	32x76 / 27x94	86
197252	2480	92	S5	Za vanjsku cijev	27	70	32x76 / 27x94	86

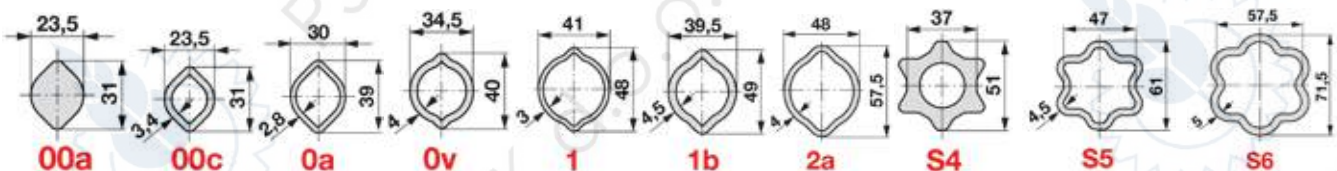



DUPLI ZGLOB WALTERSCHEID

SREDINA DUPLOG ZGLOBA WALTERSCHEID

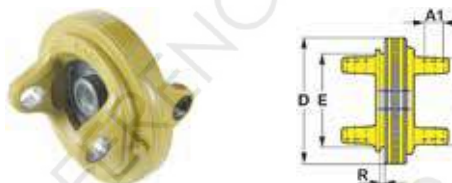
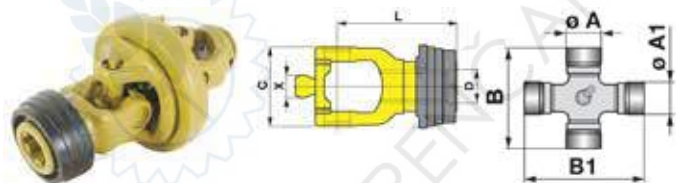

ŠIFRA	Jačina	Priključak	Oznaka sig. učvršćenja	Cijev	Križ
198859	2380	1 3/8" Z6	ASGE	1b	27x75 / 24x91
197357	2480	1 3/8" Z6	ASGE	1b	32x76 / 27x94
194728	2480	1 3/8" Z6	AG	2a	32x76 / 27x94
194729	2480	1 3/8" Z6	ASGE	S4	32x76 / 27x94
197251	2580	1 3/8" Z6	ASG	S4	36x89/32x106

ŠIFRA	Jačina	D mm	A1 mm	E mm	R mm
194516	2280	142	22	105	6
194517	2380	155	24	115	6
194518	2480	167	27	120	6
194519	2580	184	32	126	6

SKLOPKA SIGURNOSNA TARNA WALTERSCHEID

TARNA SKLOPKA K90



ŠIFRA	Opis	Oznaka jačine	Priključak vrat.	Jačina sklopke Nm	Tip sklopke	Pozicija na slici
PSC333298	Sklopka KOMPLET	2400	1 3/8" 6Z	900	K 90	-
PSC333267	Sklopka KOMPLET	2500	1 3/8" 6Z	800	K 90	-
PSC342368	Sklopka KOMPLET	2500	1 3/4" 6Z	1100	K 90	-
PSC338221	Srce sklopke	-	1 3/8" 6Z	-	K90	2
PSC338224	Srce sklopke	-	1 3/4" 6Z	-	K90	2
194556	Lamela sklopke	-	-	-	K90	3
PSC335443	Prirubnica sklopke	2300	-	-	K90	1
PSC335604	Prirubnica sklopke	2400	-	-	K90	1
PSC330592	Opruga	-	-	-	K90	8

TARNA SKLOPKA K90/4



ŠIFRA	Opis	Oznaka jačine	Priključak vrat.	Jačina sklopke Nm	Tip sklopke	Pozicija na slici
PSC333268	Sklopka KOMPLET	2500	1 3/8" 6Z	1500	K 90/4	-
198843	Sklopka KOMPLET	2500	1 3/4" 6Z	1500	K 90/4	-
PSC341881	Sklopka KOMPLET	2600	1 3/4" 6Z	1400	K 90/4	-
193408	Srce sklopke	-	1 3/8" 6Z	-	K 90/4	2
198858	Srce sklopke	-	1 3/4" 6Z	-	K 90/4	2
194556	Lamela sklopke	-	-	-	K 90/4	3
PSC335605	Prirubnica sklopke	2500	-	-	K 90/4	1
PSC335606	Prirubnica sklopke	2600	-	-	K 90/4	1
PSC330592	Opruga	-	-	-	K90/4	10



SKLOPKA SIGURNOSNA TARNA WALTERSCHEID

TARNA SKLOPKA K92

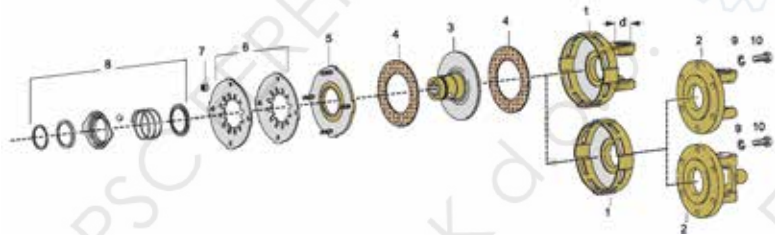
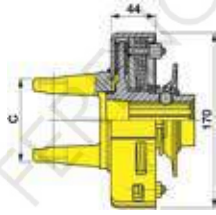

ŠIFRA	Opis	Oznaka jačine	Priključak vrat.	Jačina sklopke Nm	Tip sklopke	Pozicija na slici
PSC056033	Sklopka KOMPLET	2200	1 3/8" 6Z	750	K 92	-
PSC317189	Sklopka KOMPLET	2300	1 3/8" 6Z	900	K 92	-
PSC321714	Sklopka KOMPLET	2400	1 3/8" 6Z	900	K 92	-
PSC051551	Srce sklopke	-	1 3/8" 6Z	-	K 92	3
PSC051552	Srce sklopke	-	1 3/8" 21Z	-	K 92	3
194556	Lamela sklopke	-	-	-	K 92	4
PSC041180	Kučište sklopke	2200	-	-	K 92	2
PSC185836	Kučište sklopke	2300	-	-	K 92	2
PSC321715	Kučište sklopke	2400	-	-	K92	2
PSC045560	Opruga zelena 200Nm	-	-	-	K 92	6
PSC043487	Opruga bijela 300Nm	-	-	-	K 92	6
PSC043489	Opruga crvena 450Nm	-	-	-	K 92	6
PSC110063	Opruga plava 550Nm	-	-	-	K 92	6

TARNA SKLOPKA K92/4

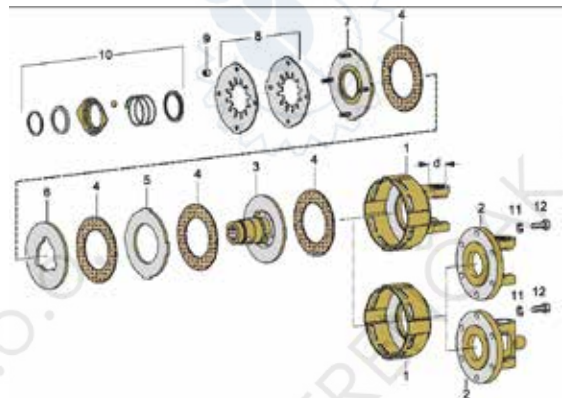
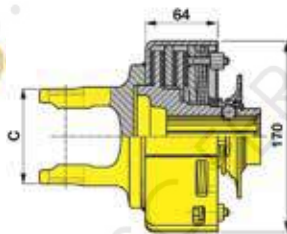

ŠIFRA	Opis	Oznaka jačine	Priključak vrat.	Jačina sklopke Nm	Tip sklopke	Pozicija na slici
PSC318851	Sklopka KOMPLET	2300	1 3/8" 6Z	1050	K 92/4	-
PSC321166	Sklopka KOMPLET	2400	1 3/8" 6Z	1350	K 92/4	-
PSC351045	Sklopka KOMPLET	2500	1 3/8" 6Z	1500	K 92/4	-
195734	Sklopka KOMPLET	2500	1 3/8" 6Z	1350	K 92/4	-
PSC051554	Srce sklopke	-	1 3/8" 6Z	-	K 92/4	3
195731	Srce sklopke	-	1 3/8" 21Z	-	K 92/4	3
194556	Lamela sklopke	-	-	-	K 92/4	4

ŠIFRA NAZIV

Set osigurača ZV

194510 1 3/8"



ŠIFRA NAZIV

Set osigurača KB

198842 1 3/8"
198482 1 3/4"





SKLOPKA SIGURNOSNA TARNA WALTERSCHEID

TARNA SKLOPKA K96 - K96/4



K96

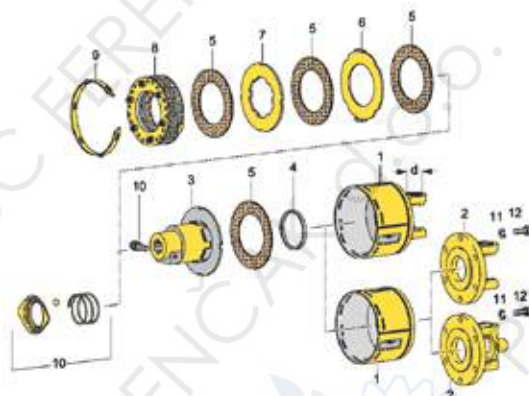
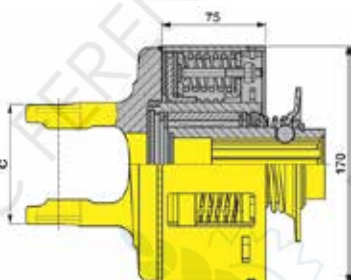

ŠIFRA	Opis	Oznaka jačine	Priključak vrat.	Jačina sklopke Nm	Tip sklopke	Pozicija na slici
PSC172237	Sklopka KOMPLET	2300	1 3/8" 6Z	1050	K 96	-
PSC112476	Sklopka KOMPLET	2300	1 3/8" 6Z	1300	K 96	-
PSC178217	Sklopka KOMPLET	2400	1 3/8" 6Z	900	K 96	-
PSC367757	Srce sklopke	-	1 3/8" 6Z	-	K 96	3
194554	Lamela sklopke	-	-	-	K 96	5
194546	Prsten	-	-	-	K96,K96/4	4
194520	Prsten	-	-	-	K96,K96/4	9
194547	Potisna ploča	-	-	-	K96/4	7
194548	Potisna ploča	-	-	-	K96/4	6

TARNA SKLOPKA K64/1 - K64/2 - K64/22



K64/1

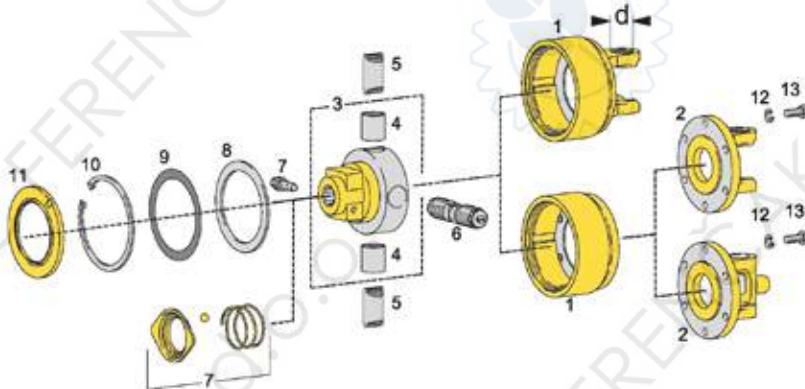

ŠIFRA	Opis	Oznaka jačine	Priključak vrat.	Jačina Nm	Tip sklopke	Pozicija na slici
194562	Sklopka desna KPL	2400	1 3/8" 6Z	1700	K64/2	-
194926	Sklopka desna KPL	2500	1 3/4" 6Z	2000	K64/2	-
196523	Zub sklopke	-	-	-	K64/2	5
197017	Zub sklopke	-	-	-	K64/22	5
196524	Opruga sklopke	-	-	1600	K64/2	6
194922	Opruga sklopke	-	-	2400	K64/2	6

ŠIFRA NAZIV

197021 Opruga sklopke
K64/24 3800 Nm





SKLOPKA SIGURNOSNA KB61/20 - KB61/30

ŠIFRA	OZNAKA JAČINE	Jačina sklopke Nm	Priključak vratila	Oznaka sig. učvršćenja	Promjer D mm	Promjer vijka	Križ Ax B mm
198844	2400	1600	1 3/8" 6Z	AG	156	M8	32x76
198845	2400	1600	1 3/4" 6Z	KF	156	M8	32x76
199778	2500	3330	1 3/4" 6Z	KF	156	M10	36x89
199777	2500	4800	1 3/4" 20Z	KF	156	M12	36x89
198002	2600	3900	1 3/4" 6Z	CC	160	M10	42x104
197605	2600	3900	1 3/4" 20Z	CC	160	M10	42x104



SKLOPKA SIGURNOSNA K31B DO K36B

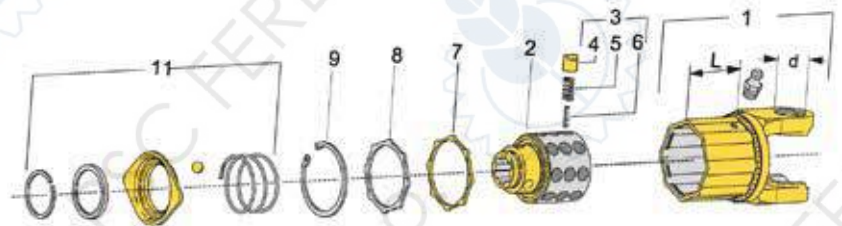

ŠIFRA	Opis	Oznaka jačine	Priključak vrat.	Jačina sklopke Nm	Tip sklopke	Križ mm	Pozicija na slici
PSC358570	Sklopka KPL	2300	1 3/8" 6Z	900	K33B	27x75	-
PSC364628	Sklopka KPL	2300	1 3/8" 6Z	1200	K34B	27x75	-
PSC362493	Sklopka KPL	2400	1 3/8" 6Z	900	K33B	32x76	-
194234	Distanca	-	-	-	-	-	-
194233	Prsten	-	-	-	-	-	8
194508	Zub sklopke KPL standard	-	-	-	-	-	3
194509	Zub sklopke KPL mekša verzija	-	-	-	-	-	3
194510	Set osigurača	-	-	-	-	-	11

18

ŠIFRA	NAZIV		ŠIFRA	NAZIV	
198237	Plastika zaštitna duplog zgloba		197254	Plastika zaštitna duplog zgloba	
197255	Plastika zaštitna duplog zgloba		199379	Plastika zaštitna duplog zgloba	
194717	Plastika zaštitna duplog zgloba		198860	Plastika zaštitna duplog zgloba	
194718	Prsten zaštitne plastike		198854	Prsten zaštitne plastike	
198004	115x166 mm 120x177 mm		198855	SD25	



SKLOPKA PROTOČNA F5/1 - F5/2

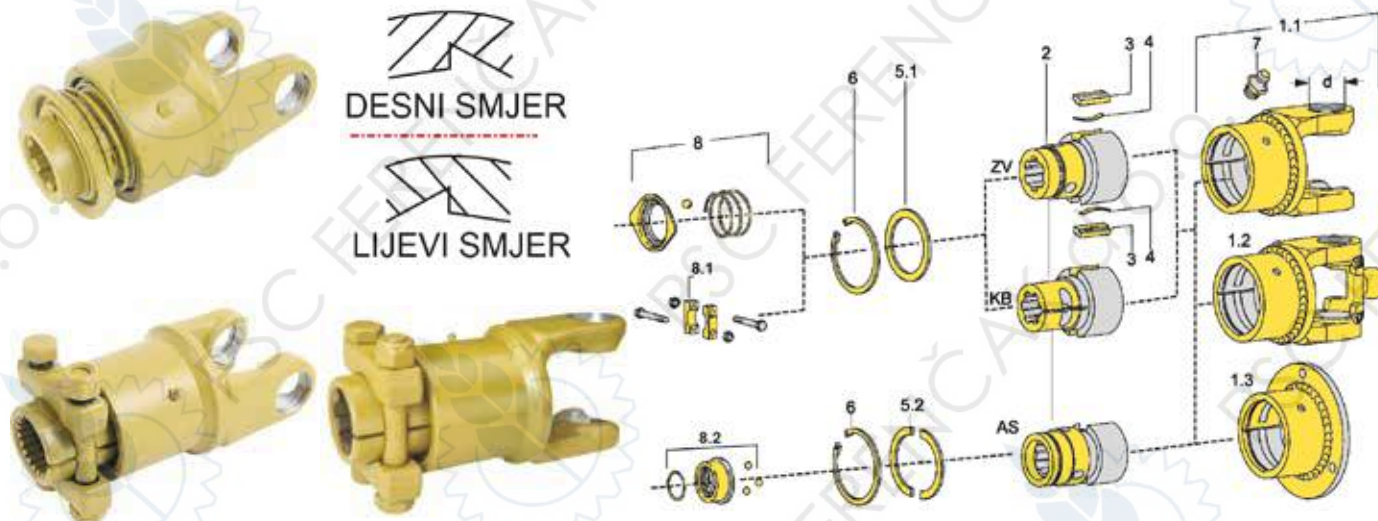

ŠIFRA	Opis	Oznaka jačine	Priključak vrat.	Oznaka sig. učvršćenja	Tip sklopke	Križ mm	Pozicija na slici
194734	Sklopka desna KPL	2400	1 3/8" 6Z	ZV	F5/1R	32x76	-
194735	Sklopka desna KPL	2400	1 3/8" 6Z	KB	F5/2R	36x89	-
194732	Sklopka desna KPL	2500	1 3/8" 6Z	ZV	F5/2R	36x89	-
194733	Sklopka desna KPL	2500	1 3/8" 6Z	KB	F5/2R	36x89	-
194875	Sklopka lijeva KPL	2500	1 3/8" 6Z	ZV	F5/2L	36x89	-
194876	Sklopka lijeva KPL	2500	1 3/8" 6Z	KB	F5/2L	36x89	-
196614	Sklopka desna KPL	2600	1 3/8" 6Z	KB	F5/2R	42x104	-
197593	Sklopka desna KPL	2600	1 3/4" 6Z	CC	F5/2R	42x104	-
196112	Sklopka desna KPL	2600	1 3/4" 20Z	CC	F5/2R	42x104	-
194534	Zub sklopke	-	-	-	F5/1	-	3
198848	Opruga zuba sklopke	-	-	-	F5/1	-	4
198806	Distanca 56x72	-	-	-	F5/1; F5/2	-	5.1
194535	Zub sklopke	-	-	-	F5/2	-	3
194512	Opruga zuba sklopke	-	-	-	F5/2	-	4
198849	Distanca 60x72	-	-	-	F5/2	-	5.1
198804	Srce sklopke	-	1 3/4" 20Z	KB	F5/1	-	-
198847	Srce sklopke	-	1 3/4" 6Z	KB	F5/2	-	-
196228	Srce sklopke	-	1 3/4" 20Z	KB	F5/2	-	-

SRCE SKLOPKE F5/1

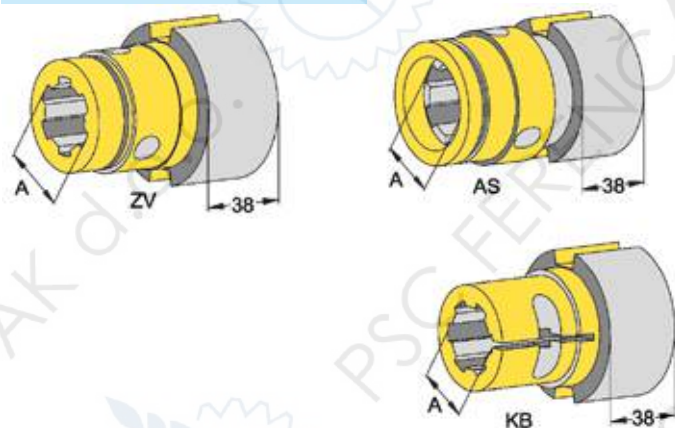

SRCE SKLOPKE F5/2

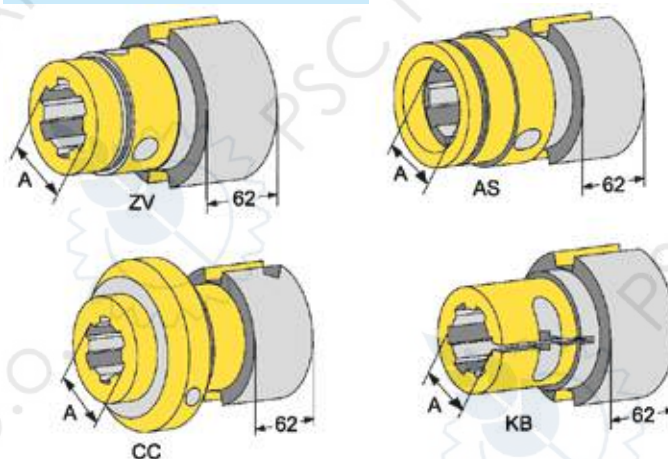



IDENTIFIKACIJA KARDANSKIH ZGLOBOVA

CERJAK

PRIKLJUČAK



KATEGORIJA	KARDANSKI KRIŽ	VANJSKA CIJEV	UNUTARNJA CIJEV
1			
2			
3			
4			
5			
6			
8			



KARDANI

CERJAK

BEZ SKLOPKE

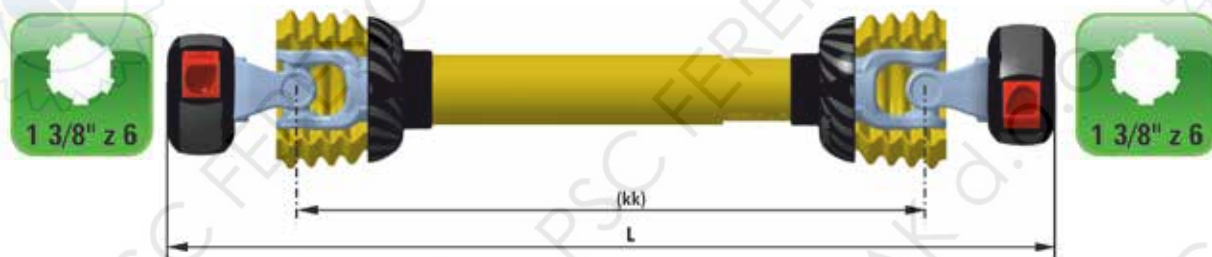

ŠIFRA	KATEGORIJA	NAZIV	NAMJENA	KRIŽ mm	DUŽINA kk (mm)	Dužina L (mm)
020001	1	Kardan S1	Prskalica, okretač i sl.	22x55	610	800
	1	Kardan S1	Pneumatska sijačica i sl.	22x55	910	1100
020051	4	Kardan S4	Vitlo do 3T, cisterna do 5000L	27x74,6	630	860
	4	Kardan S4	Cisterna od 5000L, kopač i sl.	27x74,6	880	1110
020008	6	Kardan S6	Vitlo 4-6T, cjepač drva	30,2x91,4	660	910
	6	Kardan S6	Balirka (okrugle bale)	30,2x91,4	1010	1260

S PROTOČNOM SKLOPKOM

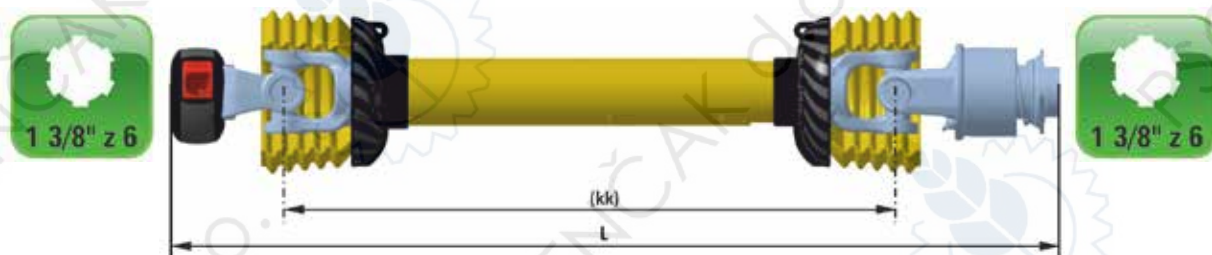

ŠIFRA	KATEGORIJA	NAZIV	NAMJENA	KRIŽ mm	DUŽINA kk (mm)	Dužina L (mm)
020004	4	Kardan S4 PS	Roto kosa do 1,65m	27x74,6	630	910
	4	Kardan S4 PS Lijeva sklopka	Prednja roto kosa	27x74,6	630	910
020010	6	Kardan S6 PS	Roto kosa do 2,2m Silokombajn 1 red	30,2x91,4	660	950

SA SIGURNOSNOM SKLOPKOM

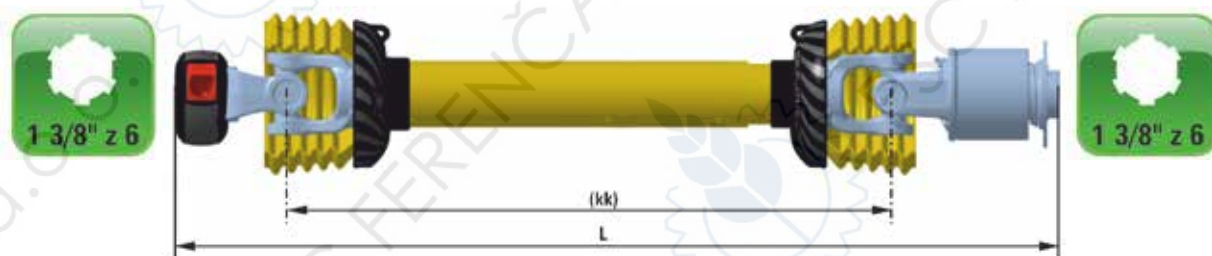

ŠIFRA	KATEGORIJA	NAZIV	NAMJENA	KRIŽ mm	DUŽINA kk (mm)	Dužina L (mm)
020003	4	Kardan S4 600Nm	Jednoredni berač, okretač samoutovarna prikolica	27x74,6	880	1150
020056	4	Kardan S4 900Nm	Prikolica za gnoj 4-6T	27x74,6	960	1250



KARDANI

CERJAK

SA SIGURNOSNOM SKLOPKOM NA VIJAK

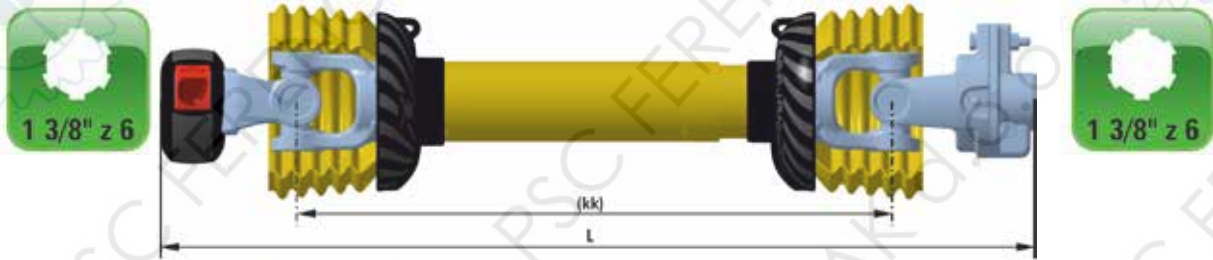

ŠIFRA	KATEGORIJA	NAZIV	NAMJENA	KRIŽ mm	DUŽINA kk (mm)	Dužina L (mm)
	4	Kardan S4 900Nm	Freza do 1,6 m	27x74,6	630	860
197662	6	Kardan S6 2700Nm	Roto brana 2-2,5 m	30,2x91,4	660	910
197663	8	Kardan S8 3000Nm	Roto brana 2,5-3 m	35x106	660	910

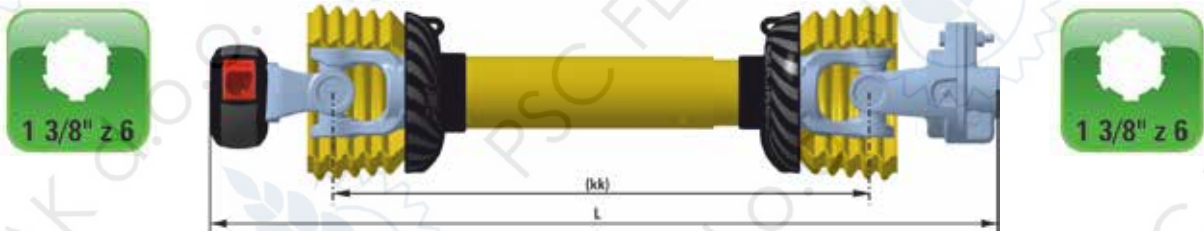

ŠIFRA	KATEGORIJA	NAZIV	NAMJENA	KRIŽ mm	DUŽINA kk (mm)	Dužina L (mm)
198629	8	Kardan S8 3000Nm	Roto brana 2,5-3 m	35x106	660	910

S TARNOM SKLOPKOM

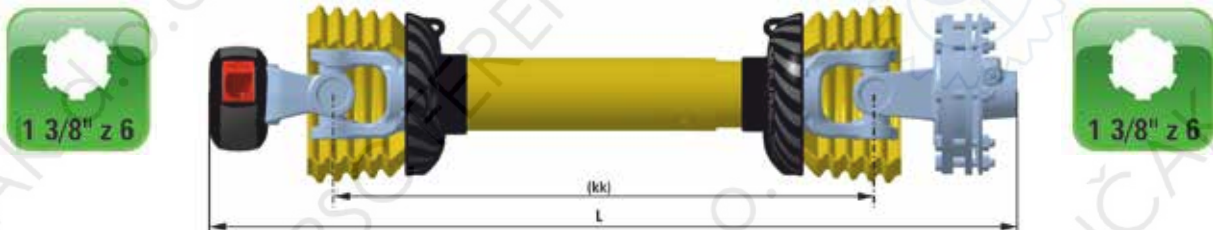

ŠIFRA	KATEGORIJA	NAZIV	NAMJENA	KRIŽ mm	DUŽINA kk (mm)	Dužina L (mm)
	4	Kardan S4 TS 800Nm	Freza do 1,6 m	27x74,6	630	890
020005	6	Kardan S6 TS 1200Nm	Roto brana 2-2,5 m	30,2x91,4	660	950
199317	6	Kardan S6 TS 1200Nm	Roto brana 2-2,5 m	30,2x91,4	1010	1280

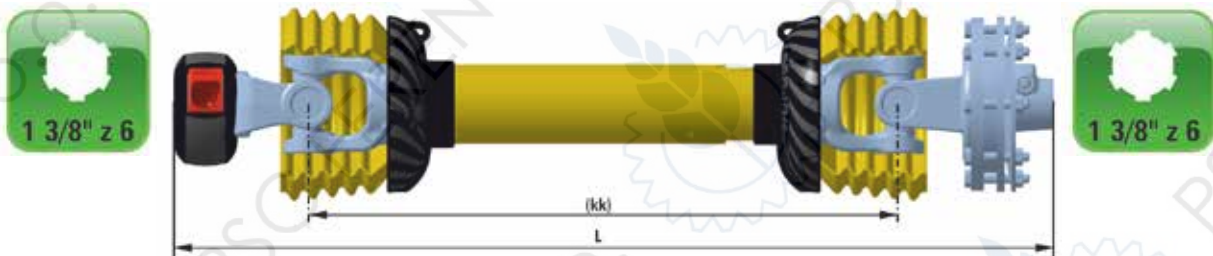

ŠIFRA	KATEGORIJA	NAZIV	NAMJENA	KRIŽ mm	DUŽINA kk (mm)	Dužina L (mm)
193455	8	Kardan S8 TS 1800Nm	Roto brana 2,5-3 m	35x106	660	950

18



KARDANI CERJAK

SA DUPLIM ZGLOBOM



ŠIFRA	KATEGORIJA	NAZIV	NAMJENA	KRIŽ mm	DUŽINA kk (mm)	Dužina L (mm)
020059	4	Kardan S4 DZ	Mješač gnojnice, cisterna do 10000L, atomizer	27x74,6	880	1200
020047	4	Kardan S4 DZ 600Nm	Samoutovarna prikolica jednoreadni berač	27x74,6	880	1240
193911	4	Kardan S4 DZ 900Nm	Dvoredni berač	27x74,6	880	1260

ZAŠTITA KARDANA C-line CERJAK

ŠIFRA	NAZIV
203180	Zaštita kardana C-line 1kk 560
202765	Zaštita kardana C-line 1kk 1210
201728	Zaštita kardana C-line 4 1110
201729	Zaštita kardana C-line 4 1130
202019	Zaštita kardana C-line 6



KRIŽEVI KARDANA CERJAK

ŠIFRA	KATEGORIJA	DIMENZIJE AxB mm	C mm
190513	-	18x47	-
020018	1	22x55	63
020041	2	24x61	70
020019	3	27x70	79
020020	4	27x75	84
020021	6	30,2x92	103
020022	6	32x76	85
020055	8	35x106	117

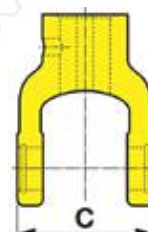
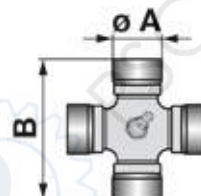



KRIŽEVI KARDANA AMA TALIJANSKI

ŠIFRA	DIMENZIJE AxB mm	C mm
192375	20x44	
191922	22x54	63
191923	23,8x61,2	70
191924	27x70	79
191925	27x75	84
191391	27x82	-
191926	29x80	-
191927	30,2x80	91
191928	30,2x106,5	-
192663	30,9x92	-
195042	32x76	85
192380	34x90	-
193067	34x106,5	-
195041	35x94	106
194178	35x97	-
190512	35x106,5	117
193614	36x89	-
190511	41x108	119
197371	41x118	130,5

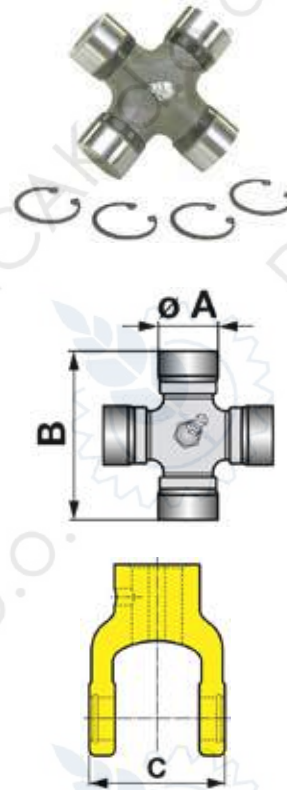

CIJEVI KARDANA CERJAK

18

ŠIFRA	NAZIV	ŠIFRA	NAZIV
020012	Cijev kardana 01 <i>Cijevi se prodaju u paru!</i>	020015	Cijev kardana 06 <i>Cijevi se prodaju u paru!</i>
020013	Cijev kardana 04 <i>Cijevi se prodaju u paru!</i>	197165	Cijev kardana 08 <i>Cijevi se prodaju u paru!</i>
020012	Cijev 01 limun 21 Cerjak <i>Cijevi se prodaju u paru!</i>	201214	Cijev 04 limun W23 Cerjak <i>Cijevi se prodaju u paru!</i>
		190644	Cijev 24 (08 W limun) Cerjak <i>Cijevi se prodaju u paru!</i>

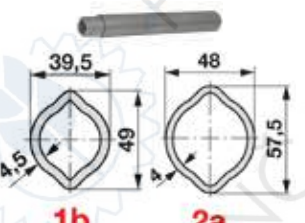
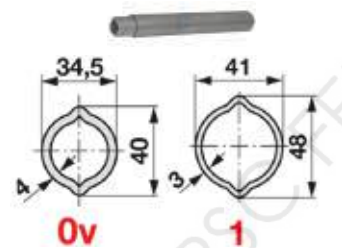
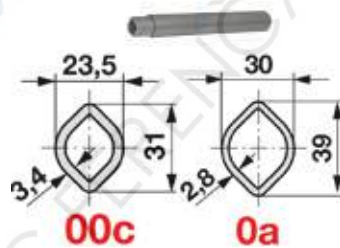



CIJEVI KARDANA TALIJANSKE

ŠIFRA	NAZIV	ŠIFRA	NAZIV
195046	Cijev kardana 01 talijanska unutarnja	197902	Cijev kardana 08 talijanska unutarnja
195047	Cijev kardana 01 talijanska vanjska <i>Cijevi se prodaju pojedinačno!</i>		
196451	Cijev kardana 02 talijanska unutarnja	195050	Cijev kardana 06 talijanska unutarnja
196287	Cijev kardana 02 talijanska vanjska <i>Cijevi se prodaju pojedinačno!</i>	195051	Cijev kardana 06 talijanska vanjska <i>Cijevi se prodaju pojedinačno!</i>
195048	Cijev kardana 04 talijanska unutarnja	196452	Cijev kardana 08 talijanska unutarnja
195049	Cijev kardana 04 talijanska vanjska <i>Cijevi se prodaju pojedinačno!</i>	197367	Cijev kardana 08 talijanska vanjska <i>Cijevi se prodaju pojedinačno!</i>
199500	Cijev kardana S6 talijanska unutarnja		
199501	Cijev kardana S6 talijanska vanjska <i>Cijevi se prodaju pojedinačno!</i>		

VILICE PRIKLJUČNE CERJAK

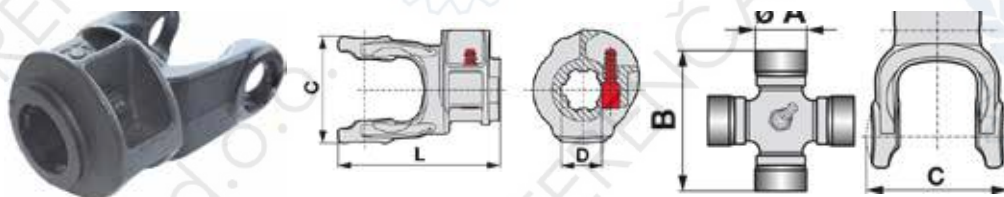

ŠIFRA	KATEGORIJA	promjer D mm	Križ AxB mm	C mm
020028	1	34,9	22x55	57
195316	2	34,9	24x61	
020042	3	34,9	27x70	
020030	4	34,9	27x75	77,4
190797	6	34,9	30,2x91,4	103
020043	-	34,9	32x76	
193141	-	34,9	34x90	
192698	-	34,9	35x94	
190564(192950)	8	34,9	35x106	117

18



ŠIFRA	Kategorija	Priključak	AxB mm	C mm	ŠIFRA	Kategorija	Priključak	AxB mm	C mm
196453	4	1 3/8" Z21	27x75	84	020067	6	1 3/4" Z6	30,2x91,4	103
197728	6	1 3/8" Z21	30,2x91,4	103	193536	6	1 3/4" Z20	30,2x91,4	103
192951	8	1 3/8" Z21	35x106	117	192949	8	1 3/4" Z6	35x106	117
					196974	8	1 3/4" Z20	35x106	117



VILICE CIJEVNE

CERJAK

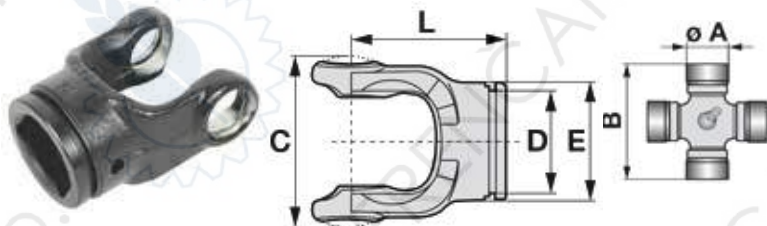

ŠIFRA	KATEGORIJA Cijevi	Cijev	Križ AxB mm	C mm
198617	1	Za unutarnju cijev	22x55	63
198618	1	Za vanjsku cijev	22x55	63
191380U	2	Za unutarnju cijev	24x61	70
191380V	2	Za vanjsku cijev	24x61	70
020032	3	Za unutarnju cijev	27x70	79
198619	3	Za vanjsku cijev	27x70	79
198622	4	Za unutarnju cijev	27x75	84
198621	4	Za vanjsku cijev	27x75	84
195039U	4	Za unutarnju cijev	29x80	-
195039V	4	Za vanjsku cijev	29x80	-
196126U	5	Za unutarnju cijev	30,2x80	91
196126V	5	Za vanjsku cijev	30,2x80	91
020066	6	Za unutarnju cijev	30,2x91,4	103
020033	6	Za vanjsku cijev	30,2x91,4	103
195827U	6	Za unutarnju cijev	35x94	105
195827V	6	Za vanjsku cijev	35x94	105
198625	6	Za unutarnju cijev	35x106	117
198624	6	Za vanjsku cijev	35x106	117
192952U	8	Za unutarnju cijev	35x106	117
192952V	8	Za vanjsku cijev	35x106	117

ŠIFRA	NAZIV	
020027 194699 195043	Štift kardana L=75 mm, D=13 mm L=75 mm, D=14 mm L=95 mm, D=16 mm	
197905 198740	Štift kardana L=47 mm, D=14 mm L=60 mm, D=16 mm	
193612 196608 196376	Lamela tarne sklopke A=140 mm, B=85 mm A=140 mm, B=85 mm A=140 mm, B=85 mm Debljina svih lamela je 3,2 mm	
100041 198050 193381	Mast FUCS Renolit BFX 400 g 1/1 kg 5/1 kg	

SKLOPKA SIGURNOSNA

18

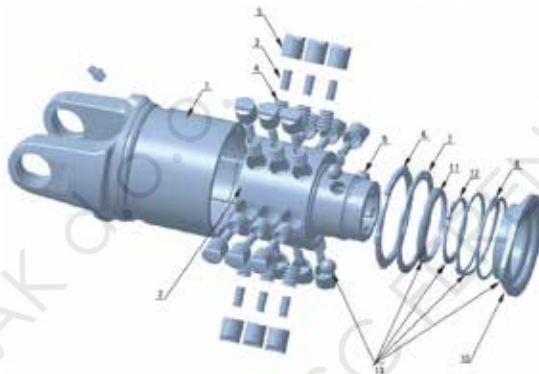

ŠIFRA	Opis	Kategorija	Priključak vrat.	Jačina sklopke Nm	Tip sklopke	Križ mm	Pozicija na slici
191379	Sklopka KPL	2	1 3/8" Z 6	600	VS	24x61	-
020038	Sklopka KPL	4	1 3/8" Z 6	600	VS	27x75	-
020046	Sklopka KPL	4	1 3/8" Z 6	900	VS	27x75	-
020065	Opruga unutarnja	-	-	-	VS	-	3
020064	Opruga vanjska	-	-	-	VS	-	4
020063	Zub sklopke	-	-	-	VS	-	5
196271	Obruč zatvarača	-	-	-	Vs	-	6
193294	Opruga	-	-	-	VS	-	8
193297	Kuglica	-	-	-	VS	-	9
193292	Ploča priključna	-	-	-	VS	-	10
193296	Obruč kutni	-	-	-	VS	-	11



SKLOPKA PROTOČNA

CERJAK

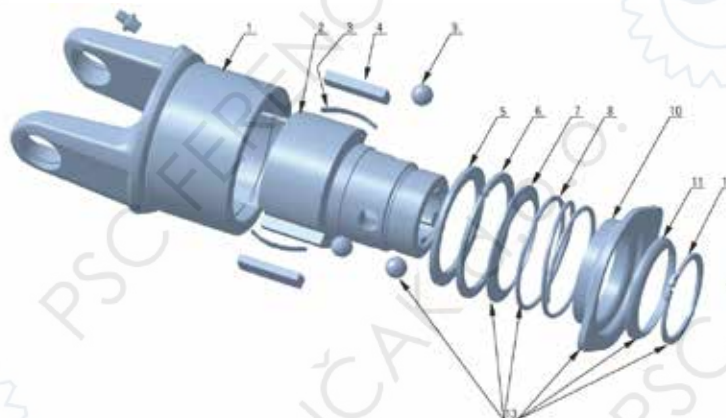

ŠIFRA	Opis	Kategorija	Priključak vrat.	Tip sklopke	Križ mm	Pozicija na slici
194837	Sklopka desna KPL	3	1 3/8" Z 6	PS/R	27x70	-
020045	Sklopka desna KPL	4	1 3/8" Z 6	PS/R	27x75	-
193682	Sklopka lijeva KPL	4	1 3/8" Z 6	PS/L	27x75	-
020070	Sklopka desna KPL	6	1 3/8" Z 6	PS/R	30,2x91,4	-
190580	Sklopka desna KPL	6	1 3/8" Z 6	PS/R	32x76	-
198416	Sklopka desna KPL	8	1 3/8" Z 6	PS/R	35x106	-
020062	Opruga	-	-	PS	-	3
190228	Zub sklopke	-	-	PS	-	4
193292	Distanca	-	-	PS	-	5
193293	Zaštitni prsten	-	-	PS	-	7
193294	Opruga	-	-	PS	-	8
193297	Kuglica	-	-	PS	-	9
193292	Ploča priključna	-	-	PS	-	10
193296	Obruč kutni	-	-	PS	-	11

SKLOPKA TARNA

CERJAK

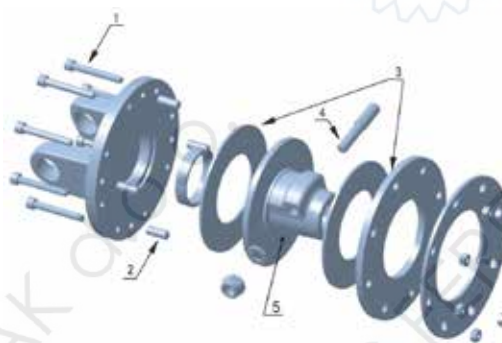

18

ŠIFRA	Opis	Kategorija	Priključak vrat.	Tip sklopke	Križ mm	Pozicija na slici
020069	Sklopka KPL	6	1 3/8" Z 6	TS	30,2x91,4	-
020061	Sklopka KPL	8	1 3/8" Z 6	TS	35x105	-
195319	Srce sklopke	-	1 3/8" Z 6	-	-	5
195318	Srce sklopke	-	1 3/8" Z 6	-	-	5

SKLOPKA SIGURNOSNA NA VIJAK

CERJAK

ŠIFRA	Kategorija	Jačina sklopke Nm	Priključak vratila	Tip sklopke	Križ Ax B mm
199118	6	2700	1 3/8" Z 6	ST	30,2x91,4
199115	8	3000	1 3/4" Z 6	ST	35x106





KARDANSKE REDUKCIJE

CERJAK

ŠIFRA	NAZIV	ŠIFRA	NAZIV
198739	Redukcija 1 3/4" Z6 unutarnji na 1 3/8" Z6 vanjski	198891	Redukcija Ø30 unutarnji na 1 3/8" Z6 vanjski
198542	Redukcija 1 1/8" Z6 unutarnji na 1 3/8" Z6 vanjski	195199	Nastavak kardanski 1 3/8" Z6 L=100 mm
192376	Redukcija 1 3/8" Z6 unutarnji na 1 3/8" Z6 vanjski	196798	Nastavak kardanski 1 3/8" Z6 L=150 mm
196730	Redukcija 1 3/4" Z20 unutarnji na 1 3/8" Z6 vanjski	199499	Nastavak kardanski 1 3/4" Z6 L=100 mm
195821	Redukcija 1 3/8" Z21 unutarnji na 1 3/8" Z6 vanjski	199588	Nastavak kardanski 1 3/4" Z6 L=130 mm
198738	Osovina kardanska sirova 1 3/8" Z6 L=400 mm		

SERVIS KARDANA

SERVIS KARDANA U KRIŽEVCIMA I OSIJEKU!



Zamjena kardanskih priključaka (vilica).



Rezanje cijevi po mjeri.



Zamjena kardanskih križeva.



Zamjena i montaža plastične zaštite.



Od sada možete Vaše kardane osim u Križevcima, servisirati i popravljati u našem poljoprivredno-servisnom centru Osijeku.

Vršimo:

- montažu, demontažu i zamjenu kardanskih vilica
- montažu, demontažu i prodaju kardanskih križeva
- skraćivanje kardanskih cijevi po mjeri
- prodaju kardanskih cijevi po mjeri
- montažu, demontažu i prodaju zaštitne plastike za kardane.

Koristimo i ugrađujemo najkvalitetnije originalne ili zamjenske dijelove.

Servis i popravak kardana možete izvršiti na adresama:

PSC Ferencak KRIŽEVCI
Nikole Tesle 12
tel. 048 681 902
fax. 048 682 903

PSC Ferencak OSIJEK
Livana, Omladinska 128
tel. 031 211 902
fax. 031 211 902

Upite i narudžbe možete poslati na adresu
info@psc-ferencak.hr



Prostor za bilješke

A large grid area for notes, overlaid with a large, faint watermark of the PSC FERENČAK logo and the text "PSC FERENČAK d.o.o." repeated diagonally across the page.

PSC ferencak

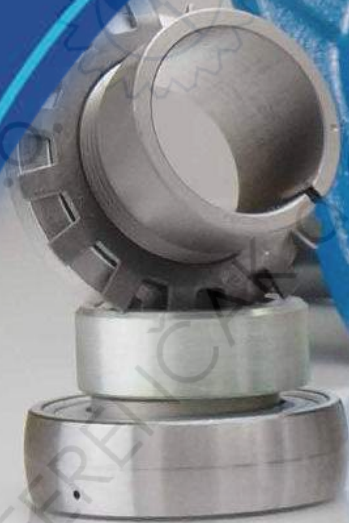
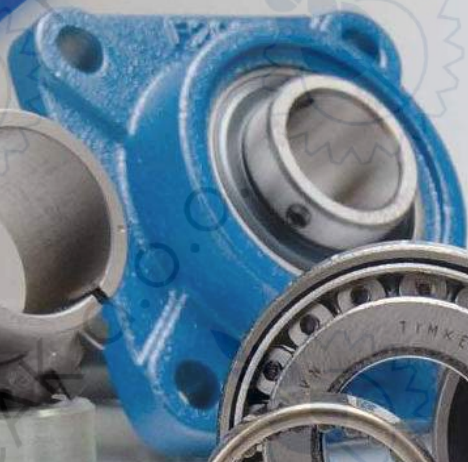

PSC FERENČAK d.o.o.

**LEŽAJEVI**

KUGLIČNI LEŽAJEVI ZZ	250
KUGLIČNI LEŽAJEVI 2RS C3	251
KUGLIČNI LEŽAJEVI AKSIJALNI	252
KUGLIČNI LEŽAJEVI PRILAGODLJIVI	252
KONUSNO-VALJKASTI LEŽAJEVI	253
KUGLIČNI LEŽAJEVI S KUĆIŠTEM	254
KUGLIČNI LEŽAJEVI ZA KUĆIŠTA	255
KUGLIČNO-BAČVASTI LEŽAJEVI	255
ULJNA BRTVILA (SEMERINZI)	256
SPREJEVI	256





KUGLIČNI LEŽAJEVI

JEDNOREDNI KUGLIČNI LEŽAJEVI

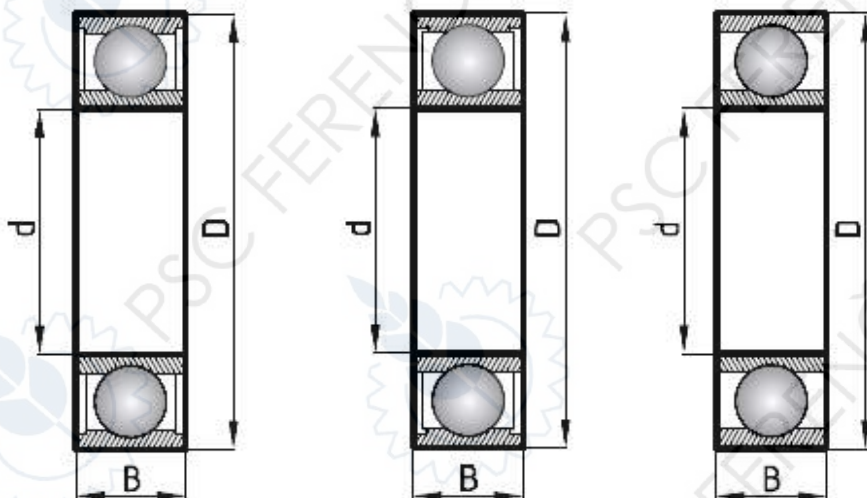

Z - kuglice pokrivena sa metalnom zaštitom s jedne strane

ZZ - kuglice pokrivena sa metalnom zaštitom s obje strane

MODEL 60

ŠIFRA	OZNAKA	d (mm)	D (mm)	B (mm)
190105	6000 ZZ	10	26	8
190106	6001 ZZ	12	28	8
198903	6002 ZZ	15	32	9
198904	6003 ZZ	17	35	10
198905	6004 ZZ	20	42	12
198911	6005 ZZ	25	47	12
198906	6006 ZZ	30	55	13

ŠIFRA	OZNAKA	d (mm)	D (mm)	B (mm)
198907	6007 ZZ	35	62	14
198912	6008 ZZ	40	68	15
198913	6009 ZZ	45	75	16
198908	6010 ZZ	50	80	16
198910	6011 ZZ	55	90	18
198909	6012 ZZ	60	95	18

MODEL 62

ŠIFRA	OZNAKA	d (mm)	D (mm)	B (mm)
198914	6200 ZZ	10	30	9
198915	6201 ZZ	12	32	10
198916	6202 ZZ	15	35	11
198917	6203 ZZ	17	40	12
198918	6204 ZZ	20	47	14
198919	6205 ZZ	25	52	15
198920	6206 ZZ	30	62	16

ŠIFRA	OZNAKA	d (mm)	D (mm)	B (mm)
198921	6207 ZZ	35	72	17
198922	6208 ZZ	40	80	18
198923	6209 ZZ	45	85	19
198924	6210 ZZ	50	90	20
190089	6211 ZZ	55	100	21
198925	6212 ZZ	60	110	22

MODEL 63

ŠIFRA	OZNAKA	d (mm)	D (mm)	B (mm)
198926	6300 ZZ	10	35	11
199262	6301 ZZ	12	37	12
199263	6302 ZZ	15	42	13
199284	6303 ZZ	17	47	14
198927	6304 ZZ	20	52	15
198928	6305 ZZ	25	62	17
198929	6306 ZZ	30	72	19

ŠIFRA	OZNAKA	d (mm)	D (mm)	B (mm)
198930	6307 ZZ	35	80	21
198931	6308 ZZ	40	90	23
198932	6309 ZZ	45	100	25



KUGLIČNI LEŽAJEVI

JEDNOREDNI KUGLIČNI LEŽAJEVI

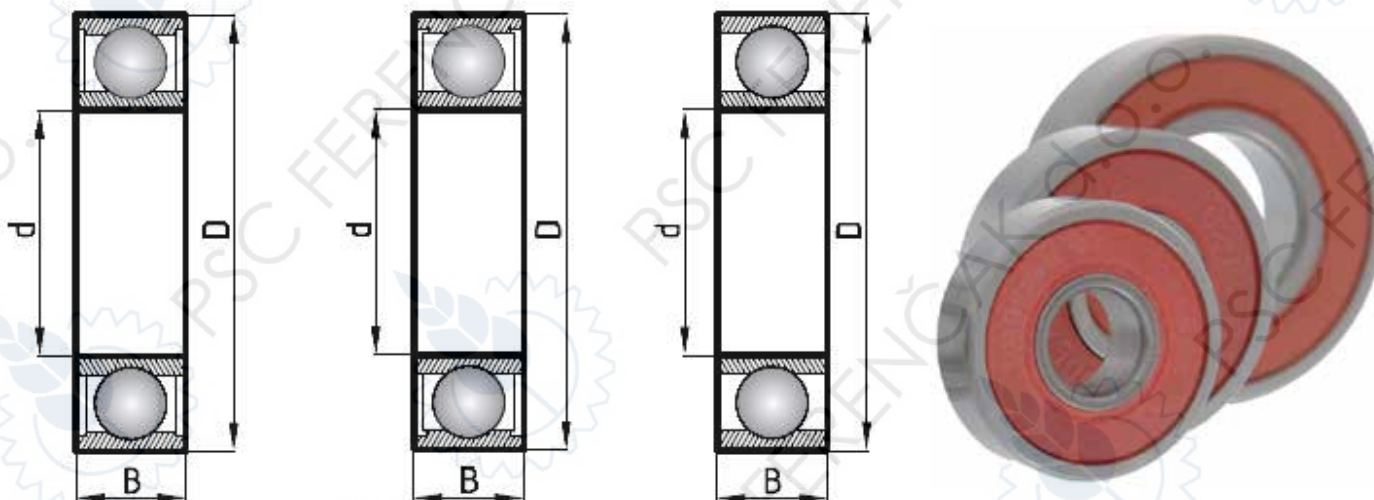

MODEL 60

ŠIFRA	OZNAKA	d (mm)	D (mm)	B (mm)
191146	6000 2RS C3	10	26	8
191150	6001 2RS C3	12	28	8
190107	6002 2RS C3	15	32	9
190111	6003 2RS C3	17	35	10
198966	6004 2RS C3	20	42	12
198967	6005 2RS C3	25	47	12
198968	6006 2RS C3	30	55	13

RS - zaptivni prsten od umjetnog kaučuka ojačan limom na jednoj strani

ŠIFRA	OZNAKA	d (mm)	D (mm)	B (mm)
198969	6007 2RS C3	35	62	14
198970	6008 2RS C3	40	68	15
199971	6009 2RS C3	45	75	16
198972	6010 2RS C3	50	80	16

MODEL 62

ŠIFRA	OZNAKA	d (mm)	D (mm)	B (mm)
190779	6200 2RS C3	10	30	9
191181	6201 2RS C3	12	32	10
190098	6202 2RS C3	15	35	11
190778	6203 2RS C3	17	40	12
198974	6204 2RS C3	20	47	14
198975	6205 2RS C3	25	52	15
198976	6206 2RS C3	30	62	16

2RS - zaptivni prsten od umjetnog kaučuka ojačan limom na obje strane

ŠIFRA	OZNAKA	d (mm)	D (mm)	B (mm)
198977	6207 2RS C3	35	72	17
198978	6208 2RS C3	40	80	18
198979	6209 2RS C3	45	85	19
198980	6210 2RS C3	50	90	20
198981	6211 2RS C3	55	100	21
198982	6212 2RS C3	60	110	22

MODEL 63

ŠIFRA	OZNAKA	d (mm)	D (mm)	B (mm)
191145	6300 2RS C3	10	35	11
191623	6301 2RS C3	12	37	12
191144	6302 2RS C3	15	42	13
190782	6303 2RS C3	17	47	14
190117	6304 2RS C3	20	52	15
191143	6305 2RS C3	25	62	17
190118	6306 2RS C3	30	72	19

C3 - ležajeve odlikuje veća izdržljivost, pouzdanost, dulji životni vijek i veća točnost izrade. Podnose veći broj okretaja i imaju manje vibracije i šumnost.

ŠIFRA	OZNAKA	d (mm)	D (mm)	B (mm)
190784	6307 2RS C3	35	80	21
190783	6308 2RS C3	40	90	23
191190	6309 2RS C3	45	100	25
191141	6310 2RS C3	50	110	27



KUGLIČNI LEŽAJEVI

JEDNOSMJERNO DJELUJUĆI AKSIJALNI KUGLIČNI LEŽAJEVI

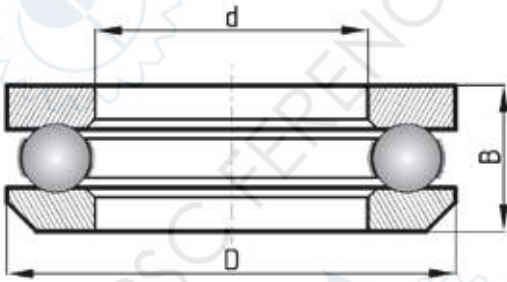

MODEL 511

ŠIFRA	OZNAKA	d (mm)	D (mm)	B (mm)
198956	51107	35	52	12
190126	51108	40	60	13
198957	51109	45	65	14
198958	51110	50	70	14

MODEL 512

ŠIFRA	OZNAKA	d (mm)	D (mm)	B (mm)
198960	51207	35	62	18
198961	51208	40	68	19
198962	51209	45	73	20
198963	51210	50	78	22

PRILAGODLJIVI KUGLIČNI LEŽAJEVI S PROŠIRENIM UNUTRAŠNJI OBRUČEM

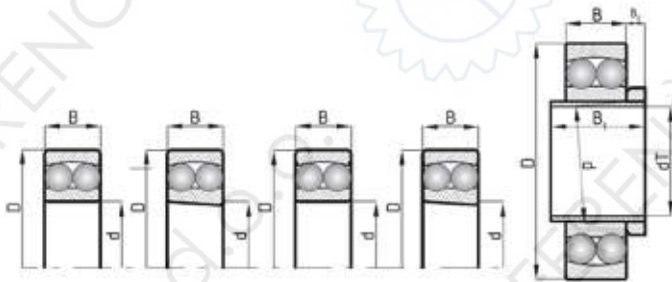

19

ŠIFRA	OZNAKA	d (mm)	D (mm)	B (mm)
198949	1205	25	52	15
199266	1206 K	30	62	16
199267	1207 K	35	72	17
198950	1209	45	85	19
198951	1210	50	90	20

ŠIFRA	OZNAKA	d (mm)	D (mm)	B (mm)
198952	1305	25	62	17
198953	1306	30	72	19
198954	1307	35	80	21
198955	1308	40	90	23





KONUSNO-VALJKASTI LEŽAJEVI

JEDNOREDNI KONUSNO-VALJKASTI LEŽAJEVI

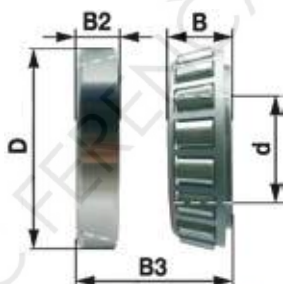

MODEL 512

ŠIFRA	OZNAKA	d (mm)	D (mm)	B (mm)	B2 (mm)	B3 (mm)
191195	30202	15	35	11	10	11,75
191194	30203	17	40	12	11	13,25
198934	30204	20	47	14	12	15,25
199563	30205	25	52	15	13	16,25
198935	30206	30	62	16	14	17,25
190254	30207	35	72	17	15	18,25
191193	30208	40	80	18	16	19,75
191196	30209	45	85	19	16	20,75
190094	30210	50	90	20	17	21,75
191197	30211	55	10	21	18	22,75

ŠIFRA	OZNAKA	d (mm)	D (mm)	B (mm)	B2 (mm)	B3 (mm)
-	30212	60	110	22	19	23,75
-	30213	65	120	23	20	24,75
-	30214	70	125	24	21	26,25
191198	30215	75	130	25	22	27,25
-	30216	80	140	26	22	28,25
-	30217	85	150	28	24	30,5
-	30218	90	160	30	26	32,5
-	30219	95	170	32	27	34,5
-	30220	100	180	34	29	37

MODEL 512

ŠIFRA	OZNAKA	d (mm)	D (mm)	B (mm)	B2 (mm)	B3 (mm)
198940	32004	20	42	15	12	15
198941	32005	25	47	15	11,5	15
191427	320/28	28	52	16	12	16
198942	32006	30	55	17	13	17
190081	320/32	32	58	17	13	17
191199	32007	35	62	18	14	18
190342	32008	40	68	19	14,5	19
198943	32009	45	75	20	15,5	20
198944	32010	50	80	20	15,5	20
19945	32011	55	90	23	17,5	23

ŠIFRA	OZNAKA	d (mm)	D (mm)	B (mm)	B2 (mm)	B3 (mm)
198946	32012	60	95	23	17,5	23
-	32013	65	100	23	17,5	23
-	32014	70	110	25	19	25
-	32015	75	115	25	19	25
-	32016	80	125	29	22	29
-	32017	85	130	29	22	29
-	32018	90	140	32	24	32
-	32019	95	145	32	24	32
-	32020	100	150	32	24	32

MODEL 512

ŠIFRA	OZNAKA	d (mm)	D (mm)	B (mm)	B2 (mm)	B3 (mm)
190125	32203	17	40	16	14	17,25
198947	32205	25	52	18	16	19,25
198948	32206	30	62	20	17	21,25
190201	32207	35	72	23	19	24,25
190085	32208	40	80	23	19	24,75
199264	32209	45	85	23	19	24,75
199265	32210	50	90	23	19	24,75
198983	32211	55	100	25	21	26,75
191200	32212	60	110	28	24	29,75

ŠIFRA	OZNAKA	d (mm)	D (mm)	B (mm)	B2 (mm)	B3 (mm)
-	32213	65	120	31	27	32,75
-	32214	70	125	31	27	33,25
-	32215	75	130	31	27	33,25
-	32216	80	140	33	28	35,25
-	32217	85	150	36	30	38,5
-	32218	90	160	40	34	42,5
-	32219	95	170	43	37	45,5
-	32220	100	180	46	39	49



KUGLIČNI LEŽAJEVI S KUĆIŠTEM



MODEL UCF 200

ŠIFRA	OZNAKA	d (mm)	L (mm)	LA (mm)	H (mm)	d2 (mm)
-	UCF 202	15	86	64	12	12
-	UCF 203	17	86	64	12	12
-	UCF 204	20	86	64	12	12
191897	UCF 205	25	95	70	14	12
191898	UCF 206	30	108	83	14	12
199655	UCF 207	35	117	92	16	14
199271	UCF 208	40	130	102	16	16
191901	UCF 209	45	137	105	18	16
191902	UCF 210	50	143	111	18	16
191903	UCF 211	55	162	130	20	19
191904	UCF 212	60	175	143	20	19
-	UCF 213	65	187	149	22	19
-	UCF 214	70	193	152	22	19
-	UCF 215	75	200	159	22	19
-	UCF 216	80	208	165	22	23

MODEL UCFL 200

ŠIFRA	OZNAKA	d (mm)	L (mm)	LA (mm)	B (mm)	H (mm)	d2 (mm)
-	UCFL202	15	113	90	60	11	12
-	UCFL203	17	113	90	60	11	12
-	UCFL204	20	113	90	60	11	12
191912	UCFL205	25	130	99	68	13	16
191913	UCFL206	30	148	117	80	13	16
191914	UCFL207	35	161	130	90	14	16
191915	UCFL208	40	175	144	100	14	16
191916	UCFL209	45	188	148	108	15	19
-	UCFL210	50	197	157	115	15	19
-	UCFL211	55	224	184	130	18	19
-	UCFL212	60	250	202	140	18	23
-	UCFL213	65	258	210	155	22	23
-	UCFL214	70	265	216	160	22	23
-	UCFL215	75	275	225	165	22	23
-	UCFL216	80	290	233	180	22	25

MODEL UCP 200

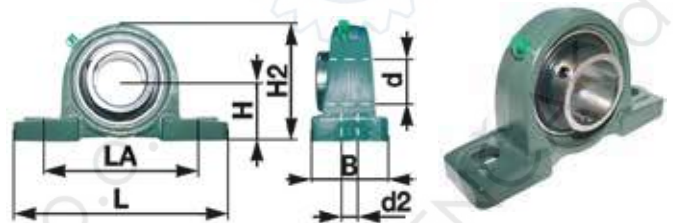

19

ŠIFRA	OZNAKA	d (mm)	L (mm)	LA (mm)	H (mm)	B (mm)	d2 (mm)	H2 (mm)
-	UCP 202	15	127	95	30,2	28	13	62
-	UCP 203	17	127	95	30,2	28	13	62
-	UCP 204	20	127	95	33,3	28	13	65
191905	UCP 205	25	140	105	36,5	38	13	71
191906	UCP 206	30	165	121	42,9	48	17	84
191907	UCP 207	35	167	127	47,6	48	17	93
191908	UCP 208	40	184	137	49,2	54	17	100
191909	UCP 209	45	190	146	54	54	17	106
191910	UCP 210	50	206	159	57,2	60	20	113
191911	UCP 211	55	219	171	63,5	60	20	125
-	UCP 212	60	241	184	69,8	70	20	138
-	UCP 213	65	265	203	76,2	70	25	150
-	UCP 214	70	266	210	79,4	72	25	156
-	UCP 215	75	275	217	82,6	74	25	162
-	UCP 216	80	292	232	88,9	78	25	171



KUGLIČNI LEŽAJEVI S KUĆIŠTEM

MODEL SBPFL 200

ŠIFRA	OZNAKA	d (mm)	L (mm)	LA (mm)	B (mm)	d2 (mm)
-	SBPFL 202	15	81	63	59	7,1
-	SBPFL 203	17	81	63	59	7,1
191893	SBPFL 204	20	90	71,5	67	9
191894	SBPFL 205	25	95	76	71	9
191895	SBPFL 206	30	113	90,5	84	11
191896	SBPFL 207	35	122	100	94	11
-	SBPFL 208	40	149	119	100	13,5

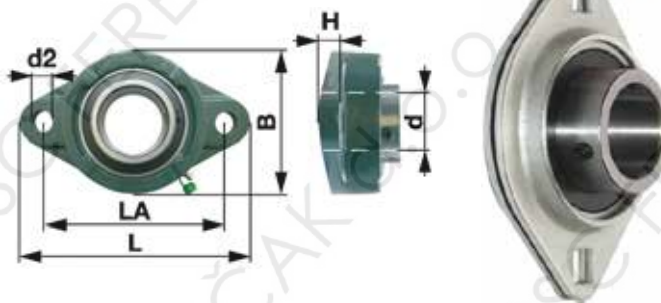

KUGLIČNI LEŽAJEVI ZA KUĆIŠTA

MODEL UC 200

ŠIFRA	OZNAKA	d (mm)	D (mm)	B (mm)	B2 (mm)
-	UC 202	15	47	17	31
-	UC 203	17	47	17	31
-	UC 204	20	47	17	31
-	UC 205	25	42	17	34,1
-	UC 206	30	62	19	38,1
199419	UC 207	35	72	20	42,9
-	UC 208	40	80	21	49,2
-	UC 209	45	85	22	49,2



MODEL UC 300

ŠIFRA	OZNAKA	d (mm)	D (mm)	B (mm)	B2 (mm)
-	UC 305	25	62	20	38
-	UC 306	30	72	23	43
-	UC 307	35	80	25	48
199268	UC 308	40	90	27	52
-	UC 309	45	100	30	57
-	UC 310	50	110	32	61
-	UC 311	55	120	34	66
-	UC 312	60	130	36	71



19

BAČVASTI LEŽAJEVI

MODEL SC

ŠIFRA	OZNAKA	d (mm)	D (mm)	B (mm)
190255	SC 204 2RS	20	47	14
191202	SC 205 2RS	25	52	14
191203	SC 206 2RS	30	62	16
190091	SC 207 2RS	35	72	17
191331	SC 208 2RS	40	80	18
198061	SC 209 2RS	45	85	19
197830	SC 210 2RS	50	90	20

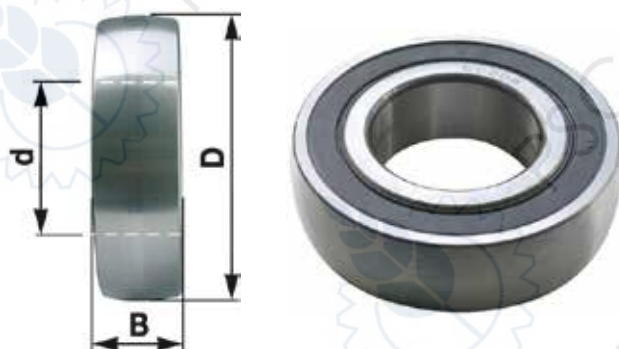



ULJNA BRTVILA (SEMERINZI)

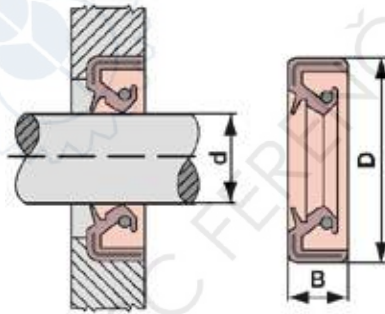

TC - dvorubna s dodatnim protuprašnim rubom

ŠIFRA	OZNAKA	d (mm)	D (mm)	B (mm)
199064	TC 20x42x10	20	42	10
199065	TC 20x47x10	20	47	10
199066	TC 20x52x7	20	52	7
199067	TC 25x47x10	25	47	10
199068	TC 25x50x10	25	50	10
199069	TC 25x62x10	25	62	10
199087	TC 30x50x10	30	50	10
199070	TC 30x55x10	30	55	10
199071	TC 30x62x10	30	62	10
199072	TC 30x72x10	30	72	10
199088	TC 35x52x10	35	52	10
199094	TC 35x52x8,8	35	52	8,8
199089	TC 35x55x10	35	55	10
199090	TC 35x55x10 sil.	35	55	10
199073	TC 35x62x10	35	62	10
199074	TC 35x72x10	35	72	10
199075	TC 35x80x10	35	80	10
199272	TC 38x62x7	38	62	7
199269	TC 40x52x7	40	52	7
199091	TC 40x55x7	40	55	7

ŠIFRA	OZNAKA	d (mm)	D (mm)	B (mm)
199414	TC 40x62x7	40	62	7
199076	TC 40x68x10	40	68	10
199077	TC 40x80x10	40	80	10
199078	TC 40x90x10	40	90	10
199093	TC 45x65x8	45	65	8
199079	TC 45x75x10	45	75	10
199080	TC 45x85x10	45	85	10
199081	TC 45x100x10	45	100	10
199092	TC 50x62x7	50	62	7
199413	TC 50x65x8	50	65	8
199082	TC 50x80x10	50	80	10
199083	TC 55x90x10	55	90	10
199084	TC 55x100x10	55	100	10
199085	TC 60x95x10	60	95	10
199086	TC 60x110x12	60	110	12
199047	TC 64x80x8	64	80	8
199270	TC 78x95,5x12,7	78	95,5	12,7
199279	TC 85x102x13	85	102	13
199420	TC 110x150x13	110	150	13

19 SPREJEVI

ŠIFRA	Naziv	Opis
199233	Sprej CD 40	Višenamjenski sprej
199234	Sprej CDKS	Sprej za podmazivanje lanaca
199235	Sprej CDZH	Cinkov sprej za maje popravke
199236	Sprej CDMO	Sprej za uklanjanje nečistoća pri montaži
204009	Mast adhezijska	Adhezijska mast u spreju 400 mL
194840	Start sprej STR 400	Sprej za lakše paljenje motora
204986	Sprej za čišćenje kočnica	400 mL Forch
203497	Sprej univerzalni S6 PLUS	Univerzalni sprej 400 mL
202291	Antikoroziv	Sprej za odstranjivanje rđe
202289	GP 400 univerzalni sprej	Univerzalni sprej
203174	Aprej A 100	Aluminijski sprej
204271	GP silikon 400 mL	Silikonski sprej
205094	Sprej za čišćenje kočnica	CARAMBA 400 mL za čišćenje kočnica
202290	Sprej za čišćenje kočnica	GRANIT sprej za čišćenje kočnica
202293	Cinkov sprej	Granit cink sprej





Prostor za bilješke

A large grid area for taking notes, overlaid with a large, faint watermark of the PSC FERENČAK logo and the company name.

PSC ferencak





TRAKTORSKI DIJELOVI



KABINA I UPRAVLJANJE (STAKLA, AMORTIZEI, RETROVIZORI, MOTORI BRISAČA I MOTORI VENTILACIJE, SPONE, KRAJNICI I DIJELOVI UPRAVLJAČA)	260-268
FILTRI (FILTRI GORIVA, ULJA I ZRAKA)	269-272
SUSTAV ZA GORIVO (AC PUMPE, ČEPOVI REZERVOARA, CRIJEVA ZA GORIVO, DIZE, GRIJAČI)	273-274
SUSTAV HLAĐENJA MOTORA	275
DIJELOVI I SKLOPOVI MOTORA TRAKTORA	276-277
HIDRAULIČNE PUMPE, LAMELE I KVAČILA	278
KOČNICE I ISPUŠNI SUSTAV	279
ELEKTRIKA (ANLASERI, ALTERNATORI, ELEKTRIČNA INSTALACIJA, SVJETLA I SIGNALIZACIJA, STOPICE I ALAT ZA APAJANJE, ŽARULJE, UTIČNICE I UTIKAČI, OSIGURAČI, TROKUTI ZA SIGNALIZACIJU, KATADIOPTERI I NALJEPNICE PRIKLJUČNIH VOZILA, UPUTE ZA SPAJANJE INSTALACIJE PRIKLJUČNIH VOZILA)	280-291
SUSTAV KOPČANJA I VUČE (HIDRAULIČKE TOPLING POLUGE, MEHANIČKE TOPLING POLUGE, DIJELOVI I PRIBOR ZA TOPLING POLUGE, KUKE S AUTOMATSKIM KOPČANJEM I KUKE BRZOG KOPČANJA)	292-298
ZATVARAČI STRANICA PRIKOLICE, VIJCI KOTAČA, BLATOBRA NI I OSOVINE	299-300
TRANSMISIJA I ODRŽAVANJE	301-303
IZRADA HIDRAULIČKIH CRIJEVA	304



STAKLA KABINE

Case IH

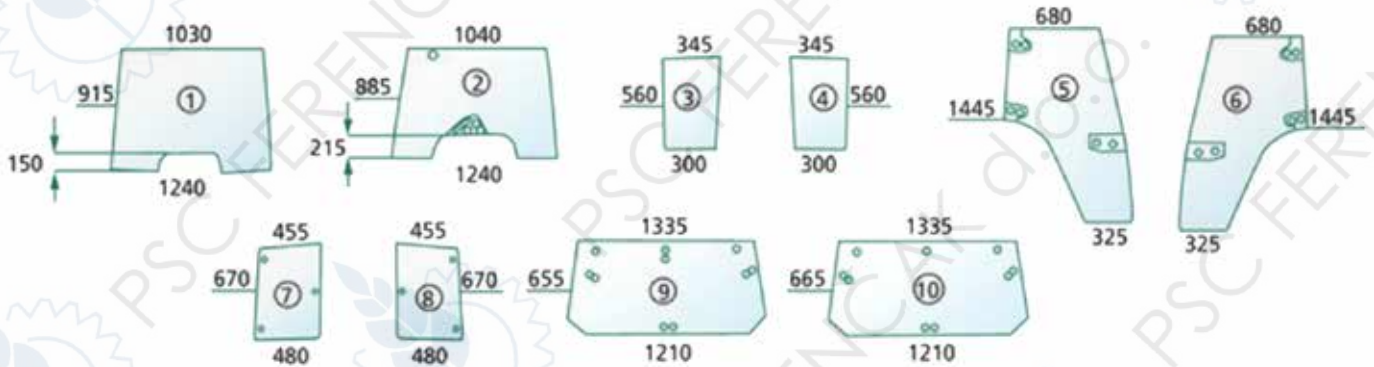

NAZIV	KAT. BR.	SLIKA BR:
Prednje vjetrobransko staklo	048650S34671067	1
Prednje vjetrobransko staklo zarezano	048650S34671060	2
Prednje donje vjetrobransko staklo D	048650S34671069	3
Prednje donje vjetrobransko staklo L	048650S34671070	4
Staklo vrata D	048650S34621081	5
Staklo vrata L	048650S34621080	6
Bočno staklo D	048650S34671065	7
Bočno staklo L	048650S34671064	8
Stražnje staklo sa brisačem	048650S34671072	9
Stražnje staklo	048650S34671071	10

Odgovara za modele: CS78, 80, 85, 86, 90, 94, 100, 105, 110, 120, 130, 150, CVX 120, 130, 140, 150, 160, 170, 195, 1135, 1145, 1155, 1170, 1190

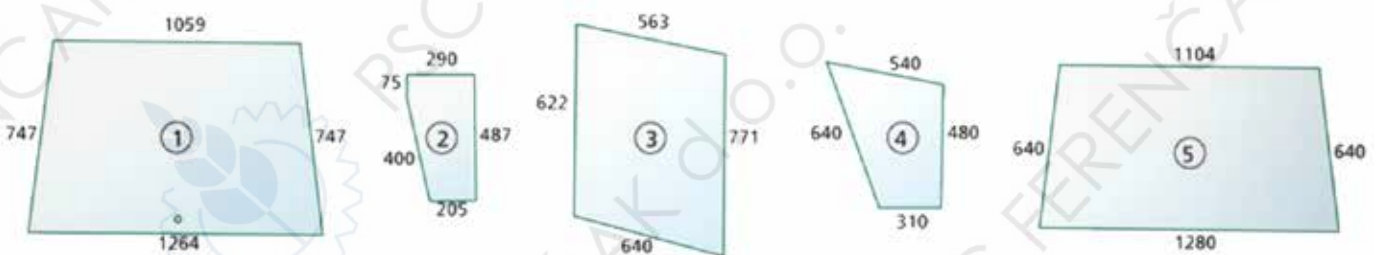

NAZIV	KAT. BR.	SLIKA BR:
Prednje vjetrobransko staklo	048650880604	1
Prednje vjetrobransko staklo donje D, L	048650881104	2
Staklo vrata gornje D, L	048650880809	3
Staklo vrata donje D, L	048650880957	4
Stražnje staklo	048650880906	5
Gumene brtve	650921450/5	

Odgovara za modele: 433, 533, 633, 733, 833, 554, 644, 744, 844
Kabina Fritzmeier Euro II FK 9115, Perfekt 33-44 i 46



STAKLA KABINE

Deutz

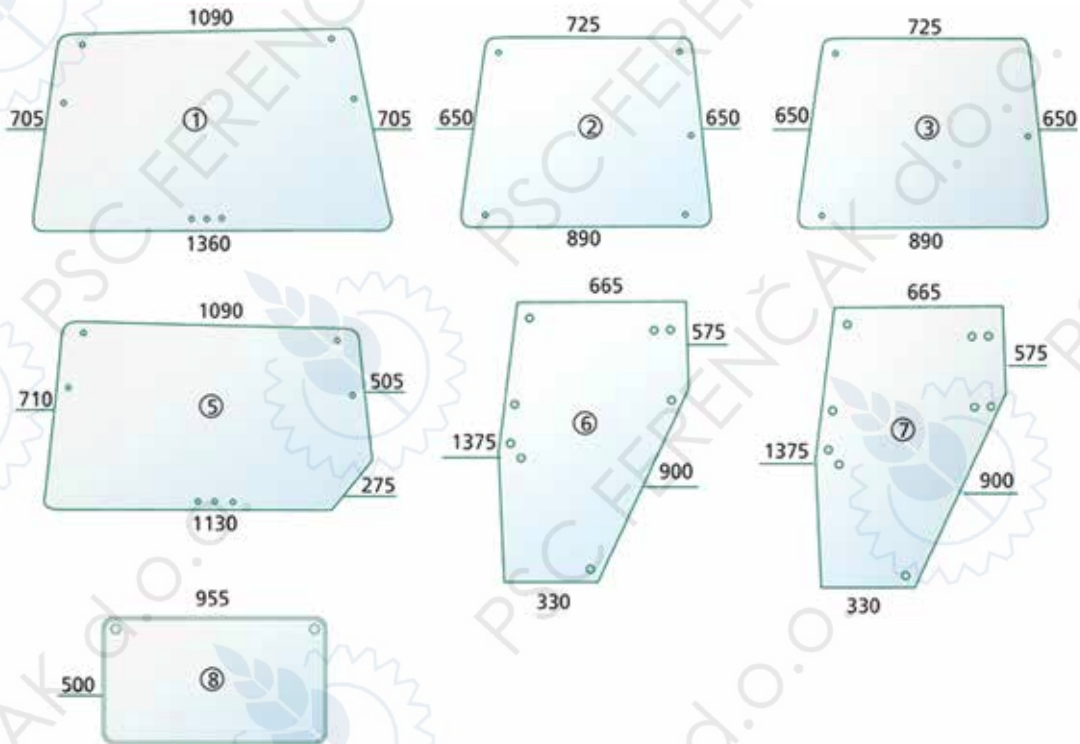

NAZIV	KAT. BR.	SLIKA BR:
Prednje/stražnje vjetrobransko staklo gornje prozirno	048650886100	1
Prednje/stražnje vjetrobransko staklo gornje tonirano	048650886105	1
Bočno staklo D, L prozirno	048650885535	2
Bočno staklo D, L tonirano	048650883441	2
Bočno staklo prozirno	048650886026	3
Bočno staklo tonirano	048650886027	3
Stražnje staklo s utorom prozirno	048650886102	5
Stražnje staklo s utorom tonirano	048650886107	5
Staklo vrata L prozirno	048650S347340	6
Staklo vrata D prozirno	048650S347341	6
Staklo vrata L tonirano	048650S347342	6
Staklo vrata D tonirano	048650S347343	6
Staklo vrata L prozirno	048650S358527	7
Staklo vrata D prozirno	048650S358528	7
Staklo vrata L tonirano	048650S358529	7
Staklo vrata D tonirano	048650S358530	7
Stražnje staklo donje prozirno	048650883468	8
Gumene brtve za staklo	048650921394/5	1, 2, 3, 5

Odgovara za modele: DX 4.10, 4.30, 4.50, 4.70, 6.05, 6.10, 6.30, 6.50, 7.10
 Kabina: DX-SC (Starcab)

Napomena: Sve dimenzije stakala na crtežima iskazane su u milimetrima!



STAKLA KABINE

Fendt

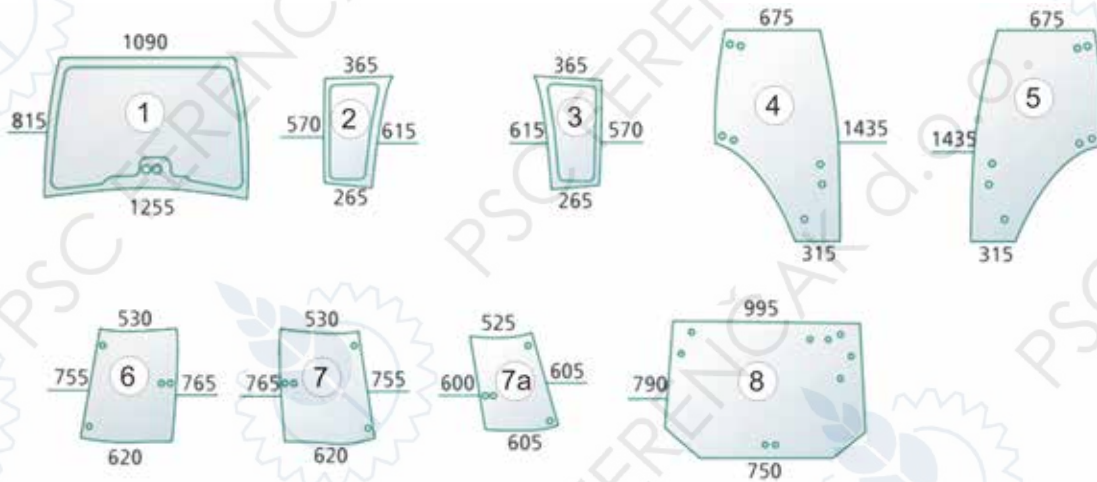

NAZIV	KAT. BR.	SLIKA BR:
Prednje vjetrobransko staklo	048650806031	1
Prednje donje vjetrobransko staklo D	048650806033	2
Prednje donje vjetrobransko staklo L	048650806032	3
Staklo vrata D	048650806036	4
Staklo vrata L	048650806035	5
Bočno staklo D	048650806030	6
Bočno staklo L	048650806034	7
Bočno staklo L (donje)	04865006036	7a
Stražnje staklo	048650886506	8

Odgovara za modele: Farmer 409, 410, 411, 412, Favorit 711, 712, 714, 716, Fendt 411, 412, 413, 414, 415, 711, 712, 714, 716, 718, 815, 817, 818, 820

Nova kabina sa staklenim vratima bez okvira i filterom kabine ispod bočnog stakla.

NAZIV	KAT. BR.	SLIKA BR:
Prednje vjetrobransko staklo	048650806031	1
Prednje donje vjetrobransko staklo D	048650806038	2
Prednje donje vjetrobransko staklo L	048650806037	3
Staklo vrata D	048650806036	4
Staklo vrata L	048650806035	5
Bočno staklo D	048650806030	6
Bočno staklo L	048650806034	7
Stražnje staklo	048650886506	8

Odgovara za modele: Farmer 307, 308, 309, Favorit 916, 920, 924, 926, Fendt 309, 310, 311, 312, 916, 924, 926, 930

Nova kabina sa staklenim vratima bez okvira.

20



STAKLA KABINE

John Deere

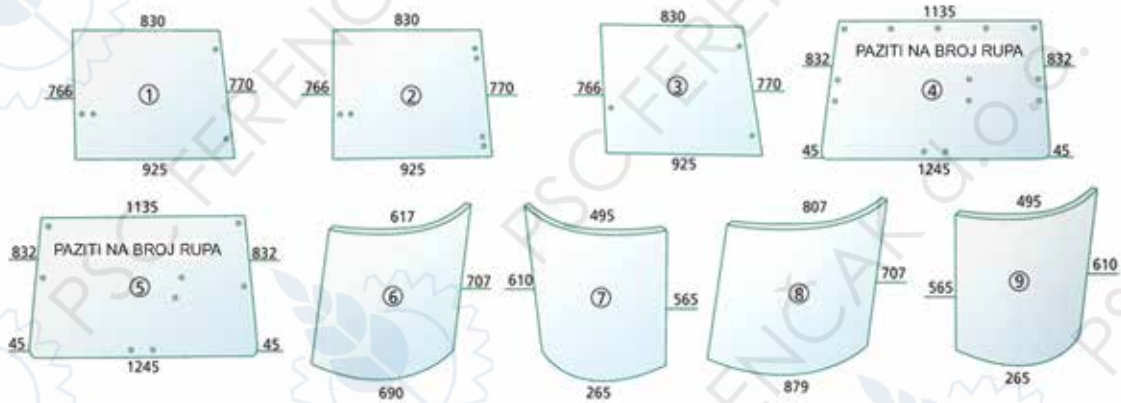

NAZIV	KAT. BR.	SLIKA BR:
Bočno staklo zeleno	048650885639	1
Bočno staklo (2 otvora - šarke) zeleno	048650885548	2
Bočno staklo zeleno	048650886020	3
Stražnje staklo stari model (5 otvora - šarke) zeleno	048650813840	4
Stražnje staklo novi model (2 otvora - šarke) zeleno	048650815900	5
Staklo vrata gornje (lijevo ne odgovara za seriju 50) zeleno	04865050755	6
Staklo vrata donje (lijevo ne odgovara za seriju 50) zeleno	04865052577	7
Prednje staklo gornje, D	04865050753	8
Prednje staklo donje, D	04865052576	9
Gumene brtve za stakla	048650921394/5	1, 2, 3, 4, 5

Odgovara za modele: 1640, 2040, 2040S, 2140, 2250, 2450, 2650, 2650N, 2850, 3040, 3050, 3140, 3150, 3350, 3640, 3640S, 4040S, 4050, 4055, 4240S, 4250, 4255, 4450, 4455, 4650, 4850
Kabina SG 2 od serije 071269

New Holland



20

NAZIV	KAT. BR.	SLIKA BR:
Prednje vjetrobransko staklo tonirano	04865017073	1
Staklo vrata D tonirano	04865017072	4
Staklo vrata L tonirano	04865017071	5
Bočno staklo tonirano	04865017075	6
Stražnje staklo tonirano	04865017074	7

Odgovara za modele: T 3010, 3020, 3030, 3040, TCE 40, 45, 50, 55



STAKLA KABINE

SJEDALA KABINE

ŠIFRA NAZIV

204063 Staklo kabine stražnje Case



204143 Staklo kabine stražnje donje Deutz-Fahr



204179 Staklo kabine stražnje SG2 John Deere



205006 Staklo kabine stražnje John Deere



204787 Staklo kabine stražnje gornje Renault



204521 Staklo kabine stražnje Valtra



ŠIFRA NAZIV

198501 Sjedalo univerzalno
 - nosivost 50-120 kg
 - podesiva udaljenost 220 mm
 - podesiv nagib sjedeće konzole u pet koraka 12°, 16°, 20°, 25° i 42°



201081 Sjedalo veliko zračno
 - podesiva udaljenost 150 mm po 10 mm
 - podesiva visina 60 mm
 - podesiv nagib 0-15°
 - presvlaka tkanina



201080 Sjedalo univerzalno malo
 - nosivost 50-110 kg
 - podesiva udaljenost 150 mm
 - progib opruge 80 mm

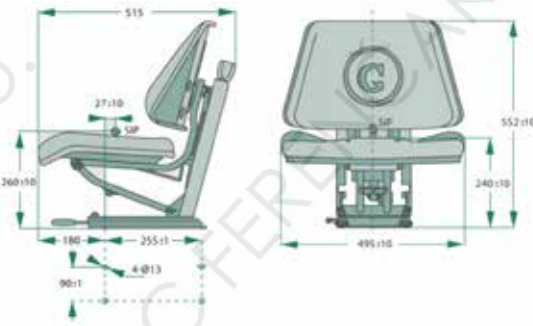

205671 Sjedalo zračno GRAMMER MSG 95G/721 tkanina

205535 Sjedalo GRAMER Maximo M sa okretištem 360° kpl.

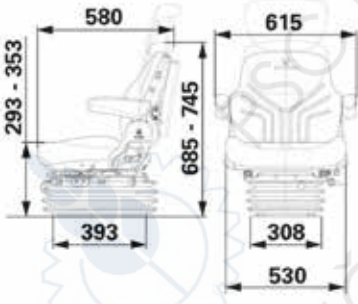

20

Traktorske kabine i ostale dijelove naručujemo prema željama kupaca. Nudimo asortiman poznatih proizvođača: Case, Deutz-Fahr, John Deere, Renault i mnogih drugih. Za sve pitanja se obratite u naše trgovine putem telefona ili e-maila: info@psc-ferencak.hr



SJEDALA I AMORTIZERI ZA SJEDALA

ŠIFRA	NAZIV	ŠIFRA	NAZIV
202163	Pomoćno sjedalo John Deere 	204987	Sjedalo mehaničko - tkanina crna - 430x750 mm - progib opruge 90 mm 
202631	Amortizer sjedala Grammer - prihvat Ø 6/21 mm - hod min/max 125-194 mm Za modele: MSG95, LS95H1 121390 	200477	Amortizer sjedala Grammer Za modele: MSG83, 93 122885 
205016	Amortizer sjedala Grammer ACC252SA 		

AMORTIZERI ZA STAKLA I VRATA

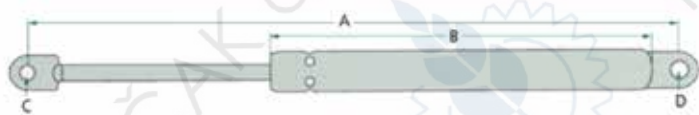

TIP 1

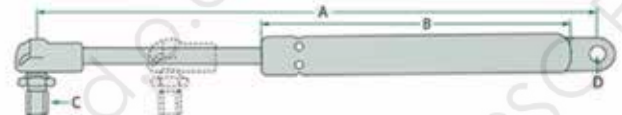

TIP 3



TIP 6



ŠIFRA	NAMJENA	Za modele	KAT.BR.	TIP	A(mm)	B(mm)	C(mm)	D(mm)	Sila(N)
204605	podizanje stakla	MF	3902140M1	6	585	290	10	10	150
202328	podizanje stakla	Case	3234163R1	6	550	278	10	10	200
202958	prednje staklo	Fendt	X800420490000	6	605	305	10	10	210
203387	krovno staklo	Fendt	X800420446000	1	225	130	6	6	120
205037	prednje staklo	Fendt	X800420490000	6	605	305	10	10	210
205566	vrata /str. staklo	Fendt	H205810040030	6	505	255	10	10	150
205567	prednje staklo	Fendt	X800420489000	6	600	310	10	10	250
205563	zadnje staklo	Fendt	7700044591	6	565	280	10	10	175
205582	staklo vrata	Case	3232937R1	6	280	130	13	13	350
204676	staklo vrata	Deutz	04429617	6	250	125	10	10	750
204448	staklo vrata	John Deere	AL60324	3	500	245	8	8	165
204077	zadnje staklo	Steyer	199976047	3	585	295	8	8	100
203717	vrata	Fendt	H816810030500	6	325	160	10	10	250
205637	vrata	Fendt	610028500	1	500	300	8	8	280
204733	vrata	Fendt	F258514210020	6	275	135	10	10	200
205651	prednje staklo	New Holland	47108190	6	585	290	10	10	150
205601	vrata	Case	134621099	6	205	105	8	8	500



RETROVIZORI, DRŽAČI RETROVIZORA I GUMENE KOPČE

ŠIFRA	NAZIV	ŠIFRA	NAZIV
205647	Retrovizor Deutz-Fahr, Fendt, Same Ø18 314x228 mm	205645	Nosač retrovizora Fendt
205540	Retrovizor Ø 20 mm 236x180 mm 5126233	204766	Klema retrovizora
204765	Retrovizor Ø18 225x312 001035640	205258	Nosač retrovizora - duljina 275 mm - širina 375 mm - prihvat Ø16, vijak M6
204134	Retrovizor Ø 16/ Ø 22 Case IH Za modele: Maxum 100, 110, 115, 120, 125, 130, 140 MXU 100, 110, 115, 125, 130, 135 Puma 115, 125, 140, 155, 165, 165CVX, 180, 180CVX, 195, 195CVX, 210, 210CVX, 225, CVX	04865415231	Retrovizor sa teleskopskim nosačem D/L 4285291M91 Za modele: MF8450, 8470, 8480, 8670
194887	Gumena zakačka	194696 194697 194892	Gumena zakačka L=65 mm L=120 mm L= 160 mm

BRISAČI, MOTORI BRISAČA I MOTORI VENTILACIJE

NAZIV	NAZIV
04865402030 Motor brisača 12V, 135° - hod 55 mm Za modele: Case IH, Deutz, John Deere, New Holland	04865406087 Motor brisača Fendt 12V 104° Za modele: Farmer
04820099018 04820099015 04820044636 04865499009 04865499010 04820099016 04865499011 04820099017 Brisač vjetrobranskog stakla Duljina: 305 mm 12" 355 mm 14" 406 mm 16" 457 mm 18" 508 mm 20" 559 mm 22" 610 mm 24" 711 mm 28"	205586 205587 Motor ventilacije grijanja AL58527 Desni Ø 160 mm AL58526 Lijevi Ø 160 mm Za modele: John Deere i Fendt
04865491114 Posudica za vodu s pum- pom 12V; 1,5L	04865404024 Motor ventilacije 12V Za modele: DX, AgroPrima, AgroXtra, AgroStar



SPONE, KRAJNICI, UPRAVLJAČI I RUČICE UPRAVLJAČA

ŠIFRA	NAZIV	ŠIFRA	NAZIV
04838702113	Krajnik spone - konus 14/16 - duljina 350 mm	203980	Krajnik spone aksijalni zglob M18x1,5 M20x1,5 navoj 57 mm
048702119	Krajnik spone M24x1,5 konus 18/20 duljina=105 mm za model Landini	204129	Krajnik spone - konus 23,5/26,4 - duljina 290 mm - unutarnji navoj M20x1,5
04838715011	Spona duga L= 1180 mm Konus 17/19 mm 885549M91 Za modele: MF 165, 175, 178, 188, 265, 275, 285, 290	204898	Krajnik IMT kosi (modeli 533-549)
0483874442	Upravljač - konus 20/21,5 mm - dubina 77 mm	204899	Krajnik IMT ravni (modeli 533-549)
0483874443	Zaštitni poklopac Ø 50 mm	204980	Krajnik IMT M20 (za modele 560)
205145	Ručica upravljača univerzalna	203875	Ručica upravljača univerzalna PVC
203876	Ručica upravljača univerzalna Lenkrad	201345	Ručica upravljača univerzalna

20

Za sve potrebne dijelove poljoprivrednih strojeva informirajte se u našim poljoprivredno-servisnim centrima u Križevcima, Koprivnici, Virovitici, Bjelovaru i Osijeku ili putem e-maila

info@psc-ferencak.hr



KRIŽEVI KARDANA

Kardanski prijenos za prednji traktorski pogon

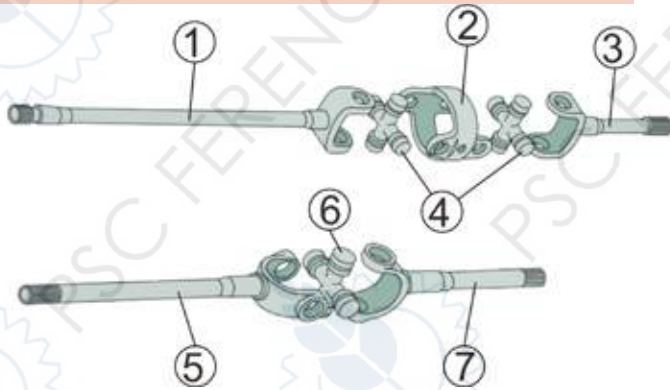

- ① Vilica D za dvostruki zglob
- ② Srednji dio zgloba
- ③ Vilica L za dvostruki zglob
- ④ Križ za dvostruki zglob
- ⑤ Vilica L kardanskog vratila
- ⑥ Križ
- ⑦ Vilica D kardanskog vratila

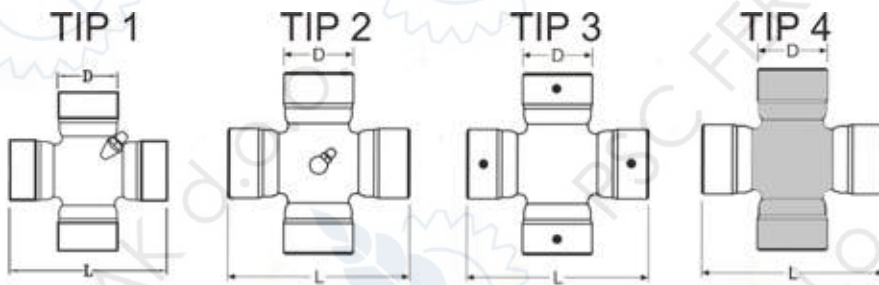

Prilikom odabira obratite pažnju na odgovarajući tip križa (vidi sliku).

ŠIFRA	NAZIV	KAT.BR.	TIP	D(mm)	L(mm)
205248	Križ traktorski	CR120	3	27	70,6
205251	Križ traktorski	CR351	4	27	81,7
205253	Križ traktorski	CR391	1	27	81,7
205250	Križ traktorski	CR375	3	28,5	70,6
205254	Križ traktorski	CR98	1	30,17	92
205249	Križ traktorski	CR360	3	30	83
205247	Križ traktorski	C371	2	34	97
205252	Križ traktorski	CR22	2	35	96,8
205255	Križ traktorski	CR373	1	38	106

20

NAZIV

04872702101 Vilica kardanskog sklopa za prednji pogon kratka za CaseIH 3216600R91



04872702102 Vilica kardanskog sklopa za prednji pogon duga za CaseIH 3216602R91



NAZIV

04872702108 Srednji dio dvostrukog kardanskog zgloba za prednji pogon za Case IH 89523C1



Vršimo ugradnju svih vrsta traktorskih križeva u poljoprivredno-servisnim centrima u Križevcima i Osijeku.

Za sve informacije se obratite na telefone:

Križevci
Osijek

tel.: 048 681 902

tel.: 031 211 902

ili e-mailom

info@psc-ferencak.hr



FILTERI GORIVA, ULJA I ZRAKA



FILTER GORIVA

ŠIFRA PSC	MAN	DONALDSON	GRANIT	VODENI SEPARATOR	ODGOVARA ZA MODELE
195207					URSUS
190346					URSUS
190347					URSUS
203935			A650110010		BELARUS
201584	P917X	P502420 P556245	8001015		CASE, FIAT, FORD, JD
203463			8001004		CLAAS, KRONE, NH
204559	BFU90X		BFU900X		DEUTZ FAHR
203930	WK9405	P554620	8001010		CLAAS, FENDT, DF
201582	WK731	P553004	8001007		DF, FENDT
201580	WDK725	P550498	8001063	DA	DF, FENDT
204016	PU815X	P550837	8001075		DF, FENDT, VOLVO
201573	WK712.2	P550345	8001006	DA	DF, FENDT, LAMBORGHINI
201583	WK723	P553004	8001011		DF, FENDT, RENAULT, MF
204398	P811	P550861	8001023		DF, FENDT, RENAULT
202112			8002053		DF, MERCEDES
201575	WK842	P550588 P550587	8001013	DA	DF, MF, CASE, FENDT, FIAT
202283	PU815X	P550837	8001075		DF, SAME
201574	WK842.2	P550588	8001012	DA	FENDT
201576	P707	P550060	8001024		CASE, FENDT, SAME, STEYR
201379					IMT
201378					IMT
201578	WK13001	P551130	8001033		JD
204110	WK8161	P551435	8001060	DA	JD, CLAAS, McCORMIK
204406	WK8162	P551422	8004040	DA	JD, CLAAS, RENAULT
202715	WK8153	P551434	8001054	DA	JD, NH, STEYR
201579	WK8102	P551424	8001035		JD, RENAULT, CLAAS
201585	P945X	P556287	8001017		MF, LAMBORGHINI, RENAULT
203748	WK8140	P551430	87840591	DA	NH
201581	BFU700X	P550120	8001003		NH, CLAAS
203518	WK8114	P551425	8001036		NH, STEYR, FIAT, FORD
202268			SN70274		SAME, DF, HURLIMAN
201572	BFU707	P550860	8001001		SAME, STEYR, CASE
190844					IMT
193437					URSUS
040514					ZETOR
190020			8001076		ZETOR

**FILTERI GORIVA, ULJA I ZRAKA****FILTER ULJA HIDRAULIKE**

ŠIFRA PSC	MAN	DONALDSON	GRANIT	ODGOVARA ZA MODELE
204183	H1059.2		8002182	DF, CASE, FENDT
202111			HF6710	BURGOIN
201595	HD612.2X		8002086	CASE, IH
201596			8002088	CASE, IH
201606	W1374.6		8002184	DF
204669	WD962	P556230	8004030	DF, MF, HAKO
201987	W962.15	P552410	8002174	DF, CASE
201594	WD950.5		8002076	DF, FENDT
201607	WD950.4		8002185	DF, FENDT
203695	H10592		8002182	DF, FENDT, STEYR
204443	WD950.2	P763956	8002176	DF, SAME, HURLIMANN
202344	H617N		8002054	DF, TORPEDO
201604	H618		8002172	FENDT
201597			8002126	FENDT
201602			8002149	FIAT
201603	H1263.1	P555603	8002165	JD
202625	WD950.3	P555060	8002192	JD
203987			8002074	JD
201605	WH980	P164384	8002181	JD, CASE
201650	WH945	P764668 P164381	8002180	JD, FORD
204450			9209240	KRONE
204668	WD920		WD920	MANN MAMUT
202333	H729		8002187	MB
201648			8002142	MF
201601			8002143	MF
201598	W1387		8002134	MF
201600			8002140	MF
201640			8002075	MF
201599	HD513.11	P762860	8002135	MF, RENAULT
202420			8002212	RENAULT, CLAAS
202421			HF28808	RENAULT, CLAAS
204015	W951.5		8002175	STEYR
204172	SPH9542		8002091	STEYR

20



FILTERI GORIVA, ULJA I ZRAKA



FILTER ULJA MOTORA

ŠIFRA PSC	MAN	DONALDSON	GRANIT	ODGOVARA ZA MODELE
201590	W930	P550942	8002029	CASE, FENDT, RENAULT
201637	W920.23	P550939	8002016	CASE, IH
201639	W930.7	P550942	8002028	CASE, IH
201633	W950.1	P558250	8002005	CASE, IH
201588	W920	P550942	8002015	CASE, RENAULT
201632	W940.24	P554403	8002003	CLAAS, JD, MF, CASSE
203464	H12110.2X	P550041	8002042	CLAAS, KRONE, MENGELE
202978	W11102.36		8002021	CLAAS, LAVERDA, MENGELE
203106	HU932.4X	P550766	8002055	CLAAS, MERCEDES
201647	PF815	P556915	8002043	DF
201986	W11102	P551102	8002173	DF
201634	W962	P553771	8002006	DF, JD, CASE, FENDT, STEYR
201635	W940.5	P559418	8002009	DF, JD, FENDT, KUBOTA
202282	HU947.2X	P550451	8002067	DF, SAME
201591	W940	P550006	8002030	FENDT, STEYR
204394	H121103	P550041	H12110/3	FENDT, MF, VALTRA
201587	W1140	P553411	8002008	FIAT, FORD, SAME
201738	W8005	P551603	8002007	FIAT, FORD, SAME
203931			320/04133	JCB
201636	W936.4	P550020	8002010	JD
201592	W67.1	P502067	8002032	JD, KUBOTA
201593	W820.3X		8002037	MF, FORD, IMT
201589	W732.3		8002020	MF, LANDINI, RENUAT
201631	W940.1	P550008	8002002	MF, LANDINI, RENAULT
201638	W950.7	P554407	8002022	MF, LANDINI, SAME, CASE
201649	W1140.11	P502433	8002164	MF, NH, CASE, STEYR
201742	H827.1N	P550183	8002038	MF, SAME, VALMET
202348			8002117	NH
202221	HU931X		8002186	SAME, DF, HURLIMAN



FILTERI GORIVA, ULJA I ZRAKA

FILTER ZRAKA MOTORA I KABINE

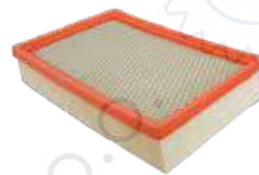

ŠIFRA PSC	MAN	DONALDSON	GRANIT	V - VANJSKI U - UNUTARNJI K - KABINA	MARKA
202218	C24719	P181034	AF418	V	BOURGOIN
201651	CF1000	P776695	8003001	U	CASE, DF, JD, FENDT, STEYR
201739	CF700	P777524	8003007	U	CASE, FENDT, STEYR
202346			8003064		CASE, STEYR
201610	CF711	P777759	8003003	U	DF
201741	C17250	P771557	8003031	V	DF
203467	CF830	P781352	8003120	U	DF
201922	CF1200	P776696 P776694	8003014	U	DF
201643	CF600	P777523	8003021	U	DF, CASE, JD, STEYR
201613	CF1000	P776695	8003012	U	DF, CASE, FENDT, JD, MB
201623	CF820	P775704	8003125	U	DF, FENDT
201621	CF400	P780012	8003121	U	DF, FENDT, JCB, MF
201642	C17134	P771594	8003017	V	DF, JD
201609	CF800	P776694	8003002	U	DF, JD
201611	CF1200	P776696, P776694	8003004	U	DF, JD, MB, FENDT
204392	C20500	P778994	8003128	V	DF, LAMBORGHINI, MF
201654	C16400	P778972	8003119	V	DF, MF, FENDT, JCB
203407			8003175		DF, MF, LANDINI
201644	CF840	P130776	8003025	U	DF, MF, SAME, LANDINI
202284	C21560.1	P777588	8003063	V	DF, SAME, CASE, STEYR
201641	C15165.3	P181089	8003016	V	FENDT, CASE, JD, STEYR
201645	C17201	P771593	8003034	V	FENDT, DF
201619			8003060		FENDT, FIAT, FORD, JD, MF
201614	C14179	P181052	8003023	V	FIAT, CASE, JD, MF, KUBOTA
201618	C17337.2	P828889	8003051	V	FIAT, KUBOTA, FORD
201850			8003052		FIAT, KUBOTA, FORD
201612	CF930	P770960	8003006	U	JD
201616	CF840	P130776	8003032	U	JD, SAME, LAMBORGHINI
201617	C18267		8003043		MF
201652			8003010		MF, FORD
202286	C14210.2	P772579	8003050	V	MF, NH, FIAT, FORD
201653	C17225.3	P500929 P181088	8003013	V	RENAULT
201615	CF922	P119410	8003029	U	FENDT, DF, JD, CASE
204393	CF500	P780036	8003132	U	DF, MF, LAMBORGHINI
201620			8003069	K	CASE
201622	C48140		8003122	K	DF
201767	C55102		8003123	K	DF
201624	CUK6046		8004023	K	FENDT
201630	C4694			K	FENDT
201740	C30154		8004002	K	FENDT
204518			L57264	K	JOHN DEERE
202799			AF26231	K	STEYER

20



PUMPE ZA GORIVO (AC PUMPE)

ŠIFRA	NAZIV	ŠIFRA	NAZIV
204022	Pumpa goriva odgovara za Deutz-Fahr 3 rupe	205032	Pumpa goriva odgovara za MF 575 2 rupe
204131	tip motora F3L912, F6L912, F5L912, F3L812D, F4L812D, F4L912, F4L913, F6L913, FBF4L913 2000087, 04231021		tip motora Perkins
205516	Pumpa goriva za model Fendt Favorit 2 rupe	205010	Pumpa za gorivo za model John Deere 1169 2 rupe
204133	Pumpa za gorivo za modele CaselH, Eicher, Landini, Lindner, Steyr 4 rupe razmak 25x45 mm duljina flanče 27 mm	205571	Pumpa za gorivo za model MF 4 rupe 4224706M91
204132	Pumpa za gorivo za modele CaselH, MF, Steyr, Valtra-Valmet 5 rupa okomiti razmak 25/37 mm horizontalni razmak 45 mm duljina flanče 52 mm	205031	Pumpa za gorivo za modele Eicher, Landini, Lindner, MF 2 rupe razmak 45 mm duljina flanče 33 mm

POKLOPAC REZERVOARA ZA GORIVO



20

ŠIFRA	NAZIV	KAT.BR.	Za modele	Ø (mm)
202392	Čep rezervoara za gorivo	3221253R1	Case IH	67
202548	Čep rezervoara za gorivo	AL34678	Case IH	80
202796	Čep rezervoara za gorivo PVC	3307650M91	MF, Landini	58/62
-	Čep rezervoara za gorivo	38060007	Fendt	80



IZRADA CRIJEVA ZA GORIVO PO MJERI



IZRAĐUJEMO SVE VRSTE CRIJEVA ZA GORIVO PO MJERI I S ODGOVARAJUĆIM PRIKLJUČCIMA.

DIZE ZA GORIVO I GRIJAČI

ŠIFRA	NAZIV		ŠIFRA	NAZIV	
	Diza goriva CaselH Za modele: 353, 383, 423, 433, 453, 533, 633, 523, 553, 624, 644, 654, 724, 824 048380002122			Diza goriva Deutz Za modele: Motori: F6L413, F8L413F, F8L413V, F10L413F, F10L413V, F12L413F, F12L413V 04838099249	
04838099259	Diza goriva Fendt Za modele: Favorit 816, 818, 822, 824, 916, 920, 924, 926, XYLON, 520, 522, 524 EF824200710030		04838015348	Diza goriva MF Za modele: 5245, 4255, 4265, 6130 3640923M1	
04838099294	Grijač za Deutz 11V; 20A, M20x1,5 001507704		04838060070	Grijač Fendt 9,5V; 20A, M20x1,5 X830030126000	
04838099170	Griječ John Deere 12V; 18A, M7/8"-14UNF AT26190		04838099174	Grijač Fiat 12V; 1/2" 5161845	

20



SUSTAV HLAĐENJA MOTORA

ŠIFRA	NAZIV	ŠIFRA	NAZIV
202423	Vodena pumpa traktora John Deere Za modele: 239, 3029, 3179, 4039, 4239, 840, 940, 1040, 1140, 1350, 1550, 1640, 1750, 1840, 1850, 2040, 2140, 2250, 2450, 2650, 2850, 5200, 5300, 5400, 5500	203932	Vodena pumpa traktora John Deere - odgovara za Renault Za modele: D 310, D 239, D 358, DT 402, DT 310
204136	Vodena pumpa za traktor MF		Vodena pumpa za traktor MF s remenicom 3641823M91
04874702072	Gumeno crijevo koljenasto 90°, promjer 38 mm Za modele: Case IH 353, 383, 423, 453, 433, 533, 440, 540, 740, 523, 624, 644, 654, 946, 1046, 955+1055 sa D310	04874718009	Gumeno crijevo "S" promjer 23 mm iznad termostata Za modele: Renault

Kod nas možete naručiti vodene pumpe i gumena crijeva za sve ostale modele.

ŠIFRA	NAZIV	ŠIFRA	NAZIV
205573	Hladnjak traktora (DXŠXV) 480x110x635 - gornji otvor Ø 45 mm - donji otvor Ø 38 mm	204895 204896 204894 100434	Hladnjak traktora IMT 533 IMT 539 IMT 560 IMT 577
04874723005	Hladnjak traktora Zetor Za modele: 3320, 3340, 4320, 4340, 4911, 5011, 5211, 5245, 5320, 5340, 5545, 5645, 5647, 5711, 5718, 5745, 5748, 5911, 5945, 6011, 6045, 6211, 6245, 6320, 6340, 6711, 6718, 6745, 6748, 6911, 6945, 7011, 7045, 7211, 7245, 7711, 7745	204137	Čep hladnjaka Ø 57 mm, visina 25 mm Za modele: CaselH, Claas, Fiat, Ford, John Deere, New Holland, Steyr
204138	Čep hladnjaka Ø 57 mm, visina 31 mm Za modele: John Deere 1001, 1201, 6201, 7701, 2000, 2100, 2200, 2300, 2400, 2700, 2800	204140	Čep hladnjaka Ø 58 mm, visina 26 mm, otvaranje na 0,5 bar Za modele: CaselH, David Brown, MF
205539	Termostat Ø 54, 83°C Za modele: Case IH Maxum 5120, 5130, 5140, 5150, 5120 Pro, 5130, Pro, 5140 Pro, 5150 Pro, MX 110, 120, 135, 150, 170	204135	Termostat Ø 54; 82°C Za modele: Case IH, David Brown, JCB, John Deere, Landini, MF 74703012

20



DIJELOVI I SKLOPOVI MOTORA

ŠIFRA	NAZIV	sl. 1.	sl. 2.	sl. 3.
04838004046	Sklop motora Deutz (sl. 2 i 3) 3 karike, Ø 100 mm svornjak Ø 35 x 80 mm komora za sagorijevanje Ø 55x15,6 mm			
04838004071	Brtve sklopa motora (kpl) (sl.1)			
Za modele Deutz- Fahr: 6.06, 4.71, 4.78, 6.08, 6.11, 4.07, 6.07, 2506, 3006, 4006, 4506, 5006, 5206, 5506, 6006, 6206, 6806, 7006, 7206, 7506, 8006, 9006, 10006, 12006, 13006, 2807, 3607, 4007, 4507, 4807, 5007, 5207, 6007, 6207, 6507, 6807, 6907, 7007, 7207, 3.10, 3.30, 3.60, 3.65, 3.70, 3.90, 4.10, 6.05, 6.10, 36, 50, 55, 85, 90, 110, 2002, 2003, 2004, 2005, 6.05, Deutz FL912 ke				
04838060096	Sklop motora Fendt (sl. 2 i 3) MWM 3 karike, Ø 105 mm svornjak Ø 35 x 88 mm komora za sagorijevanje Ø 60x21,7 mm			
04838002913	Brtve sklopa motora debljine 1,4 mm tvrde (kpl) (sl.1)			
Farmer 304, Farmer 307, Farmer 308, Farmer 309, Farmer 310, Favorit 509, Favorit 510, Favorit 512, Favorit 514, Favorit 515, Favorit 611, Favorit 612, Favorit 614, Favorit 615 Tip: Farmer 304LS, 304LSA, 307LS, 307LSA, 308LS, 308LSA, 309LSA, 310LSA, Favorit 611LSA, 612LSA, 614LSA, 615LSA, 509, 510, 512, 514, 515				
04838006391	Sklop motora Renault (sl. 2 i 3) 4 karike, Ø 100 mm svornjak Ø 35 x 82 mm komora za sagorijevanje Ø 56x19,1 mm			
04838006061	Brtve sklopa motora debljine 0,85 mm tvrde (kpl) (sl.1)			
04838006060	Brtve sklopa motora debljine 1,15 mm tvrde (kpl) (sl.1)			
Model: 782-4, 551, 556, 600, 650, 750, 751, 752, 754, 781, 782, 800, 804, 850, 854, 900, 904, 1151-4, 1181-4, Ceres 65, Ceres 70, Ceres 85, Ceres 95, 58-12, 58-14, 58-32, 58-34, 61-12, 61-14, 65-12, 65-14, MWM D 226, MWM TD 226, MWM TD 228, 65-32, 65-34, 75-12, 75-14, 75-32, 75-34, 77-12, 77-14, 80-12, 80-14, 85-12, 85-14, 85-32, 85-34, 90-32, 90-34, 95-12, 95-14, 110-14, 110-54, 120-14, 120-54, 133-14, 133-54				
04838019045	Sklop motora Same (sl. 2 i 3) 4 karike, Ø 105 mm svornjak Ø 35 x 80 mm komora za sagorijevanje Ø 59,2x21,8 mm			
04838019036	Brtve sklopa motora (kpl) (sl.1)			
Model: Jaguar 100, Laser 130, Leopard C, Leopard 85, Leopard 90, Mercury 85, Minitaurus 60, Saturno 80, Taurus 60, Trident 130, Vigneron 60, Motor Same 105.3, Motor Same 105.4, Motor Same 105.5, Motor Same 105.6, Buffalo 130, Centurion 75, Drago 120				

20

ŠIFRA	NAZIV	sl. 1.	sl. 2.	sl. 3.
04838012801	Ležajevi za John Deere Ležaj klipa (sl. 1.) standard R525767			
04838012556	Ležaj radilice (sl.2.) standard RE529319			
04838012557	Ležaj radilice bočni (sl.3.) standard RE529320			
04838002971	Ležajevi za MF Ležaj klipa (sl. 1.) standard V836110552			
04838015681	Ležaj radilice (sl.2.) standard V836840944			
04838015682	Ležaj radilice bočni (sl.3.) standard V836840945			



DIJELOVI I SKLOPOVI MOTORA

ŠIFRA	NAZIV	ŠIFRA	NAZIV
04838015705	Glava motora s ventilima traktora MF 3 cilin. 3638321M91 Za modele: 35, 35X, 133, 135 Tip motora: A3.144, A3.152	04838015707	Glava motora s ventilima motora Perkins 4 cilin. 3637384M91 Za motor: AD4.203
04838015504	Ventil usisni MF 731151M1	04838010020	Ventil usisni Same 0.010.6016.0
04838015505	Ventil ispušni MF 731152M1 Za modele: 35, 133, 135 Tip motora: A3.144, A3.152	04838010021	Ventil ispušni Same 0.066.1421.0 Za modele: Dorado, Explorer
04838004068	Uljna pumpa Deutz - navoj 32x2 mm 04234146 Za modele: DX Agro-Compact, Lux, Plus, Prima, Star, Extra	04838015396	Uljna pumpa MF 747292291 Za modele: 399, 699, 1014, 1024, 1114, 2625, 2640, 2645, 3080, 3090, 3610
204139	Čep ulja Za modele: DX Agro-Compact, Lux, Plus, Prima, Star, Extra Tip motora: FL912, FL913, BFL913	048380002160	Čep ulja New Holland Za modele: TS80, 90, 100, 110, 115, TM 115, 125, 130, 135, 140, 150, 155, 165, 175, 190 Tip motora: 675TA
04838012752	Mjerač ulja John Deere	04870815393	Mjerač ulja MF
04838017037	Brtve motora Fiat (kpl) 1940034 Za modele: 65-46, 65-56, 70-56, 65-66, 70-66, 70-76, 70-86, 65-88, 70-88, 65-90, 70-90, 65-93, 72-93, 65-94, 72-94, Motor Fiat/Iveco 045.02, Motor Fiat/Iveco 8045.06, 600, 640, 666, 680	04838012070	Brтва motora John Deere (kpl) RE524748 Za modele: Motor 4219, 4239, 4276, 1640, 1830, 1840, 2020, 2030, 2040, 2120, 2130, 2140, 2250, 2450, 2650, 2850



HIDRAULIČNE PUMPE, LAMELE I CILINDRI KVAČILA















ŠIFRA	NAZIV	ŠIFRA	NAZIV
204477	Hidraulična dvostruka pumpa Renault - izlazni volumen 19+11 - omjer 1:5, Ø 80 25999066	205266	Hidraulična dvostruka pumpa CaselH - izlazni volumen 22,5+16 - 9 zuba Za modele: CS 78, 80, 86, 94, 100 sa Valmet motorom
202343	Pumpa hidraulike lijeva 2TK 14 S DEU - širina 90,30 mm 00815012 Pril	04825912000	Hidraulična pumpa John Deere - izlazni volumen: 28 AL156335 Za modele: 6010, 6020, 6110, 6120, 6130, 6210, 6215, 6220, 6230, 6310, 6320, 6330, 6410, 6415, 6420, 6430, 6510, 6520, 6530, 6610, 6620, 6630, 6830, 6930
204915 195580	Lamela vučna za IMT533 IMT539, 558	202185	Lamela Deutz 26x32 10 utora Za modele: D6006, 6806, 6807, 7006, 7206, 7207, 7807

ŠIFRA	NAZIV	sl. 1.	sl. 2.	sl. 3.
04844506000	Lamela za Fendt Potisna ploča (sl. 1.) 125003621			
04844506001	Lamela kardanska (sl.2.) 26x32 mm ,10 utora			
04844506045	Lamela vučna (sl.3.) 26x32 mm, 10 utora			
Za modele: Farmer 2, Farmer 3, Farmer 4, Farmer 5, Farmer 102, Farmer 103, Farmer 104, Farmer 105, Farmer 106, Farmer 108				
04844507003	Lamela Fiat (kpl) (sl.1) 35x40 mm, 14 utora			
04844507005	5121604 Lamela vučna Fiat (sl. 3.) 22x25 mm, 10 utora			
Za modele: 55-46, 60-46, 65-46, 55-56, 60-56, 65-56, 70-56, 55-66, 60-66, 65-66, 70-66, 80-66, 72-86, 82-86, 55-88, 60-88, 65-88, 70-88, 80-88, 55-90, 60-90, 65-90, 70-90, 80-90, 85-90, 72-93, 82-93, 88-93, 60-94, 72-94, 82-94, 88-94, 500, 540, 550, 566, 580, 600, 640, 666, 670, 680, 740, 766, 780				

ŠIFRA	NAZIV	ŠIFRA	NAZIV
04870804392	Cilindar kvačila za Deutz 04369687	04870806196	Cilindar kvačila za Fendt G198100100030
04870804393	Set za cilindar kvačila Deutz 04369689	04870806197	Set za cilindar kvačila Fendt Ø 20 mm



KOČNICE I ISPUŠNI SUSTAV

ŠIFRA	NAZIV	ŠIFRA	NAZIV
04871704020	Kočione pločice za Deutz 71x19x90 mm par 04381403 Za modele: DX, AgroPrima, AgroExtra	04871704012	Kočiona obloga za doboš traktor Deutz 04379102
		04871704027	Doboš za traktor Deutz Ø 250 mm 03393285 Za modele: DX
			
204221 205534	Kočione pločice za CaseIH, Fendt, Steyr 90x15x71 mm 135700441804	204767	Kočione pločice za Fendt 98x15x68 mm F385103070010 Za modele: Favorit 611, 612, 614, 615
			
04871706214	Disk kočnica za Fendt 385100070010 Za modele: Favorit 611, 612, 614, 615	04871715000	Kočiona obloga za MF Ø 165 mm, 13 utora, debljina 13 mm 1823112M92 Kočioni disk (škare) za MF Ø 165 mm 1822606M92 Za modele: 5500, 5840, 6500, 6550, 6840, 7500, 7550, 8500, 8550
			
04871718035	Glavno kočioni cilindar John Deere RT7700021476	04871715034	Glavni kočioni cilindar za MF 3614780M91 Za modele: 342, 352, 362, 365, 372, 375, 382, 390, 396, 398, 399
			
04871718040	Kočioni cilindar kotača za John Deere i Renault RT0011453340	04871715035	Set za glavni kočioni cilindar za MF 1811086M91 Za modele: 342, 352, 362, 365, 372, 375, 382, 390, 396, 398, 399
			
ŠIFRA	NAZIV	ŠIFRA	NAZIV
04838012038	Ispušni lonac za John Deere - izl. priključak Ø 65 mm AL31492	04838004013	Ispušni lonac za Deutz duljina 1130 mm priključak 45/53 mm 04346150
			
04838012045	Ispušna cijev za John Deere Ø 65 mm duljina 1050 mm AL34694	04838099007	Poklopac ispušne cijevi 40-43, 44-47, 48-51, 52-55, 56-59, 60-63, 64-67, 67-73, 70-76, 74-79, 76-83, 80-85, 86-91, 92-97, 95-98
			



ANLASERI

Tipovi anlasera

3 rupe **LIJEVI** smjer

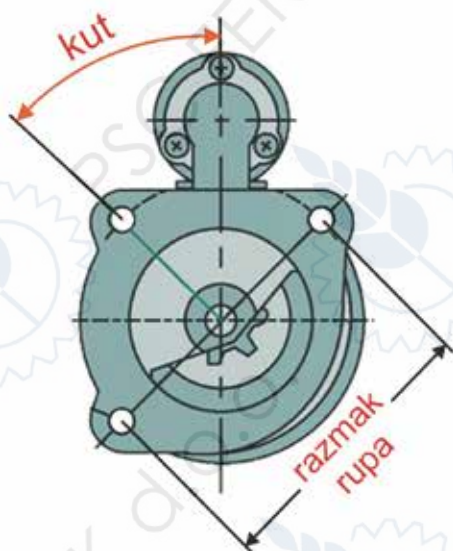

2 rupe **DESNI** smjer

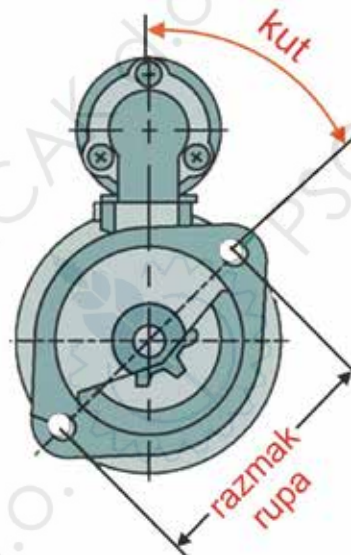

Podaci u tablici služe kako bi ste lakše odredili vrstu anlasera koju trebate za svoj stroj.

Podaci	Moguće vrijednosti
Kut kretanja	30° - 35° - 40° - 45° - 60°
Smjer (provjeriti)	Lijevo (L) - Desno (D)
Broj zubi rotora (izbrojiti)	9 - 10 - 11
Kopčanje (broj rupa izbrojiti)	2 rupe - 3 rupe
Razmak rupa (mm)	105 - 127 - 146
Snaga (kW)	2,1 - 2,7 - 2,8 - 3 - 3,1 - 4
Napon (V)	12 - 24

ŠIFRA	Naziv	Za modele	Napon (V)	Snaga (kW)	Broj zuba	Smjer kretanja	Razmak rupa (mm)	Kut (°)	Broj rupa
048379IS0704	Anlaser	CaselH	12	3,1	9	L	127	45	3
048379IS0201	Anlaser	Deutz	12	3	11	D	105	35	2
048379IS0203	Anlaser	Fiat	12	2,7	9	L	146	60	3
048379IS0569	Anlaser	John Deere	12	3,1	9	L	127	45	3
048379S0004	Anlaser	MF	12	2,8	10	L	127	40	3
048379IS0179	Anlaser	Zetor	12	3	11	D	127	45	3





ALTERNATORI

Tipovi alternatora



ŠIFRA	Naziv	Za modele	Napon (V)	Struja (A)	Tip (slika)	Kopčanje L/d/R (mm)	Remenica Ø (mm)	Udaljenost do remenice (mm)	Kut spajanja (°)
048379IA0463	Alternator	CaseIH	14	65	1	67/12,2/85	bez	-	0
048379IA0096	Alternator	Deutz	14	33	2	56/8,2/86	68	21	L60
04837960023	Alternator	Fendt	14	80	3	56/8,2/86	68	20,9	+R60
048379IA1541	Alternator	John Deere	14	95	2	2x56/10,2/90	bez	-	L60
04837950015	Alternator	MF	14	70	4	56/8,2/86	bez	-	L60
205308	Alternator	New Holland	14	65	3	56/8,2/86	68	9,7	+R60
205307	Alternator	CaseIH, Deutz, Fendt, John Deere	14	33	2	56/8,2/86	65	9,7	L60

Remenice alternatora

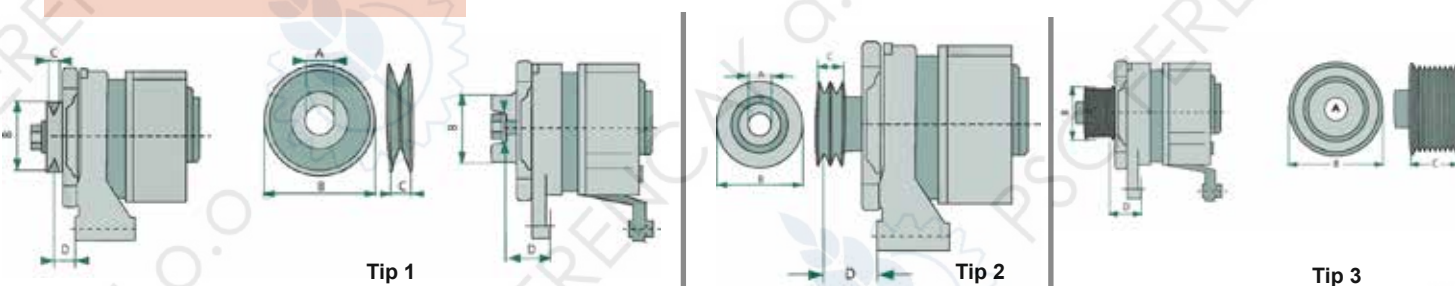

20

ŠIFRA	Naziv	A (mm)	B (mm)	C (mm)	D (mm)	Tip remenice	Tip remena*
04837916905443	Remenica alternatora	17	62	14	19,6	1	SPZ
04837916906308	Remenica alternatora	17	68	14	20,9	1	SPZ
04837916908434	Remenica alternatora	17	74	37	40,4	2	2xSPA
04837916906325	Remenica alternatora	17	81	28	32,5	2	2xSPZ
04837916908703	Remenica alternatora	17	50	25,5	27,1	3	6 utora
04837916906719	Remenica alternatora	17	55	34,5	26,8	3	8 utora

* Vidjeti tipove remena u poglavlju 16. Remeni

**ELEKTRIČNA INSTALACIJA**

ŠIFRA	NAZIV	ŠIFRA	NAZIV
199821 199822 199823	Start kabeli 16 mm ² 25 mm ² 35 mm ²	202200	Sigurnosna sklopka max. 12- 24 V - opterećenje: - max.500 A
190509 190508	Start kabeli 25 mm ² 35 mm ²	195596 200065	Brava za paljenje IMT na stopice Brava za paljenje
190392 190393	Klema (+) Klema (-)	192226 204014 040467	Kontakt brava i brava svjetla uklj./kratka/duga na stopice i vijke IMT Zetor tropolna Zetor na vijke
190858	Bakreno uže za masu 21,2 mm ² L=500 mm	195590 040522	Prekidač žmigavaca IMT Prekidač Zetor
50752287030	Bakreno uže akumulatora (s klemom) 21,2 mm ² duljina 300 mm duljina 350 mm duljina 400 mm duljina 500 mm	04850760117	Prekidač za svjetla za Fendt pozicijska svjetla,radno svjetlo (kratko, dugo)

20

**Sve potrebne dijelove za Vaš traktor naručujemo prema Vašim zahtjevima u roku 48 sati.
Vaše upite i narudžbe možete uputiti:**

- telefonom našim trgovinama
- putem web shopa
www.psc-ferencak.hr
- putem e-maila
info@psc-ferencak.hr





SVJETLA

ŠIFRA	NAZIV	ŠIFRA	NAZIV
198760	Lampa prednja Ford, horizontalno postavljanje žarulja: 12V; 40/45WAS 12V4WK/T4W	700870311017	Lampa prednja za Belarus vertikalna, metalno kućište žarulja: 12V, 45/40W/R2 halogen ili 12V, 45/40WAS i 12V4WK/T4W
202499	Lampa prednja za Fendt L/D ugradbena, Ø 90 mm - 4 točke pričvršćivanja - žarulja 12V; 55W H7	204930	Lampa prednja za IMT Ø 115 mm - horizontalni priključak - žarulje 12V; 40/55W šušir 12V; 2W
205642	Lampa prednja sa žmigavcem ugradbena za Fendt L - žarulje: 12V; 60/55W H4 12V; 4W T4W 12V; 21W R21W kopčanje 2xM8	205630	Lampa prednja sa žmigavcem ugradbena za Fendt D i L - žarulje: 12V; 60/55W H4 12V; 4W T4W 12V; 21W R21W kopčanje 2xM8
205019	Lampa radna reflektor H3 okrugla 12V; 55W H3	202192	Lampa radna reflektor diguzni H3 četvrtasta 12V; 55W H3 - razmak rupa 110 mm
205644	Lampa radna Hella 148x84 mm 12V; 55W H3 ili 24V; 70W H3	203249	Radna lampa okrugla s kablom duljine 500 mm 12V; 55W H3
202398	Radna lampa ugradbena Hella - žarulja 12V; 55W H3 - pričvršćivanje u 4 točke vijak 3,9x13 mm - razmak rupa 80 mm	205631	Radna lampa Hella četvrtasta domet cca 50 m priključak 250 mm 12V; 55W H3 - kut 5-15°
205632	Radna lampa Hella četvrtasta priključak 250 mm 2x12V; 55W H3 ili 2x24V; 70W H3 - kut 5-20°	205288	Radna lampa za montažu na kabinu 12V (žarulje nisu zamjenjive)

20

Za sve upute i dodatne narudžbe se možete izravno obratiti našim poljoprivredno-servisnim centrima ili poslati upit putem elektroničke pošte na adresu

info@psc-ferencak.hr

Stojimo Vam na raspolaganju!

**LED SVJETLA I SIGNALIZACIJA**

ŠIFRA	NAZIV		ŠIFRA	NAZIV	
202629 203734 205210	Lampa radna četvrtasta LED 12V 1200 lm (Lumena) 1800 lm 2200 lm		203736	Lampa radna pravokutna LED 12V 1200 lm	
203735 205211	Lampa radna okrugla LED 12V 1800 lm 2200 lm 27W		70799128	Lampa radna LED 12/24V 27W 9xLED visokog sjaja 1900 lm	
203255 203254	Lampa zadnja mala žmigavac 12V/21W P21W pozicija/stop 12V/21/5W Desna Lijeva		204473	Lampa zadnja MF, Case žmigavac 12V/21W P21W pozicija/stop 12V/21/5W	
191319L 191319D 205102 201085	Zadnja lampa pozicija/stop 12V/21/5W žmigavac 12V/21W P21W Lijeva Desna Desna Hella Lijeva Hella		040495	Lampa zadnja mala IMT 533 žmigavac 12V/21W P21W pozicija/stop 12V/21/5W	
193327	Lampa zadnja kosa D/L žmigavac 12V/21W P21W pozicija/stop 12V/21/5W		193908	Lampa žmigavac pozicija kosa žmigavac 12V/21W P21W pozicija 12V/5W	
198759	Lampa pozicija žmigavac ugradbena D/L žmigavac 12V/21W P21W pozicija 12V/5W		040515	Lampa zadnja Fiat D/L žmigavac 12V/21W P21W pozicija 12V/5W	
203262	Svjetlo za osvjetljavanje tablice LED - kabel 200 mm 12V/24V 2xLED		203058	Svjetlo za vožnju unatrag 12V/21W 87x77x56 mm	
203257	Stražnje svjetlo za maglu 12V/21W		100156	Lampa prikolica 100x93x45 širina pričvrtnih vijaka žmigavac 12V/21W P21W pozicija/stop 12V/21/5W	

20



LED SVJETLA I SIGNALIZACIJA

ŠIFRA	NAZIV	ŠIFRA	NAZIV
205183 203802	Zadnja lampa žmigavac 12V/21W P21W pozicija/stop 12V/21/5W unatrag 12V/5W Lijeva Desna	204546	Lampa žmigavac D/L 12V; 21W
203251 203250	Lampa blatobrana prednja za Case IH žmigavac 12V/21W pozicija 12V/10W R10W Desni Lijevi	203946	Lampa stražnja L žmigavac 12V/21W stop/pozicija 12V/21W/5W svjetlo za maglu 12V/10W
200209	Lampe za prikolicu na magnet s kablom duljine 7,5m i 7-polnim utikačem žmigavac 12V/21W stop/pozicija 12V/21W/5W	205160 205161	Lampa stražnja za Fendt žmigavac 12V/21W pozicija 12V/10W Lijeva Desna
205293	Ploča sa stražnjim svjetlima i kablom duljine 4m i 7-polnim utikačem širina ploče 120 mm	198541	Rotirka nasadna 12V/24V 21W
191988	Rotirka 12V na magnet s dvopolnim priključkom 12V	205185	Rotirka 12V/24V s fiksnim prihvatom na vijak
202627	Rotirka nasadna 12V/24V LED	199769	Rotirka nasadna 12/24V 21W
205564	Rotirka nasadna gibljiva 12V; 21W 24V; 21W	198541	Rotirka nasadna gibljiva 12V
201165	Staklo rotirke Za modele: 191988	205555	Staklo za rotirku Za modele: 199769



DRŽAČI ROTIRKI

ŠIFRA	NAZIV	ŠIFRA	NAZIV
203360	Nosač rotirke ravni	198426	Nosač rotirke okomiti s dvije rupe razmak 84 mm
198424	Nosač rotirke nasadni	198425	Nosač rotirke okomiti s dvije rupe razmak 80 mm
202432	Nosač rotirke bočni preklopni	200212	Nosač rotirke bočni s dvije rupe
199216	Nosač rotirke okomiti s maticom	202528	Nosač rotirke krovni preklopni s dvije rupe

Stopica i alat za spajanje

ŠIFRA	NAZIV	ŠIFRA	NAZIV
203291	Set stopica 270 kom u kutiji za vodič 0,5-1 mm ²	203292	Set stopica 60 kom u kutiji - klješta za krimpanje - klješta s dugačkim čeljustima - 2 odvijača - ispitivač 6-24 V - izolirana žica 1m - izolacijska traka
203290	Set stopica 270 kom u kutiji za vodič 1,5-2,5 mm ²		
199191	Stopica mesing Ž s kukicom 1,5-2,5 mm ² ; 6,3 mm	203804	Stopica mesing M s kukicom 1,5-2,5 mm ² ; 6,3 mm

20



ŽARULJE



1



2



3



4



5



6



Izgled podnožja za BA i BAY tipove žarulja

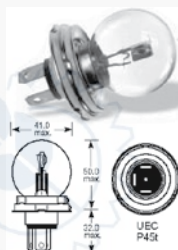

7



8



9

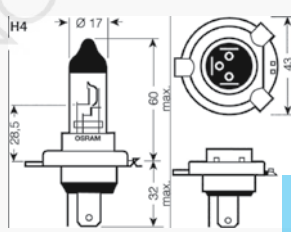

10



11

ŠIFRA	NAPON (V)	SNAGA (W)	NAMJENA	OZNAKA PRIKLJUČKA	SLIKA BR.
	12	2	Pozicijsko svjetlo prednje, blatobran, gabaritno svjetlo	BA 9s	1
190521	12	3	Pozicijsko svjetlo prednje, blatobran, gabaritno svjetlo	BA 9s	1
205300	12	4	Pozicijsko svjetlo prednje i blatobran	BA9s	1
190397 190519	12	5	Pozicijsko svjetlo stražnje i registracija, vožnja unatrag	BA15s	2
		5	Žmigavci	SV8,5	3
205305	12	10	Žmigavci	SV8,5	3
	12	21	Žmigavci	BAU15s	4
205303	12	21	Žmigavci	Bau15s	5
	12	21	Stražnje svjetlo za maglu, stop svjetlo	BA15d	5
205304 040160	12	21/5	Stražnje pozicijsko svjetlo/stop svjetlo	BAY15d	6
040158	12	40/55	Prednje svjetlo dugo/kratko	P45t	7
040412 205298	12	55/60	Prednje svjetlo dugo/kratko H4	P43t-38	8
205296	12	55	Prednje svjetlo kratko H1	P14,5s	9
205297	12	55	Prednje svjetlo kratko H3	PK22s	10
205299	12	55	Prednje svjetlo dugo H7	PX26d	11

20



UTIČNICE, UTIKAČI I OSIGURAČI

ŠIFRA	NAZIV	ŠIFRA	NAZIV
196561 203275	Utičnica dvopolna 6V-24V	197455 203274	Utikač dvopolni Utikač trolezni okrugli
194181 201860 203277 203279	Utičnica trolezna Utičnica trolezna ,12/24V; 2x25A Utičnica trolezna okrugla	194180 203276	Utikač trolezni
100139 203283 203282	Utičnica 7-polna Utičnica 7-polna ALU Utičnica 7-polna PVC	050117 040517 201991 203281 203280	Utikač 7-polni Utikač 7-polni ALU Utikač 7-polni ALU Utikač 7-polni PVC
198450 203285	Utičnica 13-polna 12V Utičnica 13-polna 12V PVC	198451 203284	Utikač 13-polni 12V Utikač 13-polni 12V PVC
199589	Utičnica upaljača 12V		Utikač 6 polni 6x0,5 mm ² -1 mm ² za svjetlo 205630

OSIGURAČI

20**Tip STANDARD**

ŠIFRA	BOJA	STRUJA (A)
203308		7,5
203309		10
203310		15
203311		20
203312		25
203313		30

**Tip MINI**

ŠIFRA	BOJA	STRUJA (A)
203297		5
		7,5
		10
		15
		20
		25
		30

**Tip STARIJI**

STRUJA (A)	BOJA	BOJA	STRUJA (A)
25A			25A
8A			16A
8A			16A
8A			16A
5A			10A



TROKUTI ZA SIGNALIZACIJU, KATADIOPTERI I NALJEPNICE PRIKLJUČNIH VOZILA

ŠIFRA	NAZIV	ŠIFRA	NAZIV
198067	Trokut s nosače za spora vozila	100422	Katadiopter okrugli narančasti Ø 60 mm
198026	Trokut bez nosača		
100318	Katadiopter trokut	100421	Katadiopter okrugli bijeli Ø 60 mm
100140	Katadiopter okrugli crveni Ø 60 mm		
		198488	Naljepnica ograničenja brzine pravokutna 30 km
		198487	Naljepnica ograničenja brzine okrugla 25 km
		198793	Naljepnica ograničenja brzine okrugla 50 km

Video nadzor za poljoprivredne strojeve

199016 kut 110°
199017 kut 150°



Optimalna mjesta za ugradnju video nadzora na poljoprivrednim strojevima.

20





Upute za spajanje priključaka za priključna vozila



7-polni priključak za male teretne prikolice (utičnica)

Ovaj priključak je poznat i pod oznakom 7 pin 12N (normal) odnosno ISO 1724:2003. Sadrži minimum koji osigurava propisnu signalizaciju na malim teretnim prikolicama: lijevi i desni pokazivač smjera, stop svjetlo i pozicijsko svjetlo. Predviđeno je i svjetlo za maglu koje nije obvezno. Ako je u plastičnom kućištu onda je ovaj priključak crne boje.

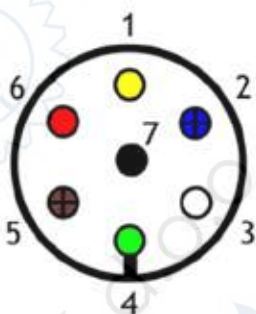

Kontakti 2, 5 i 7 su muški.

- 1 – lijevi pokazivač smjera (žuta)
- 2 – svjetlo za maglu (plava)
- 3 – masa (bijela)
- 4 – desni pokazivač smjera (zelena)
- 5 – desno pozicijsko svjetlo (smeđa ili siva)
- 6 – stop svjetlo – kočnica (crvena)
- 7 – lijevo pozicijsko svjetlo (crna)

13-polni EURO priključak (utičnica)

Ovo je novi standard koji obuhvaća sve potrebe za signalizacijom na prikolici. Poznat je pod oznakom 13 pin euro-plug odnosno ISO 4091:2003. Preporuka je da se na nova vozila i prikolice ugrađuje ovaj priključak.

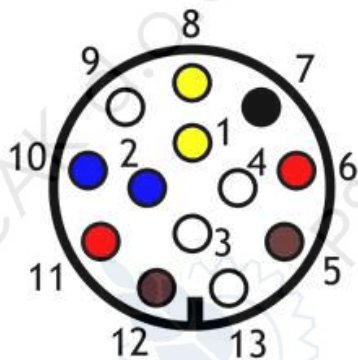

- 1 – lijevi pokazivač smjera (žuta)
- 2 – svjetlo za maglu (plava)
- 3 – masa 35A (bijela)
- 4 – desni pokazivač smjera (zelena)
- 5 – desno bočno pozicijsko svjetlo (smeđa)
- 6 – stop svjetlo – kočnica (crvena)
- 7 – lijevo bočno pozicijsko svjetlo (crna)
- 8 – svjetlo za vožnju unazad (žuta)
- 9 – trajno napajanje +12V (zelena)
- 10 – napon preko kontakt brave (plava)
- 11 – masa 35A (crvena)
- 12 – povezane prikolice (crna)
- 13 – masa 35 A (bijela)

Napomena

Crteži i oznake konektora su dati u odnosu na prednju (vanjsku) stranu priključka na vozilu, odnosno u odnosu na zadnju (unutarnju) stranu priključka na prikolici.

Priključci imaju zub koji osigurava da se utikač ne može ubosti u utičnicu pogrešno.

Boje vodiča su dane prema standardu, ali neki proizvođači koriste druge boje vodiča. Zato uvijek treba provjeriti kontakte prije povezivanja.

Prilikom izvođenja instalacija koristiti vodiče promjera 2.5mm². Za trajno napajanje i masu koristiti vodiče promjera 4 mm². Trajno napajanje obavezno mora ići preko osigurača. Svijetlo za registarsku pločicu mora se napajati sa lijevog pozicijskog svijetla. Ako priključak ima odvojena napajanja i mase za različite namjene onda ih ne treba drugačije koristiti ili spajati. Za neke prikolice je obavezno da postoji zvučni signal prilikom kretanja unazad, kao i obaveza da vozač ima zvučnu ili vizualnu kontrolu da je signalizacija na prikolici ispravna.

Ovi priključci su namijenjeni za vozila s napajanjem od 12V. Za vozila sa napajanjem od 24V koriste se drugačiji priključci.



Prostor za bilješke





SUSTAV KOPČANJA I VUČE

TRI TOČKE SPAJANJA

TOPLING POLUGE HIDRAULIČKE

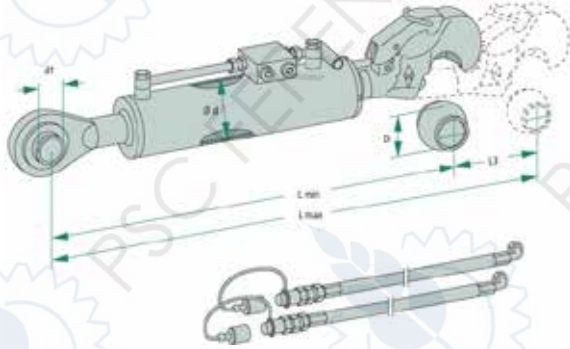

ŠIFRA	NAZIV	Lmin (mm)	Lmax (mm)	D (mm)	d (mm)	d1(mm)	L3 (mm)	Promjer klipa (mm)	Za traktore snage do (ks)
196252	Hidr. topling cat. 2	567	747	50	63	25,4	180	35	90
196352	Hidr. topling cat. 2	617	847	50	63	25,4	230	35	90
196230	Hidr. topling cat. 3	626	836	50	70	25,4	210	35	140
196231	Hidr. topling cat. 3	626	836	60	70	32,2	210	35	140
196232	Hidr. topling cat. 3	666	916	50	70	25,4	-	35	140
196233	Hidr. topling cat. 3	666	916	60	70	32,2	-	35	140

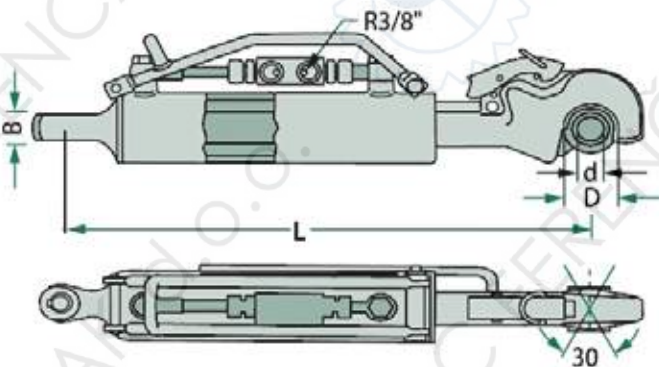

ŠIFRA	NAZIV	Lmin (mm)	Lmax (mm)	D (mm)	d (mm)	Priključak crijeva	Hod (mm)	Promjer klipa (mm)	Za traktore snage do (ks)
196024	Hidr. topling cat. 2	553	783	50	25,4	3/8"	230	36	100
195088	Hidr. topling cat. 3	562	747	60	32,2	3/8"	185	40	200
194977	Hidr. topling cat. 3	602	852	60	25,4	3/8"	250	36	140

20

TOPLING POLUGE HIDRAULIČKE

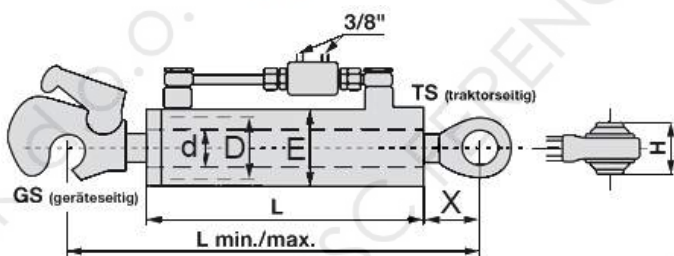

ŠIFRA	NAZIV	Lmin (mm)	Lmax (mm)	D (mm)	d (mm)	E (mm)	Hod (mm)	TS (mm)	Za traktore snage do (ks)
192836	Hidr. topling cat. 3	660	938	80	40	90	278	25,4	140



SUSTAV KOPČANJA I VUČE

TOPLING POLUGE HIDRAULIČKE

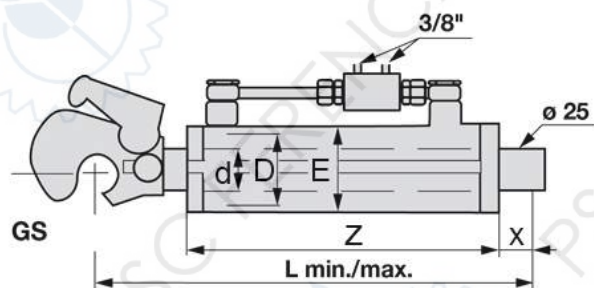

ŠIFRA	NAZIV	Lmin (mm)	Lmax (mm)	D (mm)	d (mm)	E (mm)	Hod (mm)	GS (mm)	Za traktore snage do (ks)
192836	Hidr. topling cat. 3	527	707	90	45	105	180	60/32,2	160
040483	Hidr. topling cat. 3	570	790	80	40	95	220	60/32,2	140
197577	Hidr. topling cat. 3	607	867	80	40	95	260	60/32,2	140
198538	Hidr. topling cat. 3	700	940	90	45	105	240	60/32,2	160

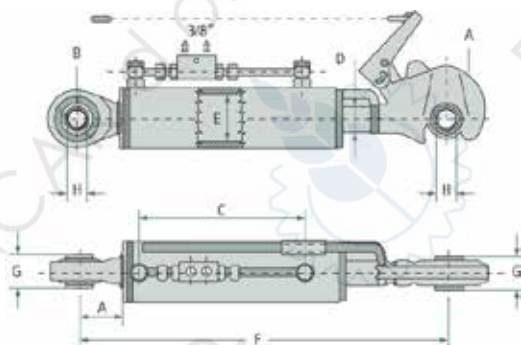

ŠIFRA	NAZIV	Lmin (mm)	Lmax (mm)	D (mm)	C (mm)	E (mm)	H(mm)	G (mm)	Za traktore snage do (ks)
199761	Hidr. topling cat. 2	570	790	35	220	70	25,4	51	100
192835	Hidr. topling cat. 2	640	850	35	-	63	25,4	51	100

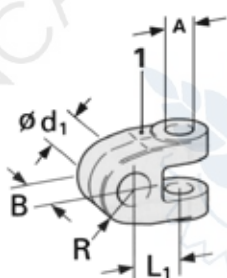

ŠIFRA	NAZIV	A (mm)	B (mm)	L1 (mm)	R (mm)	d1 (mm)
196837	Glava top. poluge	20	44	46,5	26	22,2
197016	Glava top. poluge	20	44	46,5	26	25,7
196838	Glava top. poluge	25	50	63	35	28,2
194978	Glava top. poluge	25	50	63	35	32,2
195206	Glava top. poluge	25	50	63	35	35,2
195089	Glava top. poluge	25	50	100	35	35,2

193122	Kocka ventil poluge
196125	Crijevo top. poluge



20



SUSTAV KOPČANJA I VUČE

TOPLING POLUGE MEHANIČKE

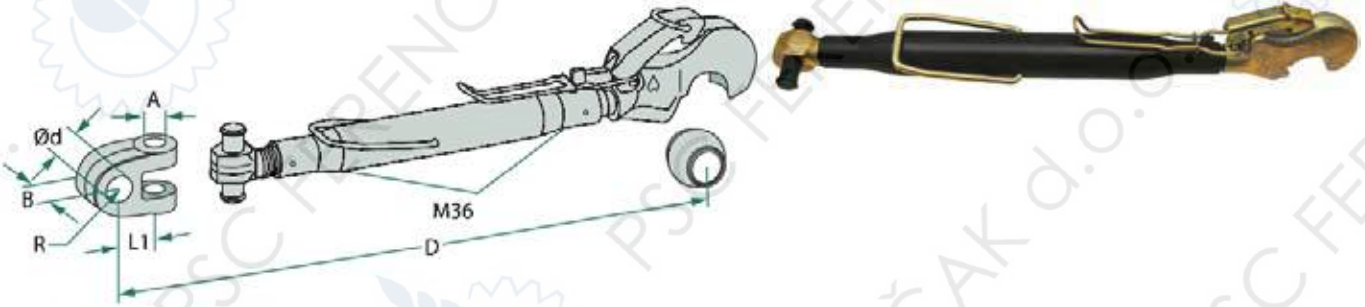

ŠIFRA	NAZIV	Lmin (mm)	Lmax (mm)	Navoj (mm)	Svornjak Ø (mm)	Za traktore snage do (ks)
194551	Hidr. topling cat. 2	510	740	M30x3,5	20	100
197565	Hidr. topling cat. 3	625	855	M36x3,5	25	185
194552	Hidr. topling cat. 3	665	975	M36x3,5	25	185

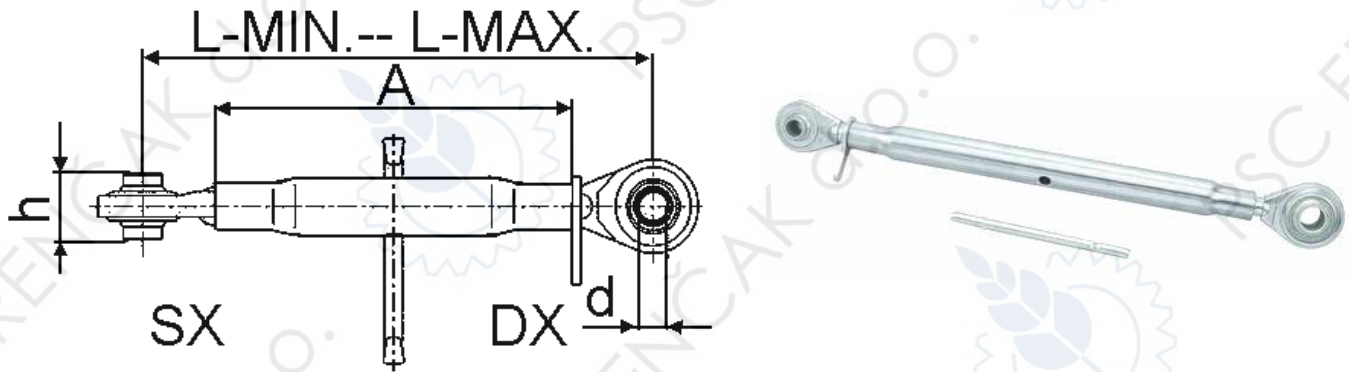

ŠIFRA	NAZIV	Lmin (mm)	Lmax (mm)	Navoj (mm)	A (mm)	d (mm)	h (mm)
100249	Meh. topling cat. 1	540	75	M27x3	430	19	44
196377	Meh. topling cat. 1	680	890	M27x3	570	19	44
100452	Meh. topling cat. 1/2	585	810	M27x3	470	19/25,4	44/51
190529	Meh. topling cat. 2	580	830	M30x3	460	25,4	51
194194	Meh. topling cat. 3	650	970	M40x3	500	32,2	51
194195	Meh. topling cat. 3	770	1090	M40x3	620	32,2	51

20



ŠIFRA	NAZIV	Lmin (mm)	Lmax (mm)	Navoj (mm)	A (mm)	d (mm)	h (mm)
192163	Meh. topling cat. 2	550	780	M27x3	430	25,4	51
191718	Meh. topling cat. 3	615	900	M36x3	460	32,2	51



SUSTAV KOPČANJA I VUČE

TOPLING POLUGE MEHANIČKE

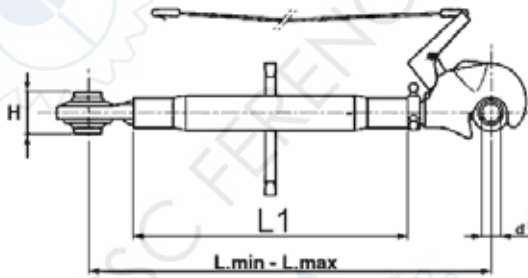

ŠIFRA	NAZIV	Lmin (mm)	Lmax (mm)	Navoj (mm)	L1 (mm)	d (mm)	h (mm)
198727	Meh. topling cat. 3	740	1060	M36x3	520	32,2	51

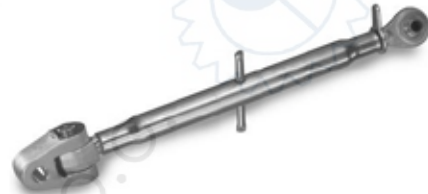
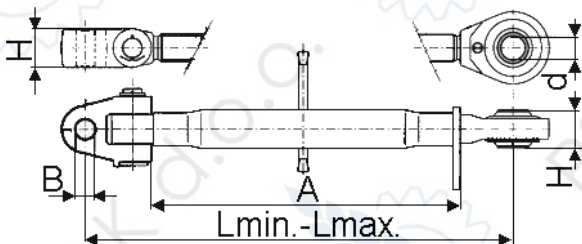

ŠIFRA	NAZIV	Lmin (mm)	Lmax (mm)	Navoj (mm)	L1 (mm)	d (mm)	B (mm)
191717	Meh. topling cat. 3	695	960	M36x3	520	32,2	32,2

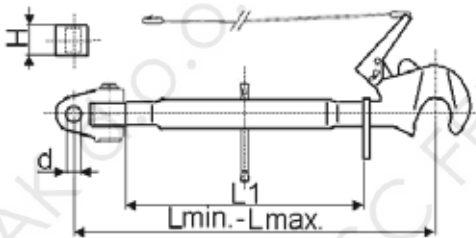

ŠIFRA	NAZIV	Lmin (mm)	Lmax (mm)	Navoj (mm)	L1 (mm)	d (mm)	h (mm)
198709	Meh. topling cat. 2	670	935	M36x3	450	25,4	51

DIJELOVI I PRIBOR ZA TOPLING POLUGE



20

ŠIFRA	NAZIV	ŠIFRA	NAZIV
197508	Čahura poluge M36x3 L=255 mm	199043	Čahura poluge M30x3,5 L=405 mm
196688	L=370 mm	198422	L=510 mm
196930	L=400 mm	196897	L=950 mm
198456	L=460 mm		
196787	L=500 mm		
196692	L=580 mm		
196857	L=660 mm		
197221	Čahura poluge M30x3 L=400 mm	196788	Čahura poluge M36x3 L=360 mm
196727	L=450 mm	197962	L=400 mm
197269	L=500 mm		
197220	L=600 mm		



SUSTAV KOPČANJA I VUČE

DIJELOVI I PRIBOR ZA TOPLING POLUGE

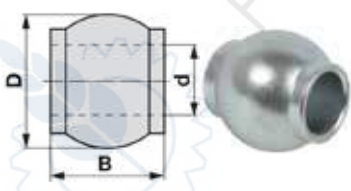
ŠIFRA	NAZIV	ŠIFRA	NAZIV
	Čahura poluge M40x3		Matica toplinga
197963	L=400 mm	050194	M30x3,5
197961	L=520 mm	196998	M30x3,5
		196759	M36x3
		190614	M40x3
	Kugla topling poluge		Matica toplinga
194172	Kat. 2 25,4/50 mm	197616	M27x3
192824	Kat. 2/3 25,4/60 mm		
195691	Kat. 3 32,5/60 mm		
			

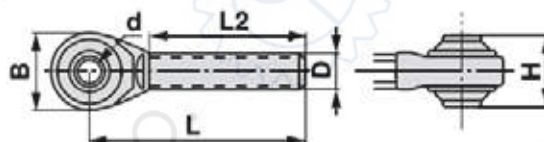
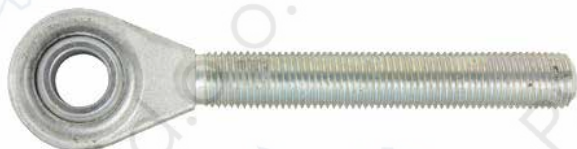

ŠIFRA	NAZIV	Kat.	L (mm)	L2 (mm)	Navoj D (mm)	d (mm)	H (mm)	B (mm)
197614	Oko toplinga sa navojem desni	2	241	185	M27x3	25,4	42	66
197615	Oko toplinga sa navojem lijevi	2	241	185	M27x3	25,4	42	66
196728	Oko toplinga sa navojem desni	2	230	170	M30x3	25,4	51	75
196729	Oko toplinga sa navojem lijevi	2	230	170	M30x3	25,4	51	75
197721	Oko toplinga sa navojem desni	2	230	170	M30x3,5	25,4	51	75
197723	Oko toplinga sa navojem lijevi	2	230	170	M30x3,5	25,4	51	75
196728	Oko toplinga sa navojem desni	2	235	180	M30x3	25,4	51	75
196729	Oko toplinga sa navojem lijevi	2	235	180	M30x3	25,4	51	75
197721	Oko toplinga sa navojem desni	2	220	165	M30x3,5	25,4	51	75
197723	Oko toplinga sa navojem lijevi	2	220	165	M30x3,5	25,4	51	75
196898	Oko toplinga sa navojem desni	3	220	165	M30x3,5	32,2	51	85
196899	Oko toplinga sa navojem lijevi	3	220	165	M30x3,5	32,2	51	85
196689	Oko toplinga sa navojem desni	2	270	200	M36x3	25,4	51	95
196716	Oko toplinga sa navojem lijevi	2	270	200	M36x3	25,4	51	95
196691	Oko toplinga sa navojem desni	3	270	200	M36x3	32,2	51	95
196690	Oko toplinga sa navojem lijevi	3	270	200	M36x3	32,2	51	95
197967	Oko toplinga sa navojem desni	2	240	180	M40x3	25,4	51	85
197966	Oko toplinga sa navojem lijevi	2	240	180	M40x3	25,4	51	85
197965	Oko toplinga sa navojem desni	3	250	180	M40x3	32,2	51	95
197964	Oko toplinga sa navojem lijevi	3	250	180	M40x3	32,2	51	95

ŠIFRA	NAZIV	Kat.	A (mm)	B (mm)	C (mm)	Navoj
190112	Brzo kopčanje toplinga desni	2	50	110	170	M27x3
192367	Brzo kopčanje toplinga desni	3	65	150	170	M36x3
100420	Brzo kopčanje toplinga lijevi	3	65	150	170	M36x3



ŠIFRA	NAZIV	Kat.	A (mm)	B (mm)	C (mm)	Navoj	Ø (mm)	H (mm)
194031	Oko poteznice s navojem desni	2	105	65	190	M36x3	25,4	51
196813	Oko poteznice s navojem desni	3	105	65	190	M36x3	32,2	51
198490	Oko poteznice s navojem desni	3	105	65	190	M36x3	37,2	51

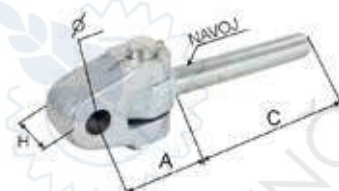



SUSTAV KOPČANJA I VUČE

DIJELOVI I PRIBOR ZA TOPLING POLUGE, KUKE S AUTOMATSKIM KOPČANJEM I KUKE BRZOG KOPČANJA

ŠIFRA	NAZIV	ŠIFRA	NAZIV
196797	Oko toplinga za varenje 	194561 194289	Set za brzo kopčanje Kat. 2 do 100 ks Kat. 3 do 200 ks 
198749 192826 195052 195053	Kugla DxdxB 56x22,2x35 mm 56x28,5x45 mm 64x28,5x45 mm 64x37,5x45 mm 	194924 194923 198702	Osigurač kuke brzog kopčanja Kat. 2 Kat. 3 Kat. 4 
193323 192661 192823	Kugla DxdxD2 56x28,5x12 mm 64x28,5x12 mm 64x37,5x16 mm 	198726 200952 205295	Kuka brzog kopčanja Kat. 2/3 Kat. 3 Kat. 2S CBM 
193549 192954	Osigurač kugle Ø 11 mm Ø 15 mm 	199590	Kuka brzog kopčanja na vijak za prednji hidraulik 
198807	Kuka brzog kopčanja Kat. 2 	197867 198752	Nastavak poluge hidraulika za varenje Ø 22,1 mm Ø 28,4 mm 
194522 194984 194523 194524	Kugla DxdxØ 56x28,7x12 mm 64x28,7x12 mm 64x37,3x12 mm 64x37,3x17 mm 	198728 198729	Lanac stabilizatora M20, L=460, Ø =12 mm M20, L=670, Ø =12 mm 
195166 195167	Čahura BxAxCxD mm 28x22,4x63x12,5 36,5x28,4x63x12,5 	198323 190563 198750	Klin treće točke Ø19 mm, L=127 mm Ø22 mm, L=202 mm Ø25 mm, L=161 mm 
194982 194983 196839	Kugla BxAxC 56x28,7x45 mm 64x28,7x45 mm 64x37,3x45 mm 	197820	Klin vuče 



SUSTAV KOPČANJA I VUČE

DIJELOVI I PRIBOR ZA TOPLING POLUGE I KOPČANJE

ŠIFRA	NAZIV		ŠIFRA	NAZIV	
191921 191826 191920 196855	Klin treće točke Ø 19/19 mm, L=210 mm Ø 19/25 mm, L=168 mm Ø 22/22 mm, L=210 mm Ø 28/36 mm, L=290 mm		198355 198530 193704	Klin vuče Ø 19 mm, L=185 mm Ø 28 mm, L=140 mm Ø 28 mm, L=185 mm	
197104 197103	Klin treće točke povinuti Ø22/28 mm, L=140, L2=170 mm Ø25/32 mm, L=150, L2=150 mm		192377 192378	Klin treće točke Ø 19 mm, L=180 mm Ø 22 mm, L=180 mm	
197948	Klin vuče		198324 198325	Osigurač preklopni sigurnosni Ø 10,5 mm, L=55 mm Ø 11,5 mm, L=75 mm	
198332	Klin vuče		192832 100187 100188 100190	Osigurač preklopni Ø 5 mm, L=35 mm Ø 6 mm, L=36 mm Ø 8 mm, L=36 mm Ø 11 mm, L=40 mm	
190526 198550 193064 197681 198751	Nosač stroja LxDxD2xD3xL4		199218 195818 194174	R-osigurač Ø 4 mm Ø 5 mm Ø 6 mm	
192662 198459	Nosač stroja dupli 22x28 M27x3 22x28 M24x2		190259 190260 100222 191936	R-osigurač Ø 4 mm Ø 5 mm Ø 6 mm Ø 8 mm	
196607 197102	Osigurač preklopni Ø14, L=56 mm Ø16, L=65 mm		198872 198877 198875 198878 198880 198882	2R-osigurač Ø 2 mm Ø 3 mm Ø 4 mm Ø 5 mm Ø 6 mm Ø 7 mm	
100189 197678	Osigurač preklopni Ø8, L=45 mm Ø10, L=80 mm		198589 193065 193066	Poluga vezna LxBx Ø 660x63x22 810x63x25 920x75x33	

20



SUSTAV KOPČANJA I VUČE

ZATVARAČI STRANICA PRIKOLICA

ŠIFRA	NAZIV	ŠIFRA	NAZIV
196745D 196745L	Zatvarač stranice Desni Lijevi	197218D 197218L	Zatvarač stranice Desni Lijevi
196755	Kuka zatvarača	199394	Zatvarač stranice
198296D 198296L	Zatvarač stranice Desni Lijevi	196455	Kuka zatvarača
197509	Zatvarač stranice	190846	Zatvarač stranice
197511	Zatvarač stranice	193399	Kuka zatvarača
197510	Kuka zatvarača	194196	Zatvarač stranice
196935	Zatvarač stranice s osiguračem	194193	Kuka zatvarača
198427D 198427L	Kuka zatvarača Desna Lijeva	199446	Nosač bolcne zatvarača

20



SUSTAV KOPČANJA I VUČE

ZATVARAČI STRANICA, PARKIRNE NOGE, VIJCI KOTAČA VUČE, OSOVINE PRIKOLICE

ŠIFRA	NAZIV	ŠIFRA	NAZIV
199444	Klin zatvarača	199302	Vuča okretna 4t s atestom
199447	Pant stranice	199303	Vuča okretna 7t s atestom
192160 194175	Parkirna noga HxH2xB 470x608x160 570x710x160	199300	Vuča okretna 10t s atestom
198712	Parking noga 600 kg nosivosti	199304	Vuča 3t s atestom
196951	Parkirna noga s preklopnim kotačem 1000 kg nosivosti	199305	Vuča 5t s atestom
198787 197554 190749	Vijak kotača M14x1,5 L2=48 mm M16x1,5 L2=47 mm M20x1,5 L2=54 mm	199306	Vuča 10t s atestom
198786 198384 040112	Matica kotača M14x1,5 SW 19 M16x1,5 SW 24 M20x1,5 SW 27	197647 192965	Stol okretni prikolice Ø 850 mm Ø 950 mm
199301	Vuča okretna 2,5t s atestom	120053 198713	Glavčina za prikolicu 50x50 L=200 mm 50x60 L=200 mm



SUSTAV KOPČANJA I VUČE

OSOVINE PRIKOLICA, BLATOBRA NI

ŠIFRA	NAZIV	ŠIFRA	NAZIV
197370	Osovina prikolice 60x60 mm L=1500 mm s kočnicama	100193	Blatobran PVC RxLxA 590x950x300 mm
040488	Blatobran PVC RxLxA 480x800x230 mm		

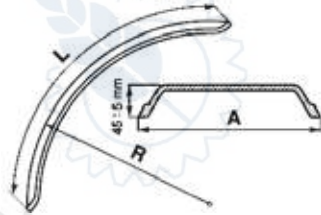

TRANSMISIJA - ZRAČNI SUSTAV

ŠIFRA	NAZIV	ŠIFRA	NAZIV
199771	Spojka zraka bez ventila M16x1,5	197326	Cilindar membranski ØA=178mm. 186 M16x1,5 M16x1,5
199722	Spojka zraka s ventilom M16x1,5	197331	Filter umetak M22x1,5
199770	Spojka zraka bez ventila M16x1,5		
199773	Spojka zraka s ventilom M16x1,5		
197317	Spremnik zraka 20L		
		198508	Crijevo za spojno
		198506	Crno Crveno
		197329	Ventil kočioni
		197325	Crijevo za zrak PVC Ø 12x1,5 Crijevo za pumpanje guma traktorsko
		198681	8 m crno
		198679	8 m crveno
		198682	12 m crno
		198680	12 m crveno

20



PODMAZIVANJE

ŠIFRA	NAZIV		ŠIFRA	NAZIV	
190863 190864	Uljenka ručna 300 g 500 g			Mazalica H1-M6x1 H1-M8x1 H1-M10x1	
197683	Mazalica 12 kg		100102 100103	Mazalica H2-M8x1 H2-M10x1	
190399	Mazalica ručna 400 g		195624 196577	Mazalica H2-M8x1 H2-M10x1	
193389 193390	Crijevo mazalice Kratko L=300 mm Dugo L=900 mm		190394 198111	Glava mazalice M10x1 R 1/8"	
199244	Glava mazalice		199324	Glava mazalice	

20

U ponudi imamo sve vrste sistema za kočenje priklučnih strojeva. Jednokružni i dvokružni!

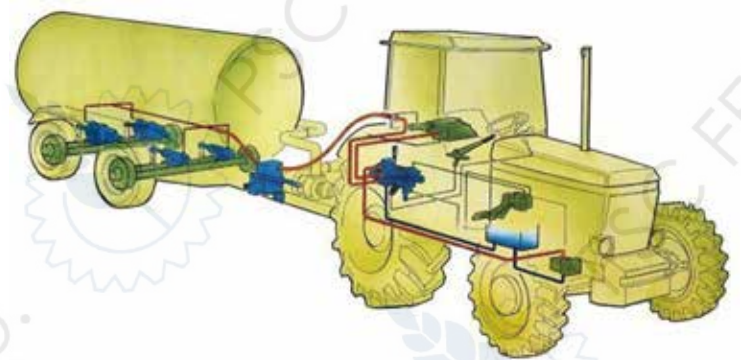



ELEMENTI HIDRAULIČKIH SPOJEVA

ŠIFRA	NAZIV	ŠIFRA	NAZIV
196566 193539 193540	Brza spojka M16x1,6 M18x1,5 M22x1,5	190370	Ventil trostrani M22x1,5
193541 193542	Brza spojka M18x1,5 M22x1,5	195079	Čep brze spojke za utikač crveni
199595 195073	Brza spojka R 1/2" M18x1,5	195080	Čep brze spojke za utičnicu crveni
195075 195076	Brza spojka M18x1,5 M22x1,5	192297 196387 196264 196386 196260 196265	Redukcija hidraulička 16x1,5/16x1,5 16x1,5/18x1,5 18x1,5/18x1,5 16x1,5/20x1,5 18x1,5/20x1,5 16x1,5/22x1,5
197985	Ventil trostrani M22x1,5	193364 191869 192664	Spojka brza za kočnice M18 muška vanj. navoj M20 muška vanj. navoj M18 ženska unut. navoj
200346 200347	Spojka hidraulička M18x1,5 M22x1,5	200348 200349 200350 200351 200352	Spojnicica hidrauličkog crijeva DN 06 DN 08 DN 10 DN 12 DN 16
202266	Spojka hidraulička M BG1 81	202201	Spojka hidraulička M Vanjski navoj M18x1,5 Faster
202267	Spojka hidraulička 2 BG1 81	202202	Spojka hidraulička Ž Vanjski navoj M18x1,5 Faster



ELEMENTI HIDRAULIČKIH SPOJEVA - IZRADA



NOVO U PONUDI!
U POLJOPRIVREDNO-SERVISNIM
CENTRIMA U
KRIŽEVCIMA I OSIJEKU
IZRAĐUJEMO SVE VRSTE
HIDRAULIČKIH CRIJEVA
PO MJERI I UZORKU



20



ELEMENTI HIDRAULIČKIH SPOJEVA - IZRADA

TIPOVI ZAVRŠETAKA HIDRAULIČKOG CRIJEVA

AGL	DKOL	DKOL 45°	DKOL 90°	AGS
DKOS	DKOS 45°	DKOS 90°	BSPK	AGR
DKOR	DKOR 45°	DKOR 90°	DKOR 90° Kompakt	AGJ
DKJ	DKJ 45°	DKJ 90° S	DKJ 90° M	AG ORFS
DK ORFS	DK ORFS 45°	DK ORFS 90° S	DK ORFS 90° M	RAM
RAR				

20





ELEMENTI HIDRAULIČKIH SPOJEVA - IZRADA

PODACI ZA NARUDŽBU HIDRAULIČKIH CRIJEVA

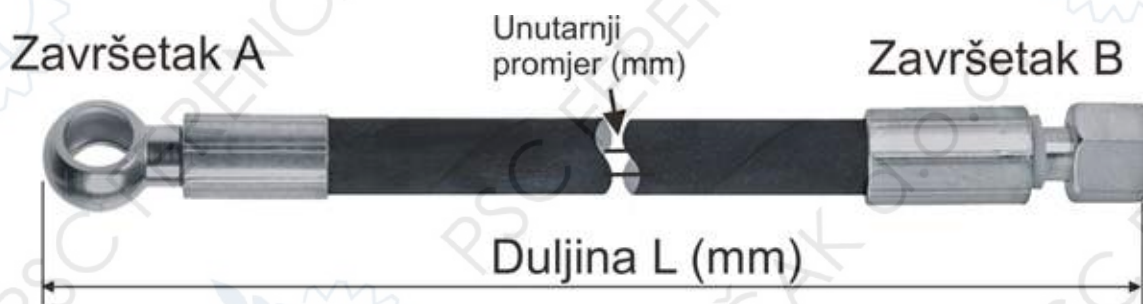

Tip crijeva

Jednoslojno*
 Dvoslojno*
 Troslojno*

* ukoliko ne možete procijeniti, donesite uzorak da procijene naši stručnjaci

Maximalni tlak _____ bar

Unutarnji promjer (mm)

8
 10
 12
 16
 20
 25
 32
 40
 _____ mm

Duljina _____ mm

Završetak A

Ravni
 45°
 90°



Promjer Ø _____ mm

Navoj
 Unutarnji
 Vanjski
 Metrički
 Colni

Promjer navoja _____ mm

Završetak B

Ravni
 45°
 90°



Promjer Ø _____ mm

Navoj
 Unutarnji
 Vanjski
 Metrički
 Colni

Promjer navoja _____ mm

Informirajte se u našim poslovnicama

Križevci	Koprivnica	Osijek	Bjelovar	Virovitica
Nikole Tesle 12	Čarda 6	Livana, Omladinska 128	Gudovečka cesta 25	Poduzetnička zona II/12
48 260 Križevci	48 000 Koprivnica	31 000 Osijek	43 000 Bjelovar	33 000 Virovitica
tel.: 048 681 902	tel.: 048 647 902	tel.: 031 211 902	tel.: 043 235 902	tel.: 033 728 902
fax.: 048 682 903	fax.: 048 647 902	fax.: 031 211 902	fax.: 043 235 902	fax.: 033 728 902

web: www.psc-ferencak.hr

e-mail: info@psc-ferencak.hr



Prostor za bilješke

A large grid area for notes, overlaid with a large, faint watermark of the PSC FERENČAK logo and the text "PSC FERENČAK d.o.o." repeated diagonally across the page.

PSC ferencak





REPROMATERIJAL



ŠPAGA	310
MREŽA ZA BALE	310
FOLIJA ZA OMATANJE BALA	311
FOLIJA SILAŽNA	311
PODFOLIJA	311
MREŽA ZA SILOS	312
MREŽA ZA VJETAR	312
VREĆA EURO-BAG	313
MREŽA TOPEX	313
BETONSKE PLOČE ZA SILOS	313
TRANSPORT BALA	314-315





ŠPAGA, MREŽA I FOLIJA ZA OMATANJE BALA



ŠIFRA	NAZIV
201829	Špaga tip 130 - Tama
197650	Špaga tip 130 - Juta
197742	Špaga tip 250 - Teufelberger
190356	Špaga tip 350 - Teufelberger
192236	Špaga tip 350 - Juta
100442	Špaga tip 400 - Teufelberger
197001	Špaga tip 400 - Juta
100490	Špaga tip 500 - Teufelberger
197229	Špaga tip 500 - Juta
100441	Špaga tip 750 - Teufelberger
197002	Špaga tip 750 - Juta
192182	Špaga tip 800 - Juta
198132	Špaga tip 1000 - Teufelberger
201383	Špaga tip 1000 - Juta

ŠIFRA	NAZIV
193518	MREŽA 123x2000m - AGRIPRES
197003	MREŽA 123x2000m - JUTA
199013	MREŽA 123x2400m - BUTTERFLY
201883	MREŽA 123x2600m - AGRIPRES
202849	MREŽA 123x2800m - AGCO
202851	MREŽA 123x2800m - DEUTZ FAHR
197004	MREŽA 123x2800m - MARATHON
202850	MREŽA 123x2800m - MC HALE
193517	MREŽA 123x3000m - AGRIPRES
197231	MREŽA 123x3000m - JUTA
195304	MREŽA 123x3600m - TAMA PRO-TEC
197005	MREŽA 123x4200m - MARATHON
202607	MREŽA 123x4500m - TAMA
198134	MREŽA 125x2000m - JUTA
196501	MREŽA 125x2600m - KRONE
200242	MREŽA 125x3000m - JUTA EXTRA
196502	MREŽA 125x3600m - KRONE
197230	MREŽA 130x2000m - JUTA
201384	MREŽA 130x3000m - JUTA



21

ŠIFRA	NAZIV
100440	TRIOPLAST TIP 500x0,25x1800m ZELENA
100481	TRIOPLAST TIP 750x0,25x1500m ZELENA
200046	TRIPLUS TIP 700x0,30x2000m
198984	F-LINE TIP 500x0,25x1800m
198985	F-LINE TIP 750x0,25x1500m
192967	SELOTEJP ZA BALE
200046	Folija za ovijanje bala 730x2000 m





SILAŽNA FOLIJA, PODFOLIJA I VREĆE ZA POKRIVANJE SILOSA



ŠIFRA	NAZIV
193202	FOLIJA SILAŽNA 4x25 m
193203	FOLIJA SILAŽNA 4x50 m
193756	FOLIJA SILAŽNA 5x25 m
193204	FOLIJA SILAŽNA 5x30 m
198392	FOLIJA SILAŽNA 5x35 m
193205	FOLIJA SILAŽNA 5x50 m
193206	FOLIJA SILAŽNA 6x25 m
197207	FOLIJA SILAŽNA 6x30 m
193757	FOLIJA SILAŽNA 6x35 m
193208	FOLIJA SILAŽNA 6x50 m
196548	FOLIJA SILAŽNA 6x 300m
193866	FOLIJA SILAŽNA 7x25 m
193209	FOLIJA SILAŽNA 7x30 m
193865	FOLIJA SILAŽNA 7x35 m
193210	FOLIJA SILAŽNA 7x50 m
196549	FOLIJA SILAŽNA 7x300 m
193864	FOLIJA SILAŽNA 8x25 m
193211	FOLIJA SILAŽNA 8x30 m
193870	FOLIJA SILAŽNA 8x35 m
193212	FOLIJA SILAŽNA 8x50 m
195450	FOLIJA SILAŽNA 8x300m
197015	FOLIJA SILAŽNA 9x25 m
196144	FOLIJA SILAŽNA 9x30 m
193521	FOLIJA SILAŽNA 9x50 m
197777	FOLIJA SILAŽNA 10x25 m
194834	FOLIJA SILAŽNA 10x30 m
193522	FOLIJA SILAŽNA 10x35 m
193213	FOLIJA SILAŽNA 10x50 m
197132	FOLIJA SILAŽNA 10x300 m
197778	FOLIJA SILAŽNA 12x25 m
193871	FOLIJA SILAŽNA 12x30 m
195446	FOLIJA SILAŽNA 12x35 m
193519	FOLIJA SILAŽNA 12x50 m
197133	FOLIJA SILAŽNA 12x300 m
193758	FOLIJA SILAŽNA 14x50 m
193289	FOLIJA SILAŽNA 16x50 m

ŠIFRA	NAZIV
193216	PODFOLIJA 4x50 m
196547	PODFOLIJA 4x100 m
193214	PODFOLIJA 5x50 m
193215	PODFOLIJA 6x50 m
193218	PODFOLIJA 7x50 m
193217	PODFOLIJA 8x50 m
197779	PODFOLIJA 8x 100 m
193872	PODFOLIJA 9x50 m
193219	PODFOLIJA 10x50 m
197780	PODFOLIJA 10x100 m
193220	PODFOLIJA 12x50 m
196166	PODFOLIJA 12x100 m
196167	PODFOLIJA 12x150 m
195448	PODFOLIJA 14x50 m
193759	PODFOLIJA 14 x100 m
195449	PODFOLIJA 16x50 m
194488	PODFOLIJA 16x100m



Vreće se ne preporuča odlagati na zemlji kako bi se sačuvala od lošeg utjecaja vlage. Preporuča se odlaganje na paletama. Vreće su otporne na UV svjetlo.

ŠIFRA	NAZIV
193797	VREĆE ZA POKRIVANJE SILOSA 120x27
194602	VREĆE ZA POKRIVANJE SILOSA 100x30



MREŽA ZA SILOS I MREŽA PROTIV VJETRA

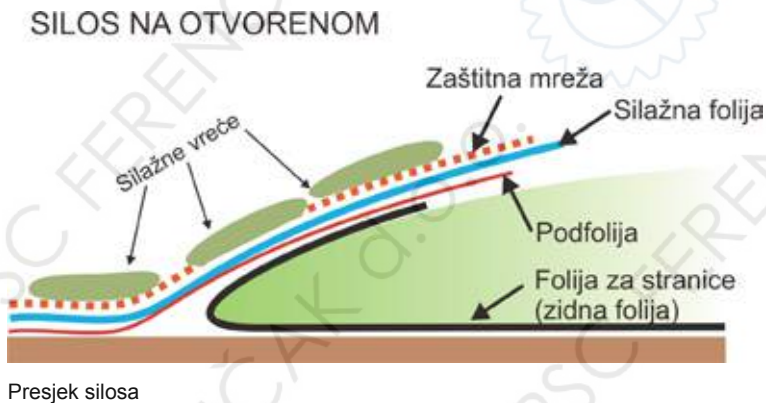
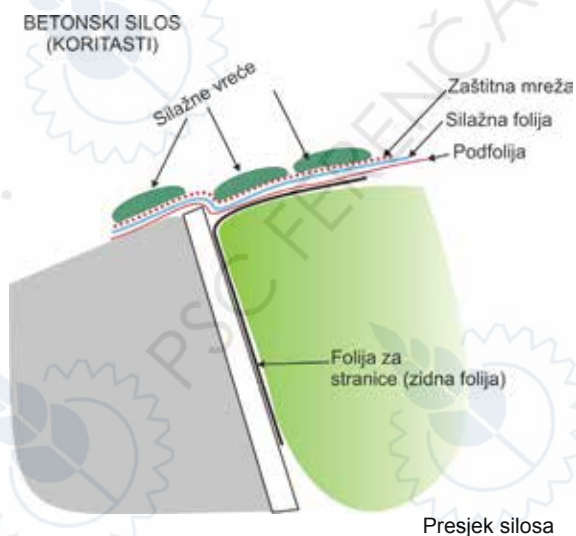

ŠIFRA	NAZIV
193223	MREŽA ZA SILOS 4x5 m
193224	MREŽA ZA SILOS 5x6 m
193225	MREŽA ZA SILOS 5x7 m
193226	MREŽA ZA SILOS 5x8 m
193227	MREŽA ZA SILOS 5x10 m
194600	MREŽA ZA SILOS 5x13 m
193228	MREŽA ZA SILOS 6x10 m
193229	MREŽA ZA SILOS 8x10 m
196731	MREŽA ZA SILOS 8x 15m
193873	MREŽA ZA SILOS 9x5 m
193230	MREŽA ZA SILOS 10x12 m
194599	MREŽA ZA SILOS 10x15 m
193516	MREŽA ZA SILOS 12x15 m



Napunjen i pokriven silos



21

ŠIFRA	NAZIV
194835	MREŽA ZA VJETAR 1 m
193760	MREŽA ZA VJETAR 1,5 m
193761	MREŽA ZA VJETAR 2 m
193762	MREŽA ZA VJETAR 2,5 m
195639	MREŽA ZA VJETAR 3 m
197545	MREŽA ZA VJETAR 4 m
197546	MREŽA ZA VJETAR 5 m



VREĆE EUROBAG, MREŽE TOPEX I BETONSKE PLOČE

VREĆE EUROBAG

ŠIFRA	NAZIV
196662	VREĆA EURO-BAG 2x60 m / 200 mikr.
196663	VREĆA EURO-BAG 2,4x60 m / 240 mikr.
196664	VREĆA EURO-BAG 2,7x60 m / 240 mikr.
196008	VREĆA EURO-BAG 3x60 m / 225 mikr.
196221	VREĆA EURO-BAG 3x60 m / 240 mikr.



MREŽA ZA POKRIVANJE BALA



Mreža omogućuje pokrivanje bala složenih u strukturu 4-3-2-1 i 3-2-1, te omogućuje kvalitetno strujanje zraka uz bale. (Na slici se vidi struktura 3-2-1.). Mrežu odlikuje visoka vlačna čvrstoća, vjetar je ne podiže, postojana na UV zračenju, omogućuje sušenje slame i nakon obilnih kiša. Nakon upotrebe potrebno je mrežu osušiti i suhu pospremiti.

Dimenzije: Š=9,8 m, D=12,5 m, širina role 2,45 m, težina role 18 kg ili
Š=9,8 m, D=25 m, širina role 2,45 m, težina role 37 kg

ŠIFRA	NAZIV
198235	MREŽA -TOPEX - ZA POKRIVANJE BALA 9,8 m širina i dužina 25 m
204682	MREŽA -TOPEX - ZA POKRIVANJE BALA 12 m širina i dužina 25 m

MREŽA ZA POKRIVANJE BALA



SILOS
vl. Čolig Ivo
Veliki Grđevac



21

ŠIFRA	NAZIV
194772	Betonska ploča za silos 2,2 x 1,33 m
195529	Betonska ploča za silos 2,2 x 1,5 m
197024	Betonska ploča za silos 2,2 x 1,75 m
197256	Kanalice za betonske silose



TRANSPORT BALA

ŠIFRA	NAZIV	ŠIFRA	NAZIV
199763	Trokut brzog kopčanja Kat. 2	199764	Trokut brzog kopčanja Kat. 3
199765	Nosač suhih bala sa špicama	199758	Trokut brzog kopčanja
	Gurtna s mehanizmom	199766	Kopčanje za hvataljke
199123	3t, 6 m		
198797	4t, 6 m		
198798	4t, 8 m		
198799	5t, 6 m		
198800	5t, 8 m		
		199767	Kopčanje za hvataljke

ŠPICE UTOVARIVAČA

- Špica utovarivača
- 199295 M22x1,5 B=800 mm
 - 199296 M22x1,5 B=900 mm
 - 199297 M22x1,5 B=1100 mm
 - 199298 M28x1,5 B=1400 mm

21

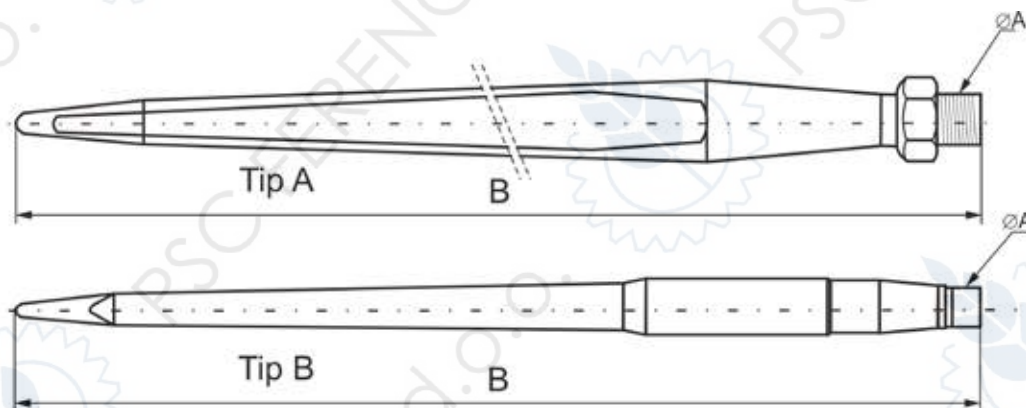



TRANSPORT BALA

PIKSE ZA ŠPICE UTOVARIVAČA

Kat. Broj	DIMENZIJE			
	A (mm)	B (mm)	C (mm)	D (mm)
	34,5	110	24,5	50
	42	110	32	50
	44	120	32	57

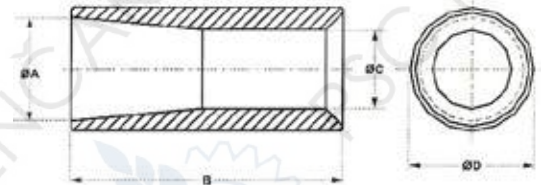

Kat. Broj	DIMENZIJE				
	A (mm)	B (mm)	C (mm)	D (mm)	E (mm)
	43,5	165	34	55	50

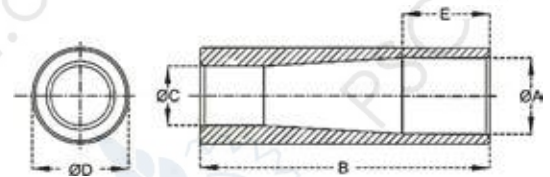

Kat. Broj	DIMENZIJE				
	A (mm)	B (mm)	C (mm)	D (mm)	E (mm)
	35	115	27	42,4	20

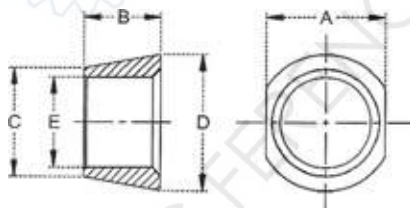
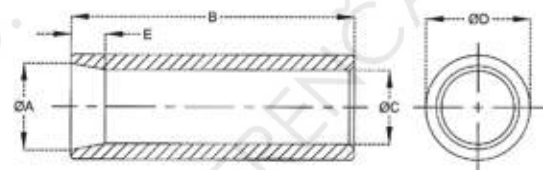

Kat. Broj	DIMENZIJE				
	A (mm)	B (mm)	C (mm)	D (mm)	E (mm)
	29,5	19	27	43	22,5

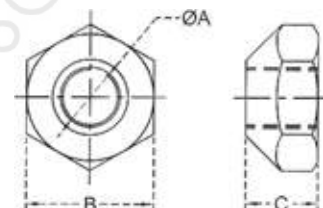
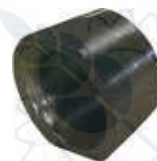

Kat. Broj	DIMENZIJE		
	A (mm)	B (mm)	C (mm)
	20x1,5	30	18
	20x1,5	32	18
	20x1,5	42	25





PAŠNJAK I STAJA

OPREMA ZA PAŠNJAKE

318

OPREMA ZA STAJE

319-323

CRIJEVA

324-325

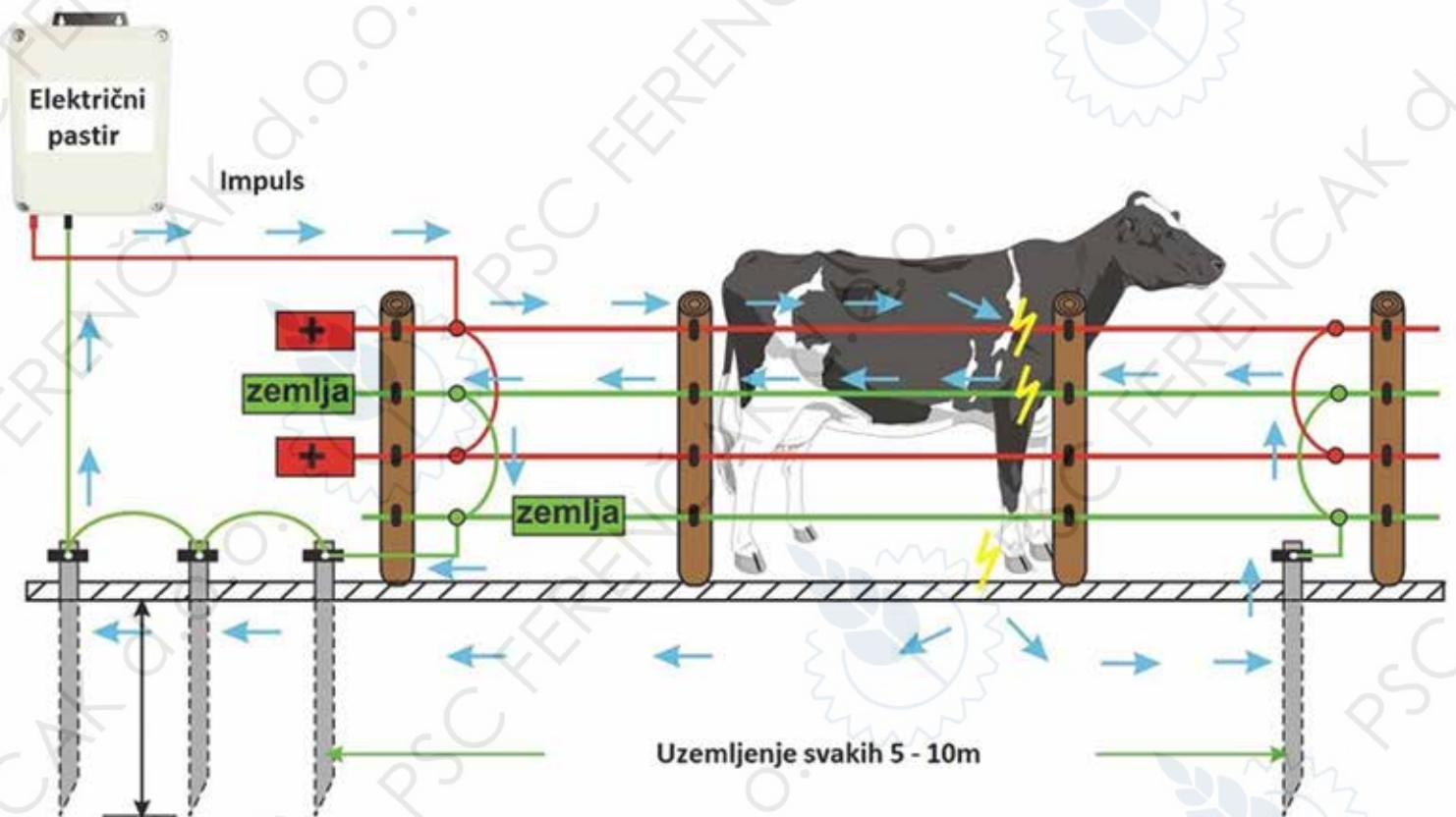

















OPREMA ZA PAŠNJAKE

ŠIFRA	NAZIV		ŠIFRA	NAZIV	
195322	Pastir električni		192554	Pastir bat. B 140 -9V	
197235	Pastir kombinirani		197381	Pastir 9-12V	
194788	Pastir komb. 220V/bat		205399		
197202	Pastir 220V/solar		200361		
205402	Pastir profi 230V		205400		
205509	Pastir 230V profi				
192555	Baterija pastira			Žica pastira	
193641	55 Ah		205455	200 m Top Line	
198322	90 Ah		192557	250 m	
	130 Ah	205417	250 m deblja		
		200220	9x400 m Top Line		
		193176	500 m		
		205433	500 m Ø6 mm		
	Žica pastira			Traka pastira	
197956	6x200 m		205454	400 m crvena-bijela	
197100	6x400 m		205450	200 m plava-bijela	
			205415	250 m Premium	
		205416	500 m premium		
		205418	500 m Ø6 mm		
	Izolator žice pastira PVC			Izolator trake pastira	
194302	23 kom		197732	navoj 4 cm	
192556	50 kom		205424	10 kom	
194703	100 kom		200251	15 kom	
199213	25 kom crni		204279	25 kom	
198354	Izolator žice pastira s maticom		30 kom		
205427	Izolator žice 20/1			Stupići PVC za pastira	
205411	Izolator žice 20/1 2 vijka		196132	105 cm	
205423	Izolator žice 30/1		198069	160 cm	
205412	Izolator žice 50/1				
205429	Izolator žice 6/1				
205405	Izolator žice 6/1 kutni				
205428	Izolator žice 75/1				
205407	Izolator žice euro 30/1				
196011	Izolator trake 10 kom		197769	Traka pastira	
200219	Izolator trake 1/2/4 cm			200 m / 400 m	
	10 kom				
205430	Izolator trake 4 cm 12/1				
205410	Izolator trake 4 cm 15/1				
201568	Izolator trake 4 cm 25/1				
205431	Izolator trake 4 cm 6/1				
205409	Izolator trake 4 cm 75/1				
22	Spojnica trake pastira			Traka pastira	
180019	20 mm širine		196064	200 m/ 10 mm	
180024	40 mm širine		194891	200 m/ 20 mm	
195955	Zatezač vrata pastira		196162	Napinjač žice	
			199254	Napinjač žice crni	



OPREMA ZA STAJE

ŠIFRA	NAZIV	ŠIFRA	NAZIV
195789	Ritulja	199883	Podizač krava
			
192545	Gonič stoke baterijski PICADOR	195420	Jež za kravu PVC
			
	Pojilica duda	040463	Pomagalo za teljenje
192346 100083	1/2" 3/4"		
			
191400	Pojilica gusena	199725	Duda za telad
			
100384 100383	Pojilica ALU L=96 mm Pojilica ALU model Šebenik L=150 mm	100082	Duda za jariče SOOTHER
196633 193185 196895	Jezik pojilice ALU Šelna pojilice ALU Šelna pojilice model Šebenik		
			
100087	Ventil pojilice za model Šebenik	193331	Grijač infra
			
100112	Ventil pojilice Muta Gorenje	193332	Žarulja za infra grijač
			
192656	Ventil pojilice		
			



OPREMA ZA STAJE - MUZILICE

ŠIFRA	NAZIV		ŠIFRA	NAZIV	
191253 195747	Sisna guma WS 1/1 4/1		100524	Sisna guma Vitrex	
195704	Sisna guma WS silikonska 4/1		199713	Čaša sisne kape inox Vitrex	
196363	Sisna guma Miele 4/1		100527	Kapa sisne čaše Vitrex	
195833	Čašica PVC WESTFALIA		190728	Stublina Vitrex	
195442	Čašica PVC ALFALAVAL		100556	Sabirnik mlijeka KPL Vitrex	
196611	Sabirnik mlijeka WESTFALIA		190765	Brtva sabirnika mlijeka	
196610	Sabirnik mlijeka ALFALAVAL		194609	Filter pulsatora 12/1	
196412	Čep sisne gume		196904	Lamela kompresora muzilice grafitna	
196647	Čep sisne gume		195820	Lamela kompresora muzilice	



















OPREMA ZA STAJE - MUZILICE

ŠIFRA	NAZIV		ŠIFRA	NAZIV	
100552 198076	Vakuum crijevo 1/1 4/1		190727	Poklopac stubline Vitrex	
199724	Crijevo vakuuma duplo WS		100522	Poklopac kante Vitrex	
194318	Crijevo mliječno L=140 mm L=180 mm		100579	Manžeta klipa Vitrex	
010287	Crijevo mliječno WS 4/1		193934	Manžeta klipa dupla novi tip Vitrex	
192145	Crijevo mliječno Ø13 mm, L=1m WS		100525	Kotač PVC Ø 200 mm Vitrex	
193395 193606	Crijevo mliječno Ø 12,7 mm Ø 16 mm		100588	Regulator vakuuma Vitrex	
192829 192827	Crijevo gumeno za vakuum Ø 8 mm Ø 13 mm (prehrambeno)		100530 195011	Prašak za pranje muzilice 1 kg 5 kg	
190281 194389	Klip PVC Vitrex (stari tip) Klip PVC Vitrex (novi tip)		193528 199226 090015 193529 090020	Deterđent za pranje muzilice 1/1 10/1 5/1 1/1 5/1	



OPREMA ZA STAJE - MUZILICE

ŠIFRA	NAZIV	ŠIFRA	NAZIV
192717	Ulje za muzilice 5/1 	193530	Sredstvo za dezinfekciju muzilice 1/1 
194690	Ulje za muzilice 1/1 	197697	Četka za pranje posuđa 
198408	Ulje za muzilice Westfalia 1/1 	198077	Četka 
196644	Vakuumetar 1/2" Ø100 mm 	192830	Četka sisne gume 
195056	Vakuumetar 1/4" Ø60 mm 	198540	Četka sisne gume 
193394 195045	Ventil vakuuma 3/4"-1" 1 1/4"-1 1/2" 	193393	Četka dugačka 
199362	Ventil vakuum 	100523	Kanta za mlijeko PVC 15L Vitrex 
197312	Ventil vakuum 	100553	Brtva poklopca kante Vitrex 



OPREMA ZA STAJE

ŠIFRA	NAZIV	ŠIFRA	NAZIV
192739 195154	Vile četiri roga MUTA KRESSER	192927 192743 190364 192749 192800 192801	Drška za: Grablje Lopatu kalač Sjekira L=1000 Sjekiru L=800 Sjekiru 400
196383	Vile tri roga KRESSER	190598	Rukavice mehaničarske BERNER vel. 9 vel. 10
193346	Lopata ALU	195822	Zaštitna maska plexi
192737 192734 195835	Lopata 161/90 161/100 162/95	195823	Zaštitna maska plexi-PVC mreža
195642	Lopata nasađena	120009	Zaštitna maska s PVC mrežicom
196165	Vile četiri roga nasađene	190865 190866 100463 100471 193392 100466	Flaks okrugli Ø1,65 mm/15 m Ø 2 mm/15 m Ø 2,4 mm/15 m Ø2,7 mm/15 m Ø 3,0 mm/15 m Ø 2,4 mm/86 m
100512 100477 100478	Izolir traka kom. Crna Crvena Žuto-zelena	198748	Lijevak sa sitom
196505	Klješta za papke	100584	Ploča brusna za papke
195788	Pločica brusna za papke	196506D 196506L 196506	Nož za papke D Nož za papke L Nož za papke obostrani

**CRJEVA****CRJEVO SA ŽIČANOM SPIRALOM - PLUTONE**

ŠIFRA	NAZIV	PROMJER (mm)
010438	Crijevo sa žičanom spiralom	ø 20
010439	Crijevo sa žičanom spiralom	ø 25
010440	Crijevo sa žičanom spiralom	ø 30
010430	Crijevo sa žičanom spiralom	ø 50



Fleksibilno crijevo s ugrađenom žičanom spiralom, može se koristiti na temperaturama od -10°C do +60°C. Koristi se transport tekućina pod sniženim tlakom.

PROZIRNO MREŽASTO CRJEVO ARIANA

ŠIFRA	NAZIV	PROMJER (mm)
190479	Crijevo prozirno mrežasto	ø 6x12
010232	Crijevo prozirno mrežasto	ø 8x14
010446	Crijevo prozirno mrežasto	ø 10x16
010447	Crijevo prozirno mrežasto	ø 13x19
010448	Crijevo prozirno mrežasto	ø 16x22
191124	Crijevo prozirno mrežasto	ø 19x26
010125	Crijevo prozirno mrežasto	ø 25x33
198772	Crijevo prozirno mrežasto	ø 30x38



Fleksibilno crijevo s ugrađenom mrežastom armaturom, može se koristiti na temperaturama od -10°C do +60°C. Koristi se transport tekućina ili kemikalija.

KRISTALNO CRJEVO - CRISTALLO

ŠIFRA	NAZIV	PROMJER (mm)
202520	Crijevo Cristalo	ø 4x6
192176	Crijevo Cristalo	ø 8x12
190651	Crijevo Cristalo	ø 10x13
192177	Crijevo Cristalo	ø 12x16



Fleksibilno prozirno crijevo, pogodno za pretakanje kemikalija, može se sterilizirati, upotreba na temperaturama od -20°C do +80°C (max. 135°C).

PROZIRNO MREŽASTO VISOKOTLAČNO ARIANA

ŠIFRA	NAZIV	PROMJER (mm)
010441	Crijevo gumeno 20 bar	ø 8x13
010442	Crijevo gumeno 20 bar	ø 10x16
010195	Crijevo gumeno 20 bar	ø 13x19
191125	Crijevo gumeno 20 bar	ø 16x23
191126	Crijevo gumeno 20 bar	ø 19x26,5
195943	Crijevo gumeno 20 bar	ø 25x33,5
194120	Crijevo gumeno 40 bar	ø 10
194121	Crijevo gumeno 40 bar	ø 13
194122	Crijevo gumeno 40 bar	ø 19
010443	Crijevo gumeno 80 bar	ø 13x22



Visokotlačna fleksibilna crijeva, dodatna mrežasta armatura i vanjski plašt otporan na atmosferilije. Otporno na sredstva za prskanje u poljoprivredi.



CRIJEVA

GUMENO CRIJEVO ZA GORIVO I ULJE MERCURIO

ŠIFRA	NAZIV	PROMJER (mm)
198756	Crijevo za gorivo crno	ø 10x17
198757	Crijevo za gorivo crno	ø 13x20
198758	Crijevo za gorivo crno	ø 19x27
198755	Crijevo za gorivo crno	ø 25x35
198778	Crijevo za ulje crveno	ø 10
198779	Crijevo za ulje crveno	ø 25



Fleksibilno crijevo s mrežastom armaturom, otporno na djelovanje otapala. Pogodno za protok goriva.

GIBLJIVO CRIJEVO ZA SJAČICE ZEUS

ŠIFRA	NAZIV	PROMJER (mm)
190309	Crijevo gibljivo	ø 32
192817	Crijevo gibljivo	ø 40
100186	Crijevo gibljivo	ø 45
191886	Crijevo gibljivo EOLO	ø 32
191887	Crijevo gibljivo EOLO	ø 35
197632	Crijevo gibljivo EOLO	ø 40
197633	Crijevo gibljivo EOLO	ø 45

Fleksibilno crijevo s ugrađenom PVC spiralom, može se koristiti na temperaturama od -40°C do +80°C.

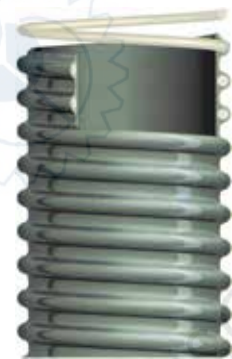

CRIJEVO ZA ZRAK SA PVC SPIRALOM SATURNO

ŠIFRA	NAZIV	PROMJER (mm)
198773	Crijevo za zrak prozirno	ø 32
198774	Crijevo za zrak prozirno	ø 35
198775	Crijevo za zrak prozirno	ø 40
198776	Crijevo za zrak prozirno	ø 45
198777	Crijevo za zrak prozirno	ø 80

Fleksibilno usisno crijevo s ugrađenom žičanom spiralom. Namijenjeno strujanju zraka pod sniženim tlakom.



CRIJEVO ZA GORIVO - ŽIČANA ARMATURA

ŠIFRA	NAZIV	PROMJER (mm)
203642	Crijevo za gorivo	ø 4,5
201103	Crijevo za gorivo	ø 6
201104	Crijevo za gorivo	ø 8
201105	Crijevo za gorivo	ø 10
201106	Crijevo za gorivo	ø 12

Fleksibilno usisno crijevo za gorivo sa žičanom armaturom izvana.







IGRAČKE



BRUDER PVC 1:16 (veće)

328-330

SIKU METALNE 1:32 (manje)

331

ROLLY TOYS (nosive za vožnju)

332





IGRAČKE M1:16 BRUDER

ŠIFRA	NAZIV	ŠIFRA	NAZIV
197493	Claas ATLES 936 RZ 1:16	199577	John Deere 7930 1:16
			
199718	Claas XERION 5000 1:16	197495	Massey Ferguson 7480 1:16
			
197499	Deutz AG 200 1:16	198397	Massey Ferguson 7480 s utovarivačem 1:16
			
191458	Deutz AGROTON X720 s utovarivačem 1:16	197500	New Holland TG285 1:16
			
199427	Fendt FAVORIT 926 Vario 1:16	197492	Renault ATLES 936 RZ 1:16
			
198528	Fendt FAVORIT 926 Vario s utovarivačem 1:16	198529	Steyer CVT 170 s utovarivačem 1:16
			
197494	John Deere 6920 1:16	197497	JCB 4CX 1:16
			
194148	John Deere 7930 s utovarivačem 1:16	199722	Prednji utovarivač 1:16
			

IGRAČKE M1:16 BRUDER

ŠIFRA	NAZIV	ŠIFRA	NAZIV
198573	Plug Lemken 1:16	199424	Prikolica tandem 1:16
			
198395	Kultivator Lemken 1:16	197700	Prikolica kiper 1:16
			
198536	Roto drljače 1:16	198533	Samoutovarna prikolica Pöetinger 1:16
			
199723	Freza 1:16	198394	Prikolica rasipač gnojiva 1:16
			
198532	Sijačica Amazone 1:16	199425	Mikser prikolica Strautmann 1:16
			
197688	Sijačica i brane Lemken 1:16	199719	Prikolica trostrani kiper 1:16
			
194149	Prikolica dvoosovinska 1:16	197698	Prikolica samoutovarna Krone 1:16
			
197695	Prikolica tandem 1:16	199720	Prikolica Amazone 1:16
			



IGRAČKE M1:16 BRUDER

ŠIFRA	NAZIV	ŠIFRA	NAZIV
198534	Prskalica 1:16	197704	Omotač bala 1:16
			
19575	Bočna roto kosa 1:16	198602	Cisterna s deponatorom 1:16
			
199576	Prednja roto kosa Claas 1:16	199423	Transporter 1:16
			
199426	Okretač sijena 1:16	197600	Kombajn Claas Lexion 480 1:16
			
197699	Prigrnjač Krone 1:16	198527	Kombajn John Deere T670i 1:16
			
199619	Kombajn za krumpir Grimme 1:16	198396	Silo kombajn Claas Jaguar 1:16
			
198535	Roto balirka Claas 1:16	197496	Kamion MB Actros 1:16
			
197691	Balirka Krone Big Pack 1:16		
			















IGRAČKE M1:32 SIKU METALNE

ŠIFRA	NAZIV	ŠIFRA	NAZIV
198605	Claas ARES 697 ATZ 1:32 metalni	197701	Prikolica 1:32 metalna
			
198604	Fendt VARIO 936 1:32 metalni	198530	Prikolica KRAMPE 1:32 metalna
			
197498	John Deere 5820 1:32 metalni	197696	Prikolica BRANTNER 1:32 metalna
			
198603	John Deere 6920 1:32 metalni	197690	Cisterna Joskin 1:32 metalna
			
198601	Massey Ferguson 8690 1:32 metalni	197693	Balirka Krone COMPRIMA V150 XC 1:32 metalna
			
199721	John Deere s prikolicom 1:32 metalni	197702	Rasipač Rauch 1:32 metalni
			
198638	JCB 8250 1:32 metalni	197703	Horsch PRONTO 4 DC 1:32 metalni
			
197694	Prikolica Joskin tandem 1:32 metalna	197689	Krone EASY CUT 1:32 metalni
			



IGRAČKE ROLLY TOYS NOSIVE

ŠIFRA	NAZIV	ŠIFRA	NAZIV
199323	Traktor John Deere 610R 		Traktor JCB 8250 s utovarivačem 00980878 
199616	Deutz-Fahr 00980661 	202258	Traktor Deutz-Fahr Agrottron X720 s utovarivačem i zračnim gumama 00980666 
199618	Deutz-Fahr prikolica kiper 	202861	Kotač traktora 390-150-12 mm 00980369 
202661	Cisterna Rolly Toys 00980671 	200915	Traktor MF8650 00980226 
199574	Traktor Steyr CVT 6225 s utovarivačem 00980219 	199617	Traktor Deutz-Fahr Agrottron X720 s utovarivačem 00980634 
202302	Metalne tačke dječje Rolly Toys 	202587	Plug prekretač Rolly Toys 

23

Potražite najnoviji asortiman igračka u našim trgovinama na internetskoj stranici

www.psc-ferencak.hr

Sve proizvode možete naručiti i kupiti pomoću naše WEB-prodaje na istoj adresi.
Narudžbe i upite možete poslati elektroničkom porukom na adresu

info@psc-ferencak.hr

Prostor za bilješke



PSC Ferencak

NARUDŽBENICA BROJ: _____

Podaci o tvrtki / OPG-u

R-1

(zaokružite ako je potreban R-1)

Naziv tvrtke: _____

Grad: _____

Ulica: _____

OIB*: _____

Podaci o kontakt osobi (naručitelju)

Ime i prezime: _____

Tel./fax.: _____

E-mail: _____

VRSTA / TIP STROJA / GOD. PROIZVODNJE _____



PSC FERENČAK

PRODAJNO SERVISNI CENTAR
NIKOLE TESLE 12, **48260 KRIŽEVCI**

TEL. +385 (48) 681 902 - PRODAJA

FAX. +385 (48) 682 903

ŽIRO RAČUN: 2402006-1100074793 ESB

POREZNI BROJ: 3660460

OIB: 92177469549

info@psc-ferencak.hr

www.psc-ferencak.hr

R.Br.	ŠIFRA PSC	ARTIKL	KAT. BROJ	KOLIČINA
1.				
2.				
3.				
4.				
5.				
6.				
7.				
8.				
9.				
10.				

NAČIN ISPORUKE: a) OSOBNO b) POŠTOM c) KURIRSKA SLUŽBA d) FRANKO KUPAC

e) DATUM / VRIJEME / MJESTO _____ / _____ / _____

NAČIN PLAĆANJA (zaokružite): obročno po predračunu gotovina

KONTAKT OSOBA PSC FERENČAK: _____

* ovi podaci su potrebni kako bi smo Vam mogli izdati R-1 račun



Prostor za bilješke



PSC Ferencak



Prostor za bilješke

PSC ferencak



Prostor za bilješke

PSC Ferencak

Mi smo uvijek s Vama, ...



PSC Ferencak

Prodaja pogonskih
strojeva



Dijelovi za pogonske
strojeve



Priključni, transportni
i radni strojevi



Dijelovi za priključne,
transportne i radne strojeve



Oprema za poljoprivredno
gospodarstvo



Igračke za djecu



Servis



Servis kardana



Servis pumpi



Izrada hidrauličkih
crijeva po mjeri



KRIŽEVCI
Nikole Tesle 12

tel. 048 681 902
fax. 048 682 903

BJELOVAR
Gudovečka c. 25

tel. 043 235 902
fax. 043 235 902

KOPRIVNICA
Čarda 6

tel. 048 647 902
fax. 048 647 902

OSIJEK
Omladinska 128

tel. 031 211 902
fax. 031 211 902

VIROVITICA
Poduzetnička zona 12/II

tel. 033 728 902
fax. 033 728 902

POSJETITE NAŠE PRODAJNE CENTRE



PSC Ferencak

KOPRIVNICA

tel./fax. 048 647 902

VIROVITICA

tel./fax. 033 728 902

KRIŽEVCI

tel. 048 681 902

fax. 048 682 903

BJELOVAR

tel./fax. 043 235 902

OSIJEK

tel./fax. 031 211 902

**POTRAŽITE PROIZVODE,
INFORMIRAJTE SE ILI
NARUČITE PUTEM WEB-a**

www.psc-ferencak.hr

ILI E-MAILOM

info@psc-ferencak.hr

**ROBU ŠALJEMO BRZO,
KVALITETNO I POUZDANO!**

ZA VAS SPAJAMO VRHUNSKJE TEHNOLOGIJE

KUPUJTE KVALITETNO I PROVJERENO!

QR - kod PSC Ferencak



© PSC Ferencak, Križevci, Nikole Tesle 12
tel. +385 48 681 902, fax. +385 48 682 903
www.psc-ferencak.hr
e-mail: info@psc-ferencak.hr

Design i prijelom: Slavko Marenčić, veljača 2016.