

HP  
140-255

# MF7600

Power, performance and efficiency - Award winning machinery from Massey Ferguson



**VISION INNOVATION LEADERSHIP QUALITY RELIABILITY SUPPORT PRIDE COMMITMENT**



**MASSEY FERGUSON**



## Award-winning for a reason

The MF 7600 Series tractor range triumphed with the Machine of the Year Award 2012 in the 180-260hp category, a Golden Tractor for the Design Award and was a finalist in the Tractor of the Year, all at the Agritechnica show in Germany.

**Why?** Because we only manufacture tractors that will ensure years of reliability, excellent cost of ownership and profitable growth for your business. Every feature has been designed to maximise productivity and efficiency whilst allowing you even greater choice when it comes to specification. Realise the powerful potential of this range of tractors and you'll soon see why we continue to win awards.

"Golden Tractor for the design 2012" - Agritechnica - Hannover - Germany

"Tractor of the Year 2012 finalist" - Agritechnica - Hannover - Germany

"Machine of the Year 2012" - Agritechnica - Hannover - Germany

"Grand Innovation Award 2012" - Agromash - Budapest - Hungary

"FIMA Innovation Award - Silver Medal" - FIMA - Zaragoza - Spain

"Polagri Gold Medal 2012" - Polagri - Poznan - Poland

"Innovation of the year 2012" - Kaunas - Lithuania



MACHINE OF THE YEAR  
2012



FIMA'2012  
Novedad Técnica





# Your tractor. Your specification. Your choice.

The concept is simple. We build powerful, highly versatile machinery to your exact specifications.



Model	MF 7614	MF 7615		MF 7616		MF 7618		
Transmission type	Dyna-4	Dyna-4	Dyna-6	Dyna-VT	Dyna-6	Dyna-VT	Dyna-6	Dyna-VT
Engine type	Generation 2 - AGCO SISU POWER e <sup>3</sup> engine with Selective Catalytic Reduction							
Capacity/ no. of cylinders	6.6/6	6.6/6	6.6/6	6.6/6	6.6/6	6.6/6	6.6/6	6.6/6
Max. horsepower ISO hp <sup>1</sup> (kW)	140 (103)	150 (110)	150 (110)	150 (110)	160 (118)	160 (118)	175 (129)	175 (129)
Max. power with Engine Power Management (ISO hp <sup>1</sup> )	155	165	175	-	185	-	200	-

<sup>1</sup> ISO TR14396

Model	MF 7619		MF 7620		MF 7622		MF 7624		MF 7626
Transmission type	Dyna-6	Dyna-VT	Dyna-6	Dyna-VT	Dyna-6	Dyna-VT	Dyna-6	Dyna-VT	Dyna-6
Engine type	Generation 2 - AGCO SISU POWER e <sup>3</sup> engine with Selective Catalytic Reduction								
Capacity/ no. of cylinders	6.6/6	6.6/6	6.6/6	6.6/6	7.4/6	6.6/6	7.4/6	7.4/6	7.4/6
Max. horsepower ISO hp <sup>1</sup> (kW)	185 (136)	185 (136)	200 (147)	200 (147)	215 (158)	215 (158)	235 (173)	235 (173)	255 (188)
Max. power with Engine Power Management (ISO hp <sup>1</sup> )	210	-	220	-	240	-	260	-	280



# Discover the new MF 7600 Series

The new MF 7600 Series is built around our trademark standards of award-winning, innovative and advanced engineering. But that's only the beginning...



The new and unique side exhaust with integrated catalysts and slip cats provide even lower emissions. The exhaust has been specially designed and placed so it doesn't impede the operator's view

New Diesel Oxidation Catalyser (DOC) - maintenance-free, clean emissions system which improves the overall efficiency of the SCR system and reduces fuel and AdBlue consumption

The very latest 2nd generation stage 3b AGCO SISU POWER e<sup>3</sup> engines with Selective Catalytic Reduction provides maximum performance without compromise

Unique Massey Ferguson styling offers a clean, ultra-modern look with excellent visibility

The new cooling package has been designed to ensure ultimate engine efficiency and easy access

Optional Integrated Front Linkage System and optional front PTO for maximum productivity in the field

Optional Quadlink Front Axle for increased ride comfort, control, output and performance

AGCOMMAND ready/  
AutoGuide ready\*

'Panorama' cab with side opening windows boasts a brand new interior with extensive updates. It offers exceptional ergonomic surroundings as well as plenty of space and comfort.

- New, optional Visio roof is available for greater upward visibility
- Operator seat turns up to an extra 20° for optimum operator comfort and greater visibility
- New curved windscreen for greater visibility
- New - choice of joysticks and armrests
- New controls in right-hand pillar
- New - instrument panel and console
- Datatronic 4 CCD

Available with either mechanical suspension\* or 'OptiRide Plus\*\*' semi-active cab suspension for greater flexibility and comfort

Choose between high-performance Dyna-4, Dyna-6 and Dyna-VT transmissions. Dyna-4 and Dyna-6 now come with Engine Power Management for extra power delivery in more demanding applications

Larger fuel and AdBlue® tanks enable extra long working days

\*Dependent on version. See specifications for more details



# The definition of excellent design

Understated and yet probably the single most important part of any Massey Ferguson tractor is its driveline. Every component of the chassis boasts immense strength, a major factor in the tractor's overall performance. This longstanding design provides versatility, power, durability and outstanding capability.

- The Massey Ferguson driveline: strong, reliable and dependable, the driveline ensures low power absorption giving great efficiency and excellent fuel savings
- The Dyna-4 and Dyna-6 transmission concept originates from The 'Dynashift' transmission launched in 1991. It continues to be constantly refined year after year
- Dyna-VT Continuously Variable Transmission continues to be one of the most popular transmissions offering maximum productivity, efficiency and operator comfort
- 20,000 transmission/rear axle units are built every year, that's millions of hours worked
- Integrated front linkage system (IFLS) available with high lift capacity of up to 4,000 kg, with optional PTO available, allowing you to attach front and rear implements to further boost productivity
- Refined power comes from the AGCO SISU Power engine with 2nd generation, e<sup>3</sup> SCR technology
- Immense rear lift capacity of up to 9,300 kg for tough, heavy-duty applications

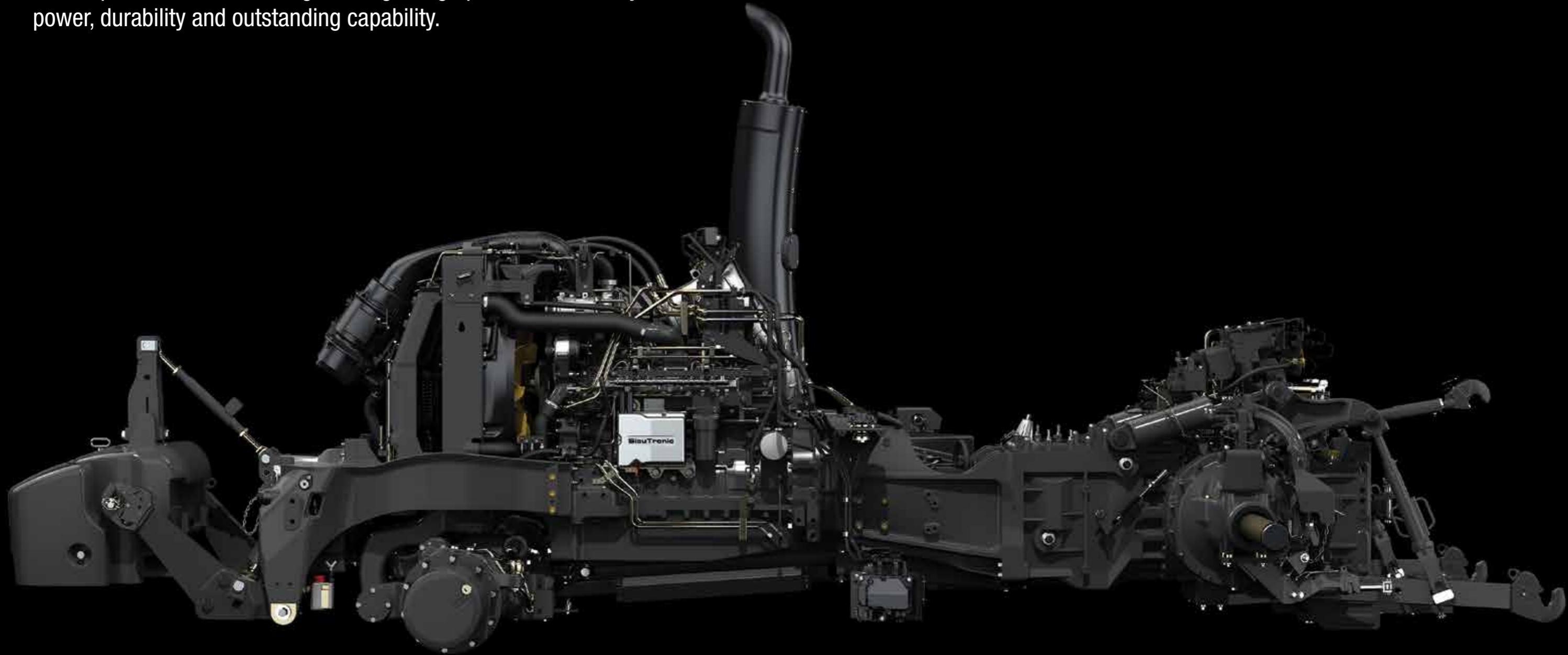

# Power, performance and economy

Cleaner, more advanced technology, outstanding fuel economy, low emissions and exceptionally high performance without compromising your business or the environment. Put less in and get more out.

The 4-valve, common rail AGCO SISU POWER, Stage 3b-compliant engine provides the ultimate in optimum power delivery, with the benefit of turbocharging and intercooling. Common rail technology ensures sufficient fuel is always available whatever the revs or load on the engine, maximising performance as the load changes.

Optimised performance across the rev range includes maximised power and minimal fuel consumption

- Low engine noise, extremely smooth and efficient
- Very low specific fuel consumption across a wide rev range
- Low engine wear
- Exceptional power and torque maximises work rate

## Intelligent engine management

All AGCO SISU POWER engines feature the latest technology. The Electronic Engine Management (EEM) enables continuous adjustment of the amount and timing of fuel injected, in relation to engine speed and load.

EEM also enables a range of advanced engine control functions, including Engine Speed Control, which is standard on 'Efficient' and 'Exclusive' model tractors.

## Engine speed control

A switch mounted conveniently in the armrest enables engine speed to be pre-set and memorised.

The ability to return quickly and easily to precise engine speed will boost productivity, improve work quality and simplify operation in almost all of your daily tasks.

## Improved fuel economy

The Electronic Engine Management system constantly monitors a wide range of parameters and makes continual and incredibly fine adjustments to fuel injection.

## Well designed cooling package

Access for daily maintenance to the radiators and filters could not be easier. The single piece bonnet lifts to provide direct access to the engine air filters, diesel cooler, air conditioning condenser, hydraulic and water radiators, as well as the intercooler. The engine oil filters and oil dipstick are easily accessible on the side of the engine. This neat and well designed cooling and filtration package provides exceptional efficiency with easy access for cleaning when required.

## Designed for pure economy

Many factors will determine real fuel consumption (l/h or l/ha) in the field and on the road, for example the efficiency of the transmission and hydraulics system.

The MF 7600 offers the operator overall efficiency from the range of transmissions to the exceptional linkage control and dynamic hydraulic systems.

Low specific fuel consumption (192 g/kWh) ensures minimal costs and low consumption across a wide rpm range.

## Power you can trust -

These new Stage 3b engines have a low engine speed rating of 2,100 rpm. This means that under full throttle the engine will rev to 2,100 rpm. Maximum power occurs at 1,950 rpm compared to a previous 2,000. High power and torque at low rpm ensures high performance, excellent fuel economy and low engine noise.

## Torque you can rely on

AGCO SISU Power engines have excellent torque characteristics to ensure that MF 7600 Series tractors keep going when conditions get more difficult. This means that the forward speed is maintained and therefore output is maximised in all conditions.

In short, our engines offer maximum torque, low fuel consumption, high power and performance with a quiet eagerness to work in the most demanding conditions.

## Outstanding fuel economy, torque and power

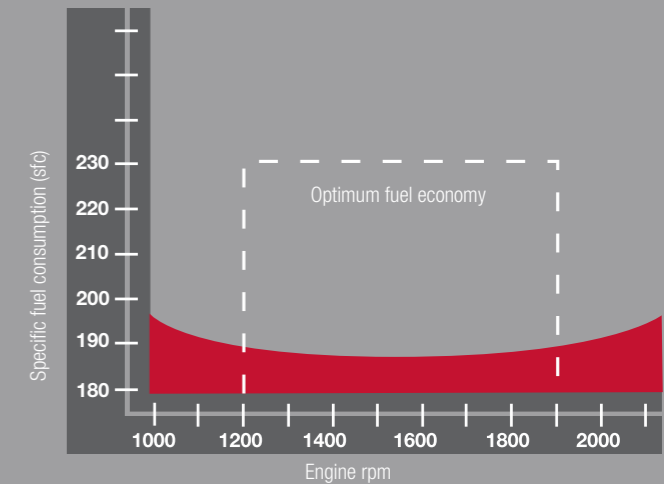

MF's electronic engine management system broadens the operating range within which the tractor is operating at optimum fuel efficiency.

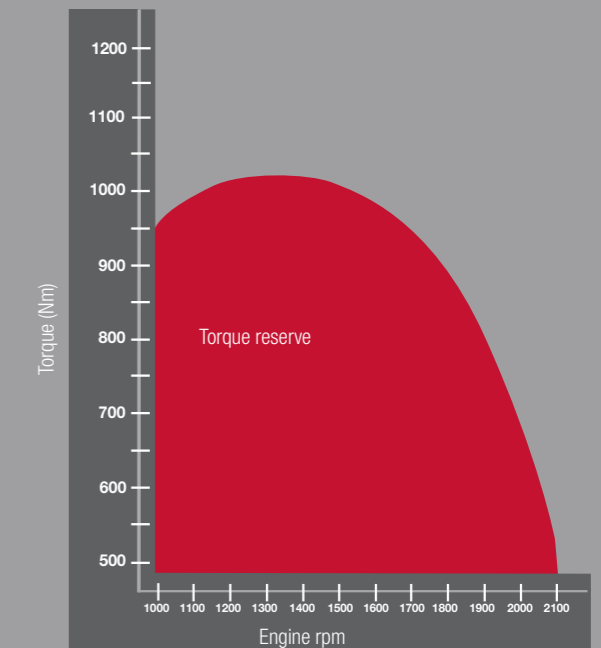

This curve clearly shows how maximum torque is maintained between 1200 and 1500 rpm, with steep torque rise as engine rpm falls between 2100 and 1500 rpm for greater torque ability and constant PTO speed.

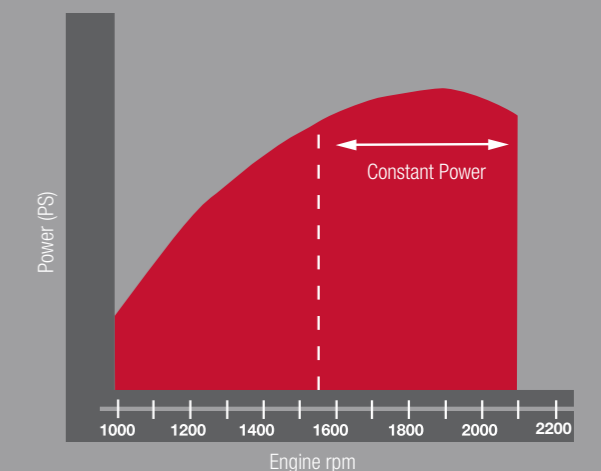

This curve clearly shows high power, with 'constant power' maintained down to 1570 rpm.





A close-up photograph of several green grass blades, likely from a wheat or similar grain, covered in numerous small, clear water droplets. The blades are arranged diagonally across the frame, and the lighting creates a soft, natural green glow. The background is a blurred, darker green, suggesting a field of similar vegetation.

## Performance without compromise

In 2008, we launched the first ever tractor range to use SCR technology, now in its second generation Massey Ferguson continues to shape the industries movement towards Selective Catalytic Reduction by including it in the new MF 7600 range. A sustainable future lies with the use of SCR and AdBlue to reduce nitrogen oxides and particulate emissions.

Having engines which comply fully to emissions regulations does not mean you have to compromise on power and productivity. AGCO SISU POWER engines have been designed to work at maximum performance in all applications, at all times.



## Economic. Efficient. Ecological - e<sup>3</sup> The facts



The AGCO SISU POWER e<sup>3</sup> SCR system is the most efficient in its class, cutting fuel costs by anything up to 16%. The AdBlue solution works in harmony with the SCR system and can be easily obtained easily from your Massey Ferguson dealer or AdBlue outlets.



AGCO SISU POWER e<sup>3</sup> engines with Selective Catalytic Reduction run at optimum efficiency without compromising engine performance. There is no need for additional service tools or expensive diagnostic interfaces in the vehicle.



By 2014, a 80% reduction in Nitrogen Oxides is required as part of Europe wide legislations on emissions levels. By using the e<sup>3</sup> SCR system since 2008, we are ready to meet these regulations. This technology offers big savings in fuel costs as well as protecting our environment and our health, well into the future.

### The system.

#### New Diesel Oxidation Catalyser (DOC)

Located beneath the bonnet, the DOC is conveniently positioned so it does not impede access or visibility for the operator. The DOC ensures the efficient running of the SCR system and ensures a reduction in AdBlue. There's no need to worry about servicing and cleaning, the system is maintenance-free thanks to the overall design.

#### Improved monitoring of Nitrogen oxides (NOx) and exhaust temperatures

Ultimate accuracy of AdBlue injection ensures that the correct amount is injected at all times.

#### New position of Urea (AdBlue) tank

Provides better insulation of AdBlue in low operating temperatures and insulates from high operating temperatures.

#### Larger fuel (up to 430l) and AdBlue (up to 40l) tanks

Work for longer without worrying about refuelling.

#### Proven savings

The operator will benefit from significant fuel savings that would not normally be available without SCR. AGCO SISU POWER continues to develop the most economical and efficient tractor engines.

#### Performance perfect

AGCO SISU POWER e<sup>3</sup> engines with SCR, run at optimum efficiency without compromising engine performance. There is no need for additional service tools or expensive diagnostic interfaces in the vehicle with the use of SCR.



# Silent partner

The SCR system works away silently in the background, the only time you'll notice it is when fuel economy starts to impress. Realise the potential of SCR with significant increases in fuel savings, excellent power and cleaner emissions leaving the machine.

## Stage 3b Selective Catalytic Reduction System - overview

Massey Ferguson were the first to use Selective Catalytic Reduction in tractors and combines. It's now a tried and trusted solution in its second generation of production.

Special feature	Outstanding benefit
Exhaust includes the catalytic converters and slip cats within the exhaust silencer	A unique and efficient solution for improved emissions
Diesel Oxidation catalyser (DOC) beneath the bonnet	The convenient position does not impede access or visibility, is maintenance free and reduces AdBlue consumption
Improved monitoring of NOX and exhaust temperatures	Better accuracy of Diesel exhaust fluid (AdBlue) injection
Improved heating uses a combination of electric and engine coolant	A simpler and more efficient heating system
New position of Urea (AdBlue) tank	Better insulation of AdBlue in extreme operating temperatures
Larger fuel and AdBlue tanks	Longer working hours before needing to refuel

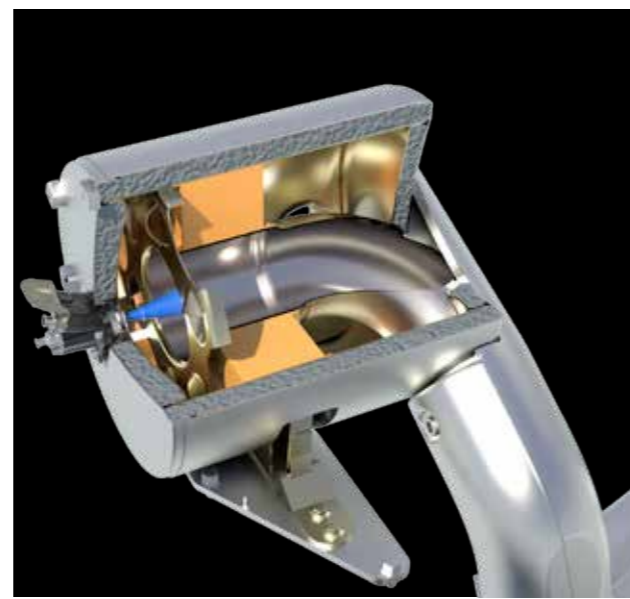

### Sleek, waisted bonnet design

It's what's inside that counts. The bonnet of the MF 7600 Series has been shaped so that it is narrow and close to the front windscreen. This improves the visibility to the front wheels, giving the operator excellent manoeuvrability and visibility. The convenient position of the diesel oxidation catalyser (DOC) does not impede access or visibility. The innovative design ensures no extra bulk on or under the bonnet.

### Diesel Oxidation Catalyst (DOC)

The second generation SCR system includes the Diesel Oxidation Catalyst. The DOC is completely maintenance-free. This sophisticated system works discreetly in the background while the machine itself works at its absolute optimum efficiency and maximum power. The Selective Catalytic Reduction does not require particulate filter regeneration like typical EGR systems.

### New exhaust system

The new exhaust system now includes catalytic converters within the exhaust silencer. These provide a unique and efficient solution for improved emissions. The oval design of the exhaust means it sits perfectly behind the pillar of the cab, allowing the operator excellent visibility.

### AdBlue™ and fuel tank

The AdBlue reservoir has been carefully positioned to ensure that the AdBlue is well insulated from cold and hot temperatures. The large capacity fuel tank holds enough fuel to get you through a long day out in the fields or in road transport without the worry of constantly refuelling.



# How Selective Catalytic Reduction works

Find out how Selective Catalytic Reduction can work for you, helping to reduce damaging emissions and high fuel costs.

## How the system works

All models in the MF 7600 Series range come with Selective Catalytic Reduction (SCR) as standard, meaning that whichever machine you choose, you'll receive the best possible engine performance and economy.

The main components of the SCR system comprise of a Diesel Oxidation Catalyser (DOC), an AdBlue injector and two catalysers and slipcats. The SCR system on AGCO SISU POWER e<sup>3</sup> engines treats the exhaust gases that would normally enter and damage the atmosphere, using AdBlue<sup>®</sup> diesel exhaust fluid.

The Diesel Oxidation Catalyser (DOC) underneath the bonnet further improves the cleaning process of gases. It has been specifically designed to prevent clogging, is highly efficient, maintenance free and fully meets EU emissions regulations. This combination of AGCO SISU POWER engine, diesel oxidation catalyser and a newly designed exhaust ensures the system more than meets legislation.

AdBlue is held in a separate tank conveniently located next to the fuel tank and is consumed at an average rate of 3-4% AdBlue to diesel, depending on application. The AdBlue tank only needs to be filled every second fuel tank fill.

A 600 litre container of AdBlue is enough to treat 15,000-20,000 litres of diesel safely whilst still maintaining optimum performance throughout.

## Optimised combustion

The characteristics of the SCR system mean that optimised combustion generates around 15% less heat. This compact cooling package allows the system to use less power to drive the fan, giving not only a reduction in heat but a lighter and more efficient cooling package that won't compromise visibility.

The life span of SCR equipment is equal to the engine's lifetime, and the system is practically service free. The operator hardly notices the presence of SCR at all. What the operator will notice however, is the significant savings in operating costs.

This is technology for tomorrow, ready for you to use today. For your future, for your business, for the environment.

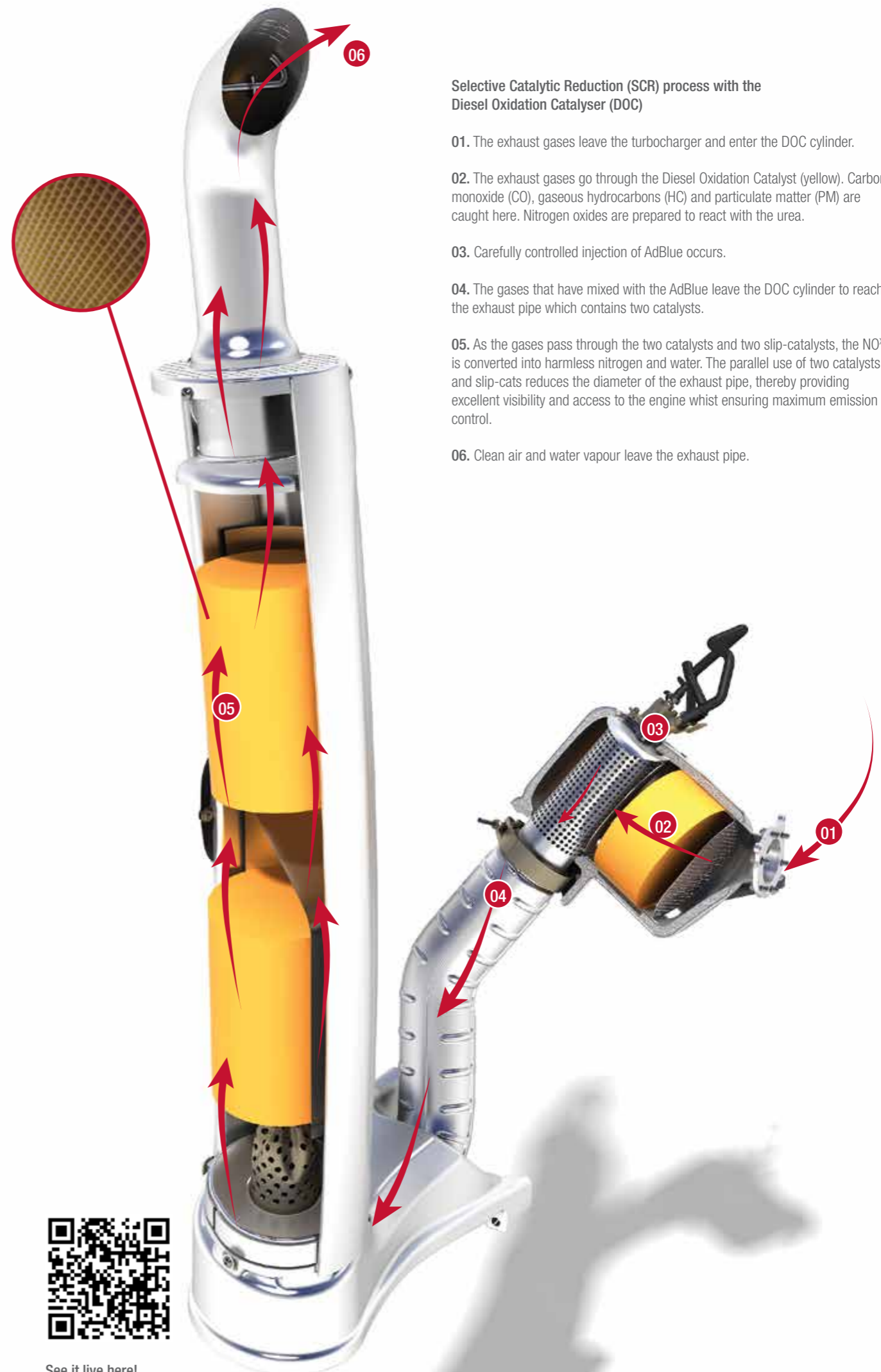

## Selective Catalytic Reduction (SCR) process with the Diesel Oxidation Catalyser (DOC)

01. The exhaust gases leave the turbocharger and enter the DOC cylinder.
02. The exhaust gases go through the Diesel Oxidation Catalyser (yellow). Carbon monoxide (CO), gaseous hydrocarbons (HC) and particulate matter (PM) are caught here. Nitrogen oxides are prepared to react with the urea.
03. Carefully controlled injection of AdBlue occurs.
04. The gases that have mixed with the AdBlue leave the DOC cylinder to reach the exhaust pipe which contains two catalysers.
05. As the gases pass through the two catalysers and two slip-catalysts, the NO<sub>x</sub> is converted into harmless nitrogen and water. The parallel use of two catalysers and slip-cats reduces the diameter of the exhaust pipe, thereby providing excellent visibility and access to the engine whist ensuring maximum emission control.
06. Clean air and water vapour leave the exhaust pipe.



See it live here!



# Three transmissions. One choice. Yours.

Massey Ferguson continues to offer some of the most refined transmissions on the market. This newest option best reflects the synergy between tractor and operator. There is a choice, it's yours.



It's a feeling you won't get from any other transmission system. Whether on the road or out in the field, straightforward and effortless handling combine to give consistently smooth changes of speed.



# Exceptional comfort and quietness, exceptional performance and exceptional choice - The **Dyna** Transmission range from Massey Ferguson

There's nothing 'standard' about the functionality you'll come to find on all of our transmissions. We have incorporated the best features into each tractor, making our transmissions the most straightforward, most efficient on the market. All models feature Massey Ferguson's left-hand multi-functional Power Control lever for easy operation and exceptional productivity.

Dyna transmissions are exceptionally easy to operate. And with a choice of either left- or right-hand control, there's real operating flexibility to suit different applications and driver preference. All Dyna transmissions consist of outstanding characteristics; some familiar ones, others which have been newly introduced to aid efficiency and productivity.



## Common transmission features that make all the difference

- Convenient left-hand Power Control lever pictured below
- Pedal-free operation, which reduces operator fatigue and makes general operation much easier
- Plenty of gears between 4 and 12 Km/h with a good overlap between gears
- For maximum versatility and increased output, AutoDrive comes as standard - Autodrive is an automated function for automatic upshifting and downshifting and is adjustable according to the engine revs
- Brake pedal pressure puts the transmission into neutral so there's no need to de-clutch during loader work, saving time and operator effort
- Reverse shuttle progressivity adjustment
- Progressivity adjustment for Dynashift ratios
- Cruise control speeds (SV1/SV2)
- Setting of upper and lower engine speeds

Cab interior type	Dyna-4		Dyna-6		Dyna-VT	
	Essential	Essential	Efficient	Exclusive	Efficient	Exclusive
MF 7614	•					
MF 7615	•	•	•	•	•	•
MF 7616		•	•	•	•	•
MF 7618		•	•	•	•	•
MF 7619		•	•	•	•	•
MF 7620		•	•	•	•	•
MF 7622		•	•	•	•	•
MF 7624		•	•	•	•	•
MF 7626		•	•	•	•	•

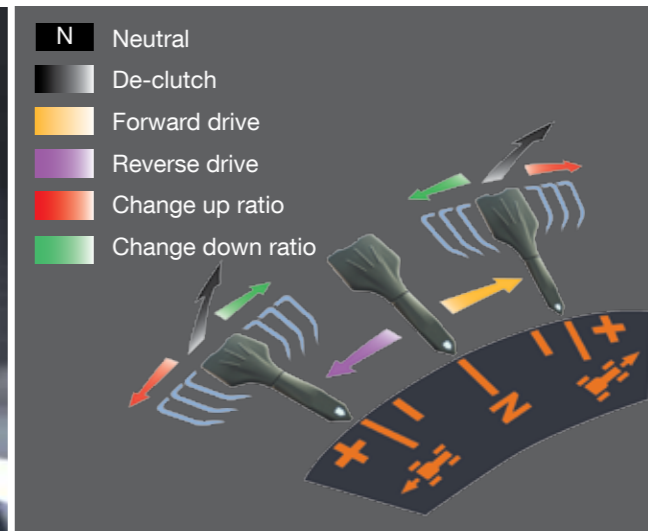

### Power Control lever

The left-hand Power Control lever provides convenient and straightforward operation. From here you can operate forward/reverse shuttle, powershift and range changes and fingertip de-clutching, leaving the right hand free to operate the loader or rear implements.



# Dyna-4 For first-rate productivity

Dynamic performance & efficient design behind the Dyna-4 transmission continues to impress with incredibly smooth 4-speed, powershift change in each of the four ranges, giving you first-rate productivity, everytime.

Dynamic performance comes from the optimised design of the Dyna-4 transmission. Well known features include Power Control, 'pedal-free' operation, 4-speed PowerShift, Speedmatching and Autodrive.

## Left-hand control

The left-hand Power Control lever provides convenient forward/reverse shuttle, powershift and range changes and fingertip de-clutching, leaving the right hand free to operate the loader or rear implements.

## Right-hand control

Simply move the T-shaped transmission control lever forwards or backwards to change up or down through the four Dynashift ratios and the four ranges.

When changing range, Speedmatching automatically selects the correct Dyna-4 ratio to match the tractor's forward speed.

## Comfort control

Smooth or fast shuttling – the choice is yours – the system is fully adjustable. You then have the perfect tractor for loader work.

## Creep and Supercreep

Close control in specialist low-speed tasks is assured with an additional 16 (supercreep) gears, enabling forward speeds as low as 160m/hr to be achieved.

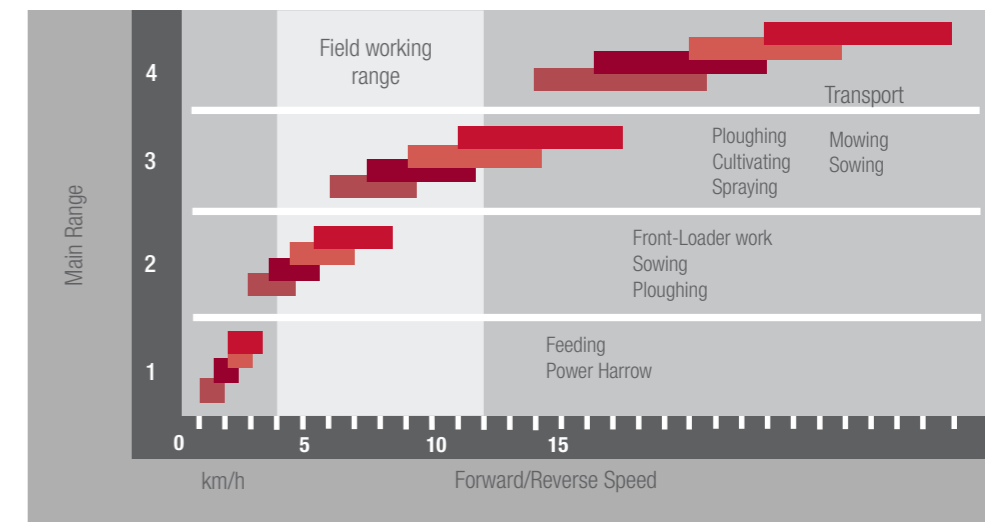

The Dyna-4 transmission offers four Dynashift changes in each range, excellent ground speed 'overlap' and 40 km/h maximum speed for efficient haulage operations.

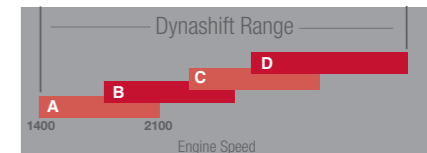

## Dyna-4 Benefits

- Optimum field performance, four range changes provide 16 forward and 16 reverse speeds, all available without having to use the clutch pedal!
- Operation is simple and less repetitive with ergonomically placed controls, reducing operator fatigue and stress
- The left-hand Power Control lever enables convenient and straightforward operation
- For rapid and precise loader work, Comfort Control maintains stability during smooth or fast shuttling
- The choice of pedal and lever mode minimises operator effort and maximises productivity
- Straightforward design and proven, reliable components provide exceptionally smooth operation with strength and longevity



# Dyna-6 Performance, refined

Dynamic performance comes as standard with Dyna-6 transmission. And now, this ultra-reliable, semi-powershift gearbox is even more refined.

The original and best semi-powershift transmission in the field today, Dyna-6 combines effortless operation with complete efficiency to create an extraordinary operator experience.

Dyna-6 continues to offer all the essential features such as left-hand Power Control, AutoDrive, right-hand control, Speedmatching and variable shuttle take-up but is now available with Power Management.

Dyna-6, uniquely, provides a smooth, 6-speed Dynashift change in each of four gears.

So you have a tremendous range of powershift flexibility over a wide speed range, giving maximum field performance. With the capability of both Dynashift and range changes being made under load, without the need to use the clutch pedal.

Dyna-6 comes with Eco as standard - reducing engine speed at max forward speeds providing a quieter drive and less fuel consumption.

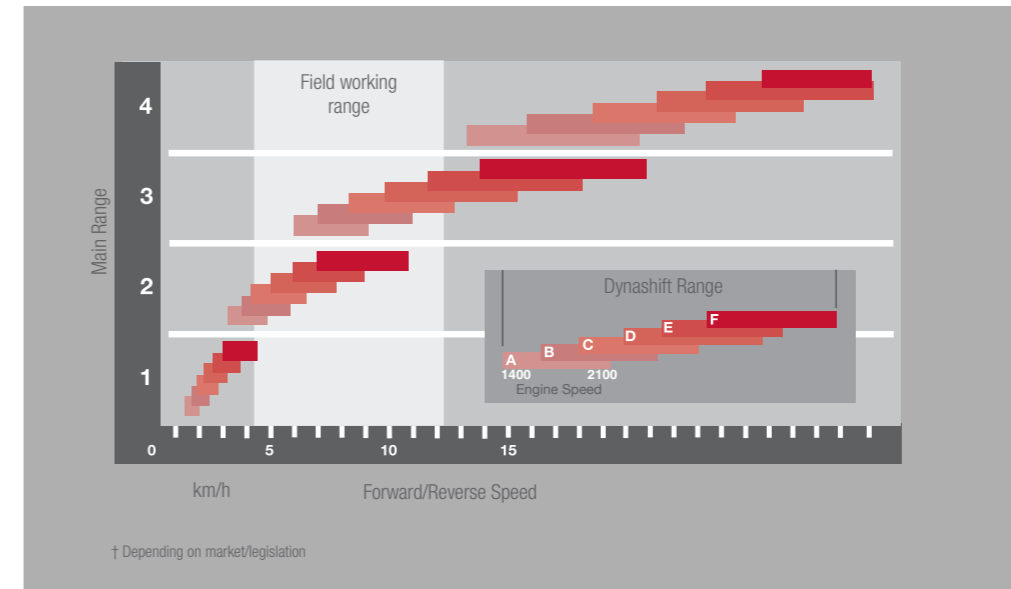

The 40 km/h Dyna-6 Eco gearbox offers six Dynashift changes in each range, excellent speed overlap and maximum speed at 1800 rpm (1900 rpm for the 50 km/h transmission)†



## Dyna-6 Benefits

- 6 Dynashift (powershift) ratios
- Maximum productivity with 24 forward gears and 24 reverse gears
- Power Control Lever with three functions on one lever - Forward/Reverse shuttle, declutch, upshift and downshift
- Pedal-free operation
- 9 speeds between 4 Km/h and 12 Km/h
- 40 Km/h or 50 Km/h maximum speed available\* at low engine speed (Eco)
- ECO feature allows top speeds to be achieved at low engine revs, offering a reduction in noise and fuel consumption
- Cruise control speeds (SV1/SV2)
- Brake pedal pressure puts the transmission to neutral
- Reverse shuttle aggressiveness adjustment, separate adjustment for forward and reverse
- Aggressiveness adjustment for Dynashift (powershift) ratios

\* Depending on market/legislation



# Dynamic Engine Power Management

Greater power when and where you need it most

The Engine Power Management allows for the continuous delivery of power under various conditions and applications, increasing productivity whilst lowering fuel consumption.

Power Management is an intelligent 'extra power' feature which works to ensure optimum efficiency for the operator. The engine responds with variable extra power delivery in demanding PTO, field and transport applications and rigorous hydraulic operations, so you automatically get power when you need it the most.

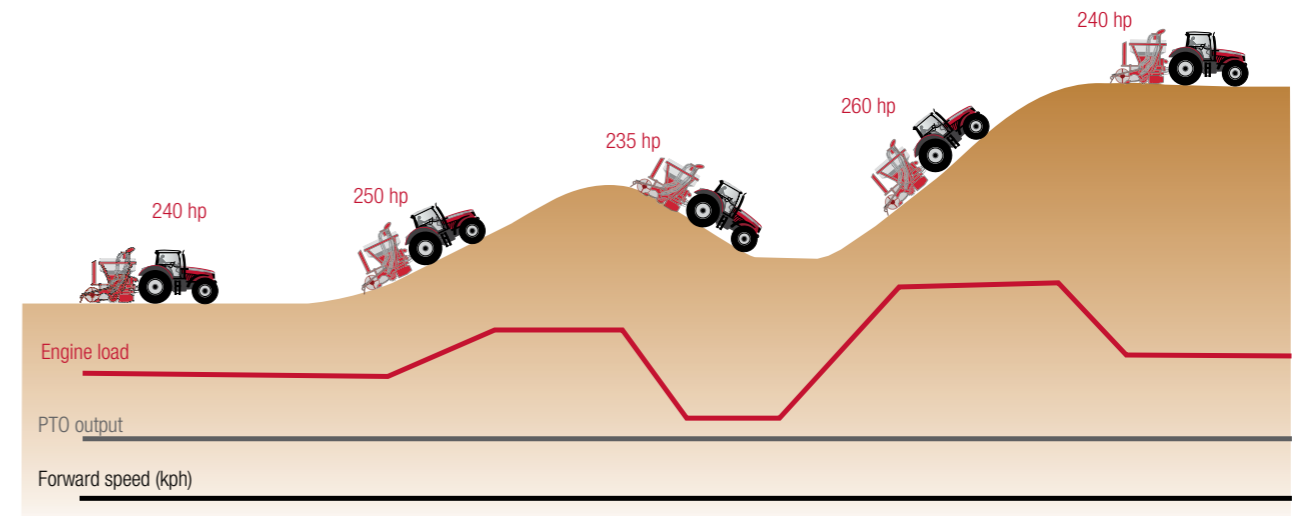

Example of MF 7624 with Dyna-6 transmission and Engine Power Management

\* Available on Dyna-4 and Dyna-6 transmissions



## Engine Power Management -The Facts

- Engine Power Management requires no operator input and becomes automatically active with PTO requirements or when groundspeed is above 6kph, delivering maximum extra power when both conditions apply
- The engine can provide up to 25 extra engine horsepower\* at 1,950 rpm. Benefit from extra power in a variety of applications from low forward speeds upwards whether in the field or on the road.
- Engine Power Management uses the electronic control of the engine and transmission to automatically maximise the amount of power available at the wheels and PTO
- This is an extremely intelligent system where the transmission electronics sense the load and operating conditions within the transmission, hydraulics and PTO
- Engine Power Management increases productivity and lowers journey times thanks to extra power

\*Depending on model



# Dyna-VT

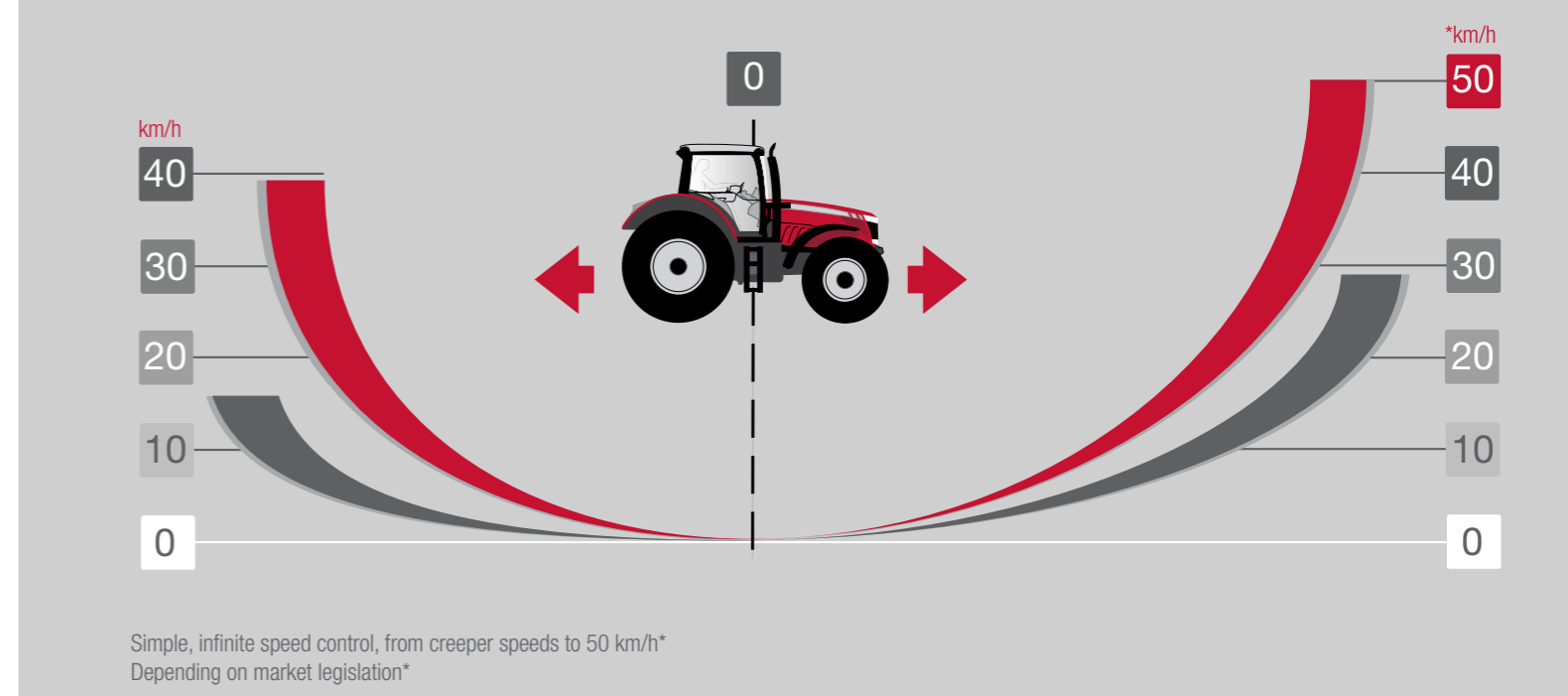

**Dynamic Tractor Management (Dyna-TM) Intelligent machine management for optimum fuel efficiency**  
Dyna-TM works in conjunction with Dyna-VT. This electronic management system automatically takes control of the engine and transmission when activated. Dyna-TM controls the engine speed according to the load on the tractor. It maintains the required forward speed whilst at the same time minimising the engine revs in order to keep fuel consumption to a minimum. Dyna-VT and Dyna-TM will work consistently at maximum efficiency and economy whilst maintaining a smoother drive quality and a noticeable reduction in fuel consumption.

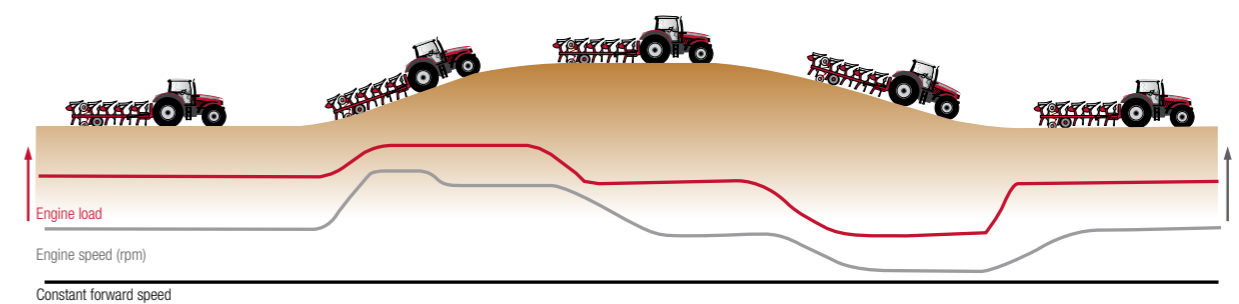

Dyna-TM: As the load (red line) varies according to the conditions, the Dyna-TM will automatically adjust the engine speed (grey line) to maintain the forward speed whilst minimising fuel consumption and noise levels.

## The ultimate transmission

Dynamic performance whatever the application. Massey Ferguson's Dyna-VT transmission provides enhanced productivity in stepless precision.

The original Dyna-VT transmission is a true testament to precision engineering; guaranteed productivity, complete operator comfort and optimum fuel efficiency at all times. Further, consistent enhancements such as Dynamic Tractor Management (Dyna-TM) make it the most intuitive transmission on the market.

### Stepless precision

Dyna-VT is amazingly simple to operate and works extremely well in differing conditions. There's no shifting of gears, no jolts and no breaks in traction or power. The unique Power Control lever makes forward/reverse shuttling and speed change convenient and hassle-free.

### The 'Supervisor'

The 'Supervisor' is on continuous stand-by and activates when engine speed falls under load. The benefit of the 'Supervisor' is that even when the load on the engine is increased and engine speed drops, the transmission will automatically reduce forward speed to maintain total power, whether in PTO applications, field work or transportation.

When used in conjunction with SV1 and SV2, which set a specified forward speed, the tractor will then operate at maximum output as load fluctuates as well as automatically adjusting the tractor back to the required speed.

## Dyna-VT Benefits

- 0,03 to 40 Km/h or 50 Km/h\*
- 40 kph super Eco or 50 kph Eco
- The choice of two speed ranges optimise torque for different applications
- Pedal, forager or lever control
- SV1/SV2 cruise speeds
- 'Supervisor' maximises the output under varying loads
- Dynamic Tractor Management (DTM) maintains the set travel speed by automatically adjusting the power (engine speed) according to load
- Active Stop
- Turbo clutch on/off
- Shuttle aggressiveness adjustment
- Pedal aggressiveness adjustment
- Switch between cruise speeds (SV1 and SV2)
- Brake pedal neutral feature

\*Depending on market legislation



## Your workspace.

## Our priority.

One of our main priorities has always been driver comfort and efficiency. Our cabs have been designed specifically to ensure the driver maintains high-levels of comfort, regardless of the application and hours spent in the seat. The MF 7600 Series offers three cab options depending on your requirements, whichever one you choose you'll benefit from important features that really make a difference to your working day.



Discover a more rapid approach to your working day. Each MF 7600 cab offers impressive features which mean you can work at a satisfying pace and finish the job sooner. Access to the cab is easy thanks to specially designed steps. Once inside the cab you will find plenty of room and a comfortable, fully adjustable operator seat with increased swivel angle. A new instrument panel displays analogue and digital information which is clearer visible to the operator at all times. Whether you choose the Essential package or the higher specification Exclusive armrest, all controls are close at hand and easy to use.



A redesigned cab shape offers superb all-round visibility. The combination of exhaust positioning, waisted bonnet design and large areas of glass ensures outstanding 360° visibility. A clear view from the rear window ensures safety and a clear view of attached implements.



MF's 'QuadLink' suspended front axle further enhances ride comfort and control. It has a compact, simple design that automatically maintains a constant suspension height, regardless of axle load.

The result is increased stability and a significant improvement in driver comfort, productivity and safety... both on the road and in the field.



Two types of cab suspension are available. A mechanical system and the electro-hydraulic OptiRide Plus system. Both offer unprecedented levels of cab comfort. The mechanical system uses silent block bushes and spring assisted shock absorbers. The design ensures controlled vertical and lateral movement and provides excellent ride quality. Mechanical cab suspension is active all the time for continuous productivity and comfort.

The OptiRide Plus cab suspension system is fully adjustable, allowing the operator to set the firmness of ride using a dial in the cab. Adjustment means the operator can control the ride quality and feel under differing terrain and speed.



# Your workspace.

Saving time, increasing productivity, making a difference.



### Datatronic Control Centre Display

The Datatronic 4-Control Centre Display (CCD) has a perfectly positioned 7" colour monitor. Mounted to the right-hand side, it is fully adjustable to meet the operator's eye level. The CCD displays important tractor information, memories and tasks and offers greater automation for headland management, trailed implement control (TIC) and dual control. The CCD has ISOBUS capabilities and can be fitted with a camera.



### More worklights

An early start or finish is no problem with eight working lights on the cab roof, two on the rear fenders, two on the hand rails and four in the front of the bonnet. Xenon lights are available as an option.

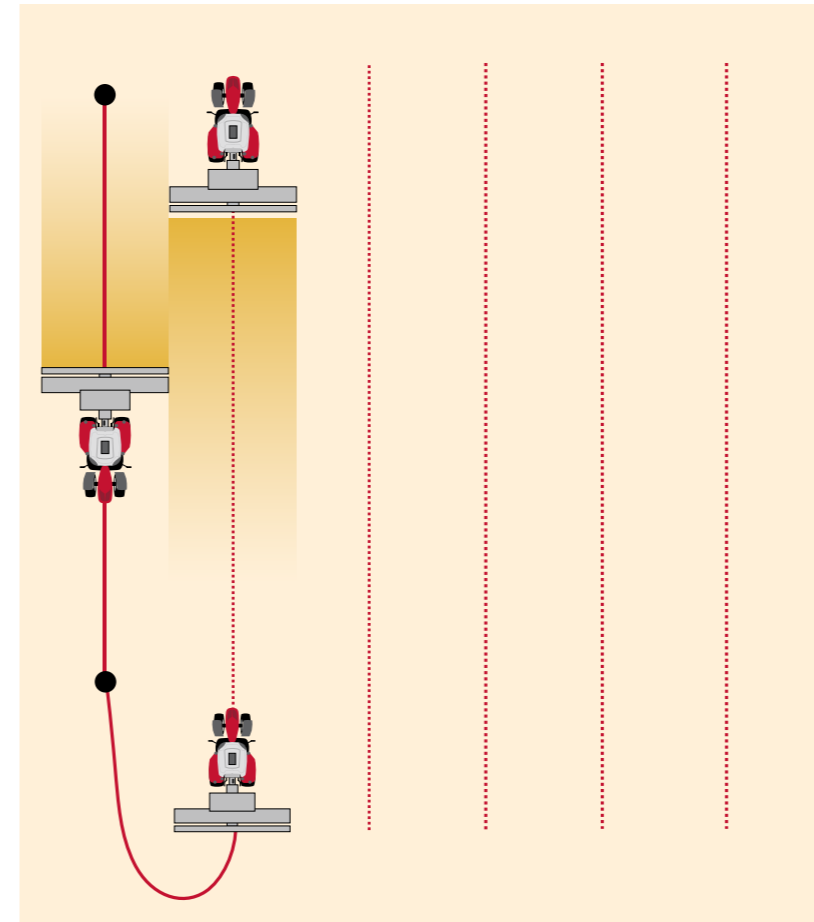

### SpeedSteer - for exact turns

SpeedSteer reduces operator effort and provides faster turns on the headland. This new, optional feature enables the operator to adjust the steering ratio and select the number of turns of the steering wheel required for a given amount of steering angle turns. The system can be switched on and off. Above 18 km/h, it automatically switches off for safe operation at high speed in the field and on the road. SpeedSteer simplifies headland turning and maximises productivity in the field.



### Cruise controls

Two cruise control speeds are available (SV1 and SV2) allowing the operator to select the required working speed and headland speed simply at the press of a button.

Cruise control is just one of the many in-cab functions that are quick and easy to use. Cruise control ensures extra comfort with no need to change groundspeed manually.

Reaching the correct and consistent speed more quickly ensures total productivity.





# Productivity at your fingertips - Three new ways to work



## Essential

This is the base specification package for the MF 7600 Series. The Essential package combines simplicity, usability and tough versatility. You can specify either Dyna-4 or Dyna-6 transmission. So, if you simply want power and performance without all the high-level extras, then this is the package for you.



## Efficient

Efficient is the medium specification package for the MF 7600 Series. Choose from either Dyna-6 or Dyna-VT transmissions, a new Command Control Armrest and both mechanical and electronic spool valves. Dedicated to delivering increased productivity thanks to key features, the Efficient specification will enable the operator to work faster, to a higher standard and with more accuracy. Expect high levels of comfort, ergonomics and reliability.



## Exclusive

The Exclusive package is a combination of high-spec versatility and refinement. With Dyna-6 or Dyna-VT transmissions, a new Command Control Armrest with Multipad lever and electronic spool valves, the Exclusive offers the best, world-renowned characteristics as well as a few new innovations. Dedicated to customers looking for a tractor with advanced features and functions, including latest ergonomics and comfort.







# Productivity at your fingertips

The 'Essential' cab package includes a long console with easily accessible controls which make operation simple and straightforward. Loader operation is controlled through the Multifunction joystick, whilst engine management, throttle, transmission and hydraulics are controlled from the long console.

Lever or pedal mode selection

Engine management: engine lower and upper limits engagement.

Transmission control lever with range change button

Multifunction loader joystick

Loader operation 3rd & 4th spool valve actuation

Forward/reverse shuttle control

Gear/range changes - increase

Gear/range changes - decrease

The neutral switch is located at the back of the joystick

Spool valve levers

Front and rear PTO switches and Auto PTO function

Work lights and beacons control panel

Electronic rear linkage adjustment

Hand throttle

Rear linkage control

Depth control

**'Multifunction' joystick main functions:**  
 A. Lift  
 B. Lower  
 C. Fill  
 D. Dump

**Combined functions:**  
 A/C. Lift and fill  
 A/D. Lift and dump  
 B/C. Lower and fill  
 B/D. Lower and dump



## The Essential specification includes:

- Dyna 4 transmission or Dyna-6 - 40 Kph Eco Autodrive transmission
- Transmission control lever in control centre
- Mechanical spool valves
- Open and closed Centre 110 l/min hydraulics available
- Standard air conditioning

## Optional

- Quadlink Suspended front axle
- Dyna-6 50 kph Eco transmission\*
- Loader ready with MultiFunction joystick
- Radar & wheel slip control
- Mechanical cab suspension
- Integrated front linkage and front PTO
- AGCOMMAND ready
- Air brakes

\*Depending on market/legislation





## Smooth, reliable, capable

The 'Efficient' cab package offers a similar pillar and new dash control centre but has a Command Control Armrest and 'T' bar lever, with a choice of either fingertip control spool valves or a Multifunction joystick. The most frequently used controls are in one place making operation straightforward thanks to clever ergonomics.



### The Efficient specification includes:

Dyna-6 Autodrive or Dyna-VT 40kph Eco  
 Command Control Armrest with 'T' lever  
 Closed Centre 110 l/min hydraulics  
 'QuadLink' front axle  
 Standard air conditioning  
 Mechanical spring cab suspension

### Spool valves

Mixed, 2 electronic and 1 or 2 mechanical spool valves  
 Electronic with fingertips (standard) or Multifunction joystick (optional)

### Optional

50 kph Eco Dyna-6 and Dyna-VT\*  
 OptiRide Plus cab suspension  
 Integrated front linkage and front PTO  
 150 l/min hydraulics (from MF 7619 onwards)  
 Radar & slip control  
 Air brakes  
 Radar and wheel slip control  
 Datatronic 4 CCD  
 Automatic air conditioning  
 SpeedSteer  
 AGCOMMAND ready  
 AutoGuide ready

\*Depending on market/legislation



The Command Control Armrest can be specified with a multifunction joystick. When not required for use with a loader, for example, using the optional Datatronic 4, the buttons can be programmed to operate other functions including:

- Engine speed memory A/B
- 4 WD
- Diff lock
- SV1 & SV2
- Headland turning
- AutoGuide
- SpeedSteer

This also applies to the Exclusive cab package on the following pages.







## Superior features for maximum productivity

The high specification 'Exclusive' cab package is aimed at the more intense, large scale operator looking for more advanced features that will ensure cost effective benefits for their business. The 'Exclusive' armrest provides numerous benefits including comfort and convenience when operating numerous, frequently used controls.

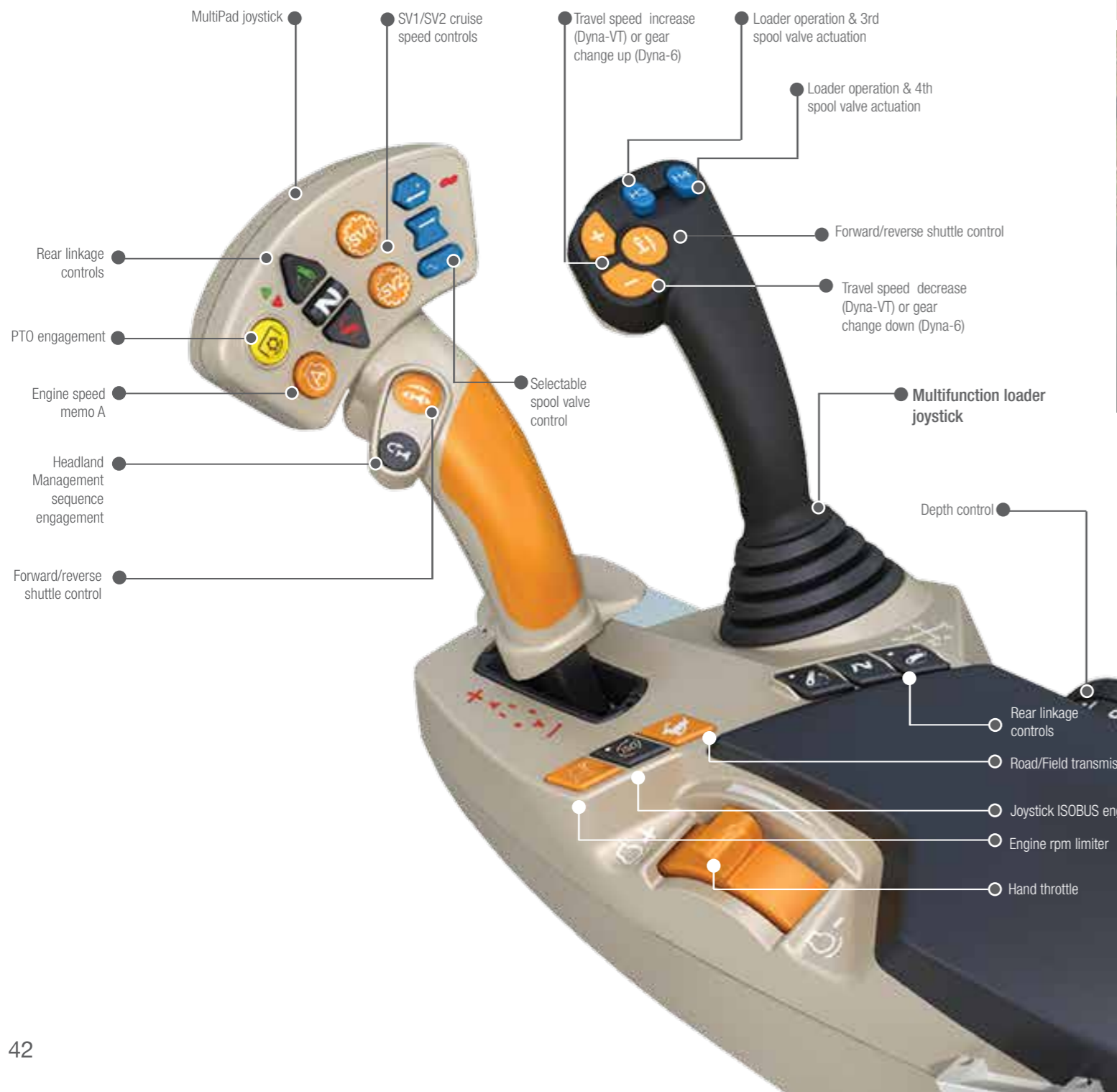

### The Exclusive specification includes:

- Dyna-6 Autodrive or Dyna-VT 40 kph Eco transmission
- Command Control Armrest with MultiPad lever
- Closed Centre 110 l/min hydraulics
- 'QuadLink' front axle
- OptiRide Plus cab suspension
- Datatronic 4 CCD with ISOBUS and camera provision
- Automatic air conditioning
- SpeedSteer

### Spool valves

Electronic spool valves with fingertips (base) or Multifunction joystick (optional)

### Optional

- 50 kph eco Dyna-6 and Dyna-VT\*
- Air brakes
- Integrated front linkage and front PTO
- 150 l/min hydraulics (From MF 7619 onwards)
- AGCOMMAND ready
- AutoGuide ready
- Full guidance available

\*Depending on market/legislation

Like the 'efficient' cab, the command control armrest is available with either fingertip spool valve controls or a multifunction joystick. The choice of fingertip controls and joystick means you can make your buying decision based on what suits your operational needs on a daily basis.





# Meeting operational demands precisely

With power, versatility and durability of operation as key design criteria, the PTO system has numerous options that meet all operational demands.



## Wide choice of PTO options

A wide choice of PTO options are available with standard PTO speeds at 2,000 rpm, where maximum power is achieved. With the benefit of a 'constant power' band of up to 600 rpm and the ability, with Dyna-VT, to precisely select any ground speed at the chosen engine speed, you can always achieve a perfect match of PTO speed, forward speed and power – with optimum economy.

Fully independent 540 Eco/1000 rpm or 1000/1000 Eco rpm PTO can be available.

Additional fender-mounted engagement PTO start/stop buttons allow the use of the PTO from outside the cab.

A convenient and safe way to handle applications such as filling a slurry tanker where the operator needs to be outside the cab.

## Power with economy

For lighter duty work, '540 Eco' or '1000 Eco' PTO speed is achieved at around 1600 engine rpm, further improving fuel economy and helping to reduce in-cab noise levels.

## Automated PTO control

In 'Auto' mode, the PTO is automatically disengaged when the linkage is raised (or when travelling at speeds above 25 km/h) and re-engaged when the linkage is lowered.

Further reducing the need for operator input, the Transmission Controller monitors and controls PTO engagement depending on load. This gives a smoother 'take-up', giving improved driver comfort and also helping to protect both implement and tractor from damage due to inappropriate engagement.

## Front linkage and PTO (optional)

Take full advantage of productivity gains when using both front/rear implement combinations.

- Benefit from real time savings - up to 30% when drilling
- 3.2 or 4 ton lift capacity and the option of front hydraulic couplers and front PTO for more productivity

## Differential locks and 4-wheel drive

The Transmission Controller also takes care of many of the normally repetitive tasks of 4-wheel drive and differential lock operation.

All MF 7600 series models have automatic 4WD and Differential lock modes.

For example, the system automatically disengages the differential lock when the implement is lifted and automatically re-engages when the implement is lowered.

4-wheel drive and differential lock can also be selected to engage and disengage automatically depending on steering angle\*.

\*Depending on specification



The PTO speed selection, PTO selector and 'Auto' actuation switches are conveniently positioned on the right-hand panel within easy reach of the operator.



Additional fender-mounted engagement PTO start/stop buttons allow the use of the PTO from outside the cab. You can also control the engine rpm using the PTO start/stop button, an excellent feature when using a slurry tanker for instance.



# Responsiveness is second nature

We have always been industry leaders when it comes to hydraulics and rear linkage control. Recently named the most influential agricultural innovation and milestone of our time by several independent farming magazines, Massey Ferguson's three-point linkage is the finest example of productivity, power and responsiveness, for the operator, in the field.



## Accurate draft control

Massey Ferguson's digital ELC system gives the highest standards of draft control with more accurate depth settings and better ground contour following. The result is more weight transfer, better traction, less wheel slip, reduced tyre wear and reduced fuel consumption whilst still maintaining greater output.

## Convenient controls

Frequently used controls and the ELC control panel are mounted near the operator for straightforward, accurate operation. The system incorporates advanced integrated features such as sensitivity, quick soil engagement and automatic drop speed as standard.

For faster implement attachment the rear linkage can also be operated from push buttons on each rear fender.

## Fast hydraulic response

The Closed Centre Load-Sensing (CCLS)\* hydraulic system provides up to 150 l/min oil flow for both linkage and external services with virtually instantaneous response, with no wasted power - or fuel.

Implement hook-up is simple, with 'decompression hydraulic couplers' that enable equipment to be connected and disconnected under pressure.

## Auxiliary spool valves

Between two and four electro-hydraulic valves are fitted as standard and up to five rear spool valves may be available if required, the Fingertip Spool Valve Management System enables complex equipment to be controlled with ease and precision.

## Power beyond

Built into the CCLS spool block is the 'Power beyond' facility, which is available for both front and rear of the tractor. Extra flow and return pipes provide oil flow directly from the pump, enabling additional remote spool valves to be connected.

## Standard Active Transport Control (ATC)

When driving across the headland or transporting heavy mounted equipment, implement 'bounce' can occur. Active Transport Control is a shock-absorbing system which minimises the 'pitching' action - automatically adjusting for different implement weights.

This gives smoother, safer, faster transport and, by reducing shock loads through the lift rams and hydraulic circuits, also minimises the risk of damage to the rear linkage and the implement.

## ATC and QuadLink

ATC operates in addition to the QuadLink suspended front axle to give exceptional stability when transporting or operating mounted equipment at speed, giving greater comfort, safety and productivity.

\*CCLS is an option on the Essential specification



## Highly specified rear axle and linkage

The rear axle and 3-point linkage are highly specified. Twin external lift rams, high visibility pick-up hitch and drawbar (depending on market), quick-attach hook top and lower links, external linkage control on both rear fenders, twin variable float telescopic stabilisers and three spool valves are all standard equipment. Rear linkage lift capacity can reach 9,300 kg depending on model specified.

\*Depending on market/legislation

## Integrated Front Linkage System (IFLS)

MF 7600 Series tractors are available with a fully integrated front linkage system.

Four front, hydraulic couplers provide hydraulic service for implements and with an overall lift capacity of up to 4,000 kg, the MF 7600 Series tractors' immense capability can easily handle heavy-duty applications.

## Exceptional braking performance

The MF 7600 Series has an extraordinarily powerful and highly efficient braking system. All models are fitted with oil immersed, power-assisted disc brakes which give reassuring, fade-free braking, even under heavy loads.

Optional factory-fitted pneumatic trailer brakes can be fitted, adding comfort and safety when driving with heavy loads at high speeds.



# Straightforward servicing - just how it should be

Servicing is straightforward and simple, taking the stress out of maintaining your tractor and leaving you with more time in the field. With service intervals increased by 25% to 500 hours, maintenance costs are substantially reduced.

The single piece bonnet lifts fully to allow excellent access for full servicing



The well proportioned cooling package is easy to access, clean and maintain. 90% of dust is removed naturally thanks to the suction from the cooling fan. The engine air filter is also very easy to access and clean.



Plenty of room to access radiators for cleaning



The cab air filter can be removed easily for cleaning

The AdBlue tank has been carefully positioned to improve insulation in high and low temperatures. Filling of both tanks is safe and convenient

The waisted bonnet and front axle design ensures comfortable access to the engine oil filters and oil dipstick





# Technology at your command

Our most advanced tractor now boasts the most innovative advancements in guidance and telemetry. Easy-to-use, reliable and sophisticated technology from AGCO is the key to providing optimum results for your business.



# AGCOMMAND

Your finger on the pulse at all times

The AGCOMMAND telemetry system from AGCO is ideal for large businesses and contractors. If you need consistent, concise information concerning your fleet at all times then AGCOMMAND is the perfect choice.

## AGCOMMAND Standard Plus

is a leading edge data recording and transmission tool that allows you to optimise fleet performance by monitoring and reporting vehicle position, history and status. Also, monitor operating costs and enhance productivity.

Every sixty seconds AGCOMMAND collects machine performance data and GPS location, this is then transmitted via the GSM network and is then viewable via your PC.

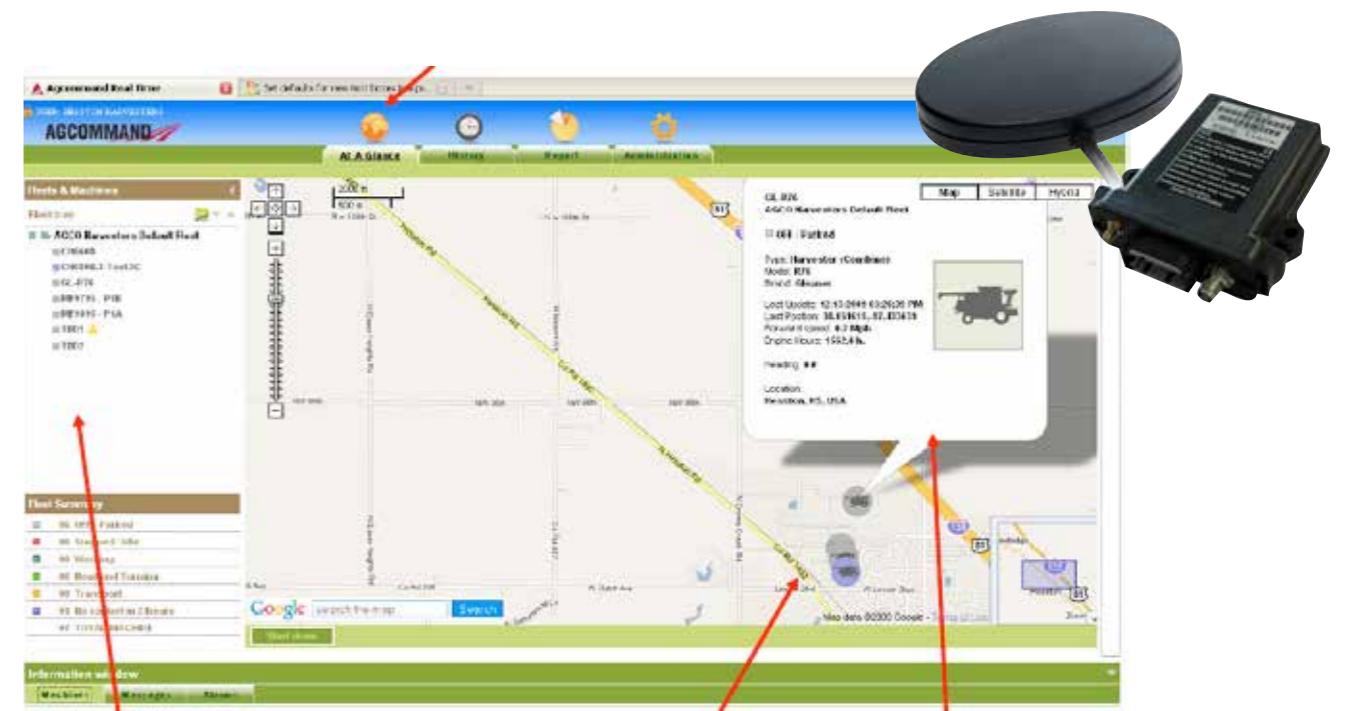

### System 150 Guidance solutions

The System 150 is a full featured, hands free steering system capable of delivering sub-metre, decimetre, and centimetre accuracy. System 150 is suitable for all applications where high levels of in-field driving accuracy are required such as primary and secondary cultivation, seeding and planting, mowing and chemical/fertiliser application.

- Satellite controlled steering system for precise, automated machine navigation
- The System 150 steering system allows the elimination of misses and overlaps
- Best in class accuracy at all correction levels
- Superior compensation for rolling terrain
- Lightweight and portable for simple transfer between compatible machines
- Liquid Rate Control option (Optional ASC-10 Auto Section Control required)

### System 150 features

- GX-45 Console
- Rugged housing, built for the field
- Colour, 5-inch diagonal screen
- Quick action keys for simple operation
- Visual indicators include: area applied, speed, row number and satellite information
- Convenient USB port for data transfer

### AGI-3 Receiver

- Multi-constellation support for GPS and GLONASS Satellites
- Support for EGNOS and OmniSTAR VBS and XP / HP correction signals
- Support for Real-Time Kinetic (RTK) Base station / network and GSM networks
- Integrated inertial sensors provide unmatched accuracy

### Guidance patterns

- AB lines
  - Identical curves
  - Adaptive curves
  - Centre pivot
- Viewing perspective
- Overhead view
  - Perspective view
  - North Up view

### Additional features

- Create and save field boundaries
- Create and save coverage maps
- End of row alarms
- Radar speed output for external controllers
- GPS signal output
- Export PDF coverage report
- Import and export boundary and coverage files
- USB Port for data transfer
- Automatic section and rate control for application equipment (with optional ASC-10 controller) and compatible implements

### Features and Benefits

- **Near Real Time Access** – AGCOMMAND Standard Plus collects and transmits data providing accurate and precise information regarding machine performance and location optimising machine utilisation and efficiency
- **Fully Automatic Data collecting and Transfer** – AGCOMMAND Standard Plus requires no operator input, the operator can concentrate on the task in hand maximising in field performance whilst the data is continuously transferred
- **Universal Installation** – AGCOMMAND Standard Plus is not limited to AGCO branded machines and vehicles
- **Alarms** – AGCOMMAND GEO-fences allow the customer to monitor machine position and check that the machine is working in the correct location. Service alarms allow routine maintenance to be planned and actioned with a minimum impact to machine productivity
- **Maintenance** – AGCOMMAND allows the requirements for machine maintenance to be directly monitored and managed by the customer or passed over to the dealer
- **Maps** – AGCOMMAND provides maps showing a machines working history - historic locations, area worked, travel patterns, etc., allowing productivity to be measured in specific fields or over a specific length of time
- **Comparisons** – AGCOMMAND allows the direct comparison of the performance and efficiency of up to five machines in the same fleet working in any location or application
- **Reports** – AGCOMMAND allows a number of reports to be generated, ranging from individual field reports up to a full season efficiency report allowing productivity to be studied and maximised
- **AGCOMMAND Advanced** - For those customers wishing to receive minute-by-minute updates plus an abundance of extra information to assist their business with data capture





# Ensure a cost effective future for your business with

It makes good business sense to plan for the unexpected and where machinery is concerned, there's no price on complete peace-of-mind. Secure your assets with a **manager** Service and Extended Warranty Plan.

**manager** Service and Extended Warranty Plan\* is a complete package aimed at providing total care for your tractor including routine maintenance, repair cover and full AGCO backed warranty. This fully-backed plan will cover critical components such as:

- Engine and transmission
- Hydraulics
- PTO
- Steering
- Electronics
- Cab and controls
- Axles

#### Assurance for the life of the machine

You can be assured of preventative maintenance using the latest technology and professionally trained technicians. With years of experience they are on hand to ensure that your machine runs at optimum performance.

All of this will be carried out according to a strict maintenance schedule supplied by Massey Ferguson.

With a **manager** plan and through this preventative maintenance, your machine will maintain excellent productivity throughout its long working life. The most important aspect of this package is that you will never incur any unexpected additional costs.

It is possible to cut the cost of maintaining your machine through preventative maintenance and maintenance, thereby reducing long-term ownership costs and securing a productive future for your business.

#### Tailored specifically for you

**manager** has been designed to cater for your individual needs. Cover is available for up to 5 years or 6,000 hours, depending on your requirements. Available at initial point of sale or, for added flexibility, you can choose to take on a **manager** plan any time up to twelve months after machine registration.

Your dealer will prepare the servicing plan and can tailor it to last up to a maximum of 10,000 hours.

By choosing a **manager** Service and Extended Warranty Plan, not only are you assured of complete peace-of-mind for you and your business but also a higher residual value for your machinery, full dealer history and genuine AGCO Parts, inside and out.

For more information on the **manager** Service and Extended Warranty Plan, speak to your Massey Ferguson dealer.

\***manager** Service and Extended Warranty Plan may not be available or may be market dependant. Please contact your Massey Ferguson dealer to check availability in your area. Terms and conditions apply.





# Customer Support

AGCO Customer Support...providing local service to the global brand



Massey Ferguson is a true global brand with machines operating all over the world, from revolutionary “little grey fergie” tractors to the latest high-tech tractors and combines. Have you ever wondered how we continue to provide industry-leading parts and service support to such a vast array of machines and technologies across the globe?

Behind every Massey Ferguson machine is the powerful aftersales support of AGCO's Customer Support organisation.

Our main aim is to ensure that every machine - old or new - is fully supported locally, offering every Massey Ferguson owner:

- The best service in the industry
- Low cost of ownership
- A reliable and durable machine
- Minimum machine downtime
- A high resale value

### State-of-the-art warehousing and logistics from AGCO Parts

Of course, every Massey Ferguson dealer is fully backed-up by the AGCO Customer Support organisation which provides industry-leading parts supply through AGCO Parts' state-of-the-art warehousing and logistics. With outstanding service levels, overnight delivery and inventory covering all Massey Ferguson machines - even those over 10 years old - we only ever supply genuine parts, and we guarantee the right fit, first time.

### The right aftersales solution whatever the age of machine

Whatever the age of Massey Ferguson machine, AGCO Customer Support has the right aftersales solution to save time & money, providing appropriate, affordable and reliable servicing and maintenance solutions in every situation.

### Practical local support where you need it

AGCO places great emphasis on providing the best service to our Massey Ferguson dealers and this extends beyond the exceptional servicing and maintenance solutions and parts supply:

- Expert training and specialist equipment
- Advanced diagnostic techniques
- Information retrieval technology to communicate the very latest parts and service information
- Highly skilled technical support groups

With aftersales support from AGCO Customer Support, it's not just about supplying a filter or doing an oil change. It's about providing the best solution to our customers' needs, wrapped up with industry-leading parts and service support.



## Standard and optional equipment by cab type

	Essential	Efficient	Exclusive
<b>Engine</b>			
6 Cylinder AGCO SISU Power Stage 3b	●	●	●
Selective Catalytic Reduction (SCR) technology Generation 2	●	●	●
EEM Engine with memorised speed control	-	●	●
Engine Block Heater	○	○	○
<b>Transmission</b>			
Power Control shuttle	●	●	●
Right hand shuttle	○*	○	●
T lever on Control Centre	●	-	-
T lever on Command Control Armrest	-	●	-
MultiPad lever on Command Control Armrest	-	-	●
Dyna-4 - 40kph - Speedmatching & Autodrive	●	-	-
Dyna-6 - 40kph Eco - Speedmatching & Autodrive	○	●	●
Dyna-6 - 50kph** Eco - Speedmatching & Autodrive	○	○	○
Supercreeper * or creeper	○	○	○
Dyna-VT 40kph Super Eco with Dynamic Tractor Management (DTM)	-	○	○
Dyna-VT 50kph** Eco with Dynamic Tractor Management (DTM)	-	○	○
Cruise speed control	-	●	●
ParkLock***	-	○	○
<b>Operator environment</b>			
Standard Air Conditioning with manual adjustment	●	●	-
Automatic Air Conditioning / climate control	-	○	●
Cool box	●	●	●
Automatic Air Suspended Swivel Seat	●	●	-
Super Deluxe Air Suspended Dynamic Damping System Seat.	-	○	●
Auxiliary Seat with Seatbelt	●	●	●
Radio predisposal	●	-	-
Radio - MP3 - SD card slot - USB	○	●	-
Radio, CD, MP3, Equalizer, Bluetooth, USB & Front Aux.	-	○	●
Telescopic Large Side Mirrors	●	●	-
Telescopic Large Side Mirrors with Electric Adjustment and de-icing	-	○	●
2 opening doors	●	●	●
Mechanical Cab Suspension	○	●	-
OptiRide Plus Cab Suspension semi-active	-	○	●
Visio Roof *	○	○	○
Roof hatch *	○	○	○
Radar and slip control	○	○	●
CCD/Datatronic 4 with video and isobus capability	-	○	●
Trailer steering axle management	-	○	○
Dual Control	-	○	●
Headland Management System	-	○	●
Automatic steering / Autoguidance	-	○	●
Speedsteer	-	○	●
AGCOMMAND	○	○	○

	Essential	Efficient	Exclusive
<b>Chassis and hydraulics</b>			
Mechanical controls of spool valves	●	-	-
Electrical and mechanical controls of spool valves	-	●	-
Electrical controls of spoolvalves	-	-	●
Multifunction joystick	-	○	○
Loader ready tractor with Multifunction joystick	○*	○	○
Electronic linkage controls with Active Transport Control	●	●	●
Auto PTO function	●	●	●
Auto 4-Wheel-Drive and Auto DiffLock functions	●	●	●
Telescopic stabilisers	●	●	●
Automatic stabilisers	○	○	○
Integrated front linkage system	○	○	○
Integrated Front PTO	○	○	○
<b>Electrical equipment</b>			
Automatic Isolator switch	○	○	○
ISO signal connector	-	●	●
External lift control on fenders	●	●	●
External PTO start/stop control on fender	●	●	●
Xenon lighting	○	○	○
<b>Other equipment (Specifications may vary by market)</b>			
Quadlink - Suspended front axle	○	○*/●	●
Pivoting front fenders	○	○	●
Additional in-cab heater	○	○	○
Hydraulic trailer brake	○	○	○
Pneumatic trailer brake	○	○	○

- Not available
- Standard specification
- Optional
- \* MF 7614 to MF 7618 Dyna-6
- \*\* Depending on market legislation
- \*\*\* MF 7619 to MF 7626

Every effort has been made to ensure that the information contained in this publication is as accurate and current as possible. However, inaccuracies, errors or omissions may occur and details of the specifications may be changed at any time without notice. Therefore, all specifications should be confirmed with your Massey Ferguson Dealer or Distributor prior to any purchase.



Engine		MF 7614	MF 7615	MF 7616	MF 7618	MF 7619	MF 7620	MF 7622	MF 7624	MF 7626
Engine type		AGCO SISU POWER e <sup>3</sup> SCR								
no. of cylinders/no. of valves/Capacity	litre/no./cm <sup>3</sup>	6 / 4 / 6600	6 / 4 / 6600	6 / 4 / 6600	6 / 4 / 6600	6 / 4 / 6600	6 / 4 / 6600	6 / 4 / 6600 (Dyna-VT) 6 / 4 / 7400 (Dyna-6)	6 / 4 / 7400	6 / 4 / 7400
Bore / Stroke		108/120	108/120	108/120	108/120	108/120	108/120	108/120 (Dyna-VT) 108/134 (Dyna-6)	108/134	108/134
Aspiration		Turbo Intercooled								
Injection type		Common rail								
Fan type - Transmission Dyna-4		Visco-static	Viscostatic		-	-	-	-	-	-
Fan type - Transmission Dyna-6 & Dyna-VT		-	Vistronic	Vistronic	Vistronic	Vistronic	Vistronic	Vistronic	Vistronic	Vistronic
Maximum hp @ 1950 rpm	ISO hp (kW)	140 (103)	150(110)	160(118)	175(129)	185(136)	200(147)	215(158)	235(173)	255(188)
Rated hp @ 2100 rpm	ISO hp (kW)	130(96)	140 (103)	150(110)	165(121)	170(125)	185(136)	200(147)	220(162)	240(176)
Maximum torque @ 1500 rpm	Nm	645	660	677	740	830	880	943	1030	1049
Specific fuel consumption*	g/kWh	192	192	192	192	192	192	192	192	192
Fuel tank capacity	litres	310	310	310	310	430	430	430	430	430
Adblue tank capacity	litres	30	30	30	30	40	40	40	40	40
Service interval	hours	500	500	500	500	500	500	500	500	500

#### Transmission Dyna-4 40kph

Number of gears	Fwd x Rev	16 x 16	16 x 16	-	-	-	-	-	-	-
Min. speed @ 1400 rpm	kph	1.3	1.3	-	-	-	-	-	-	-
No of speeds with creeper/supercreeper	Fwd x Rev	24 x 24 / 32 x 32	24 x 24 / 32 x 32	-	-	-	-	-	-	-
Min. speed @ 1400 rpm with creeper/supercreeper	kph	0,33 / 0,09	0,33 / 0,09	-	-	-	-	-	-	-
Maximum power with EPM	hp (kW)	155(114)	165(121)	-	-	-	-	-	-	-
Max. power available @ PTO shaft (OECD, accuracy +/- 3%)	hp (kW)	115(85)	125(92)	-	-	-	-	-	-	-
Maximum torque with EPM	Nm	660	677	-	-	-	-	-	-	-

#### Transmission Dyna 6 40 kph Eco or 50 kph\*\* Eco

Number of gears	Fwd x Rev	-	24x24	24x24	24x24	24x24	24x24	24x24	24x24	24x24
Min. speed @ 1400 rpm	kph	-	1.03	1.03	1.03	1.1	1.1	1.1	1.1	1.1
No of speeds with creeper/supercreeper	Fwd x Rev	-	36x36/48x48	36x36/48x48	36x36/48x48	36x36/ -	36x36/ -	36x36/ -	36x36/ -	36x36/ -
Min. speed with creeper / supercreeper	kph	-	0,26/0,07	0,26/0,07	0,26/ 0,07	0,26/ -	0,26/ -	0,26/ -	0,26/ -	0,26/ -
40 kph Eco at engine speed	rpm	-	1800	1800	1800	1800	1800	1800	1800	1800
50 kph** Eco at engine speed	rpm	-	1950	1950	1950	1850	1850	1850	1850	1850
Maximum power with EPM	hp (kW)	-	175(129)	185(136)	200(147)	210(155)	220(162)	240(177)	260(191)	280(206)
Max. power available @ PTO shaft (OECD, accuracy +/- 3%)	hp (kW)	-	135(99)	140(103)	155(114)	165(121)	180(132)	195(144)	210(155)	230(169)
Maximum torque with EPM	Nm	-	745	790	840	925	980	1035	1120	1145

#### Transmission - Dyna VT

Type		-	Dyna-VT with Power Control: Stepless, Continuously Variable Transmission with Dynamic Tractor Management (DTM)							-
Field speed range		0,03 - 28 Kph Forward and 0,03 - 16 Kph Reverse								-
Road speed range		0,03 - 50 Kph* Forward and 0,03 - 38 Kph Reverse								-
Max. power available @ PTO shaft (OECD, accuracy +/- 3%)	hp (kW)	-	130 (96)	140 (103)	150 (110)	165 (121)	180 (132)	195 (144)	205 (151)	-

– = Not applicable/available

\* = Manufacturer's testing

\*\* = Depending on market legislation

⊕ = ISO TR14396

Rear Linkage and hydraulics		MF 7614	MF 7615	MF 7616	MF 7618	MF 7619	MF 7620	MF 7622	MF 7624	MF 7626
Lower links type	Category	3	3	3	3	3	3	3	3	3
Maximum lift capacity, at link end	Kg	7100	7100/8600	7100/8100/8600	8100/8600	9300	9300	9300	9300	9300
Hydraulic type 1		Closed Centre Load Sensing								
Maximum Flow	rpm	110	110	110	110	110/150	110/150	110/150	110/150	110/150
Maximum pressure	bars	200	200	200	200	200	200	200	200	200
Maximum no of rear spool valves		4	4	4	4	4/5(Dyna6)	4/5(Dyna6)	4/5(Dyna6)	4/5(Dyna6)	5
Hydraulic type 2		Open centre (essential)	Open centre (essential)	Open centre (essential)	Open centre (essential)	-	-	-	-	-
Maximum Flow	litres/minute	58	58	58	-	-	-	-	-	-
Maximum pressure		200	200	200	-	-	-	-	-	-
Maximum no of rear spool valves		4	4	4	-	-	-	-	-	-
<b>Power Take-Off (Rear)</b>										
Engine speed @		1598								
540/1000	rpm	1980 / 2030	1980 / 2030	1980 / 2030	1980 / 2030	1890/2000	1890/2000	1890/2000	1890/2000	1890/2000
540/540Eco/1000 Dyna 6	rpm	-	-	-	-	1890/1520/2000	1890/1520/2000	1890/1520/2000	1890/1520/1930	1890/1520/1930
540/540Eco/1000 DynaVT	rpm	-	1930 / 1490 / 1900							-
540/540Eco/1000/1000Eco	rpm	1980 / 1530 / 2030 / 1570				-	-	-	-	-
540Eco/1000/1000Eco	rpm	-	-	-	-	1520/1930/1600				
Shaft diameter	inches	1 3/8	1 3/8	1 3/8	1 3/8	1 3/8	1 3/8	1 3/8	1 3/8	1 3/8

#### Front linkage and Front Power Take-Off

Lower links type		2	2	2	2 / 3	3	3	3	3	3
Maximum lift capacity, at link end	kg	3200	3200	3200	3200/4000	4000	4000	4000	4000	4000
Maximum No of front spool valves		2	2	2	2	2	2	2	2	2
Engine speed @ 1000 front PTO speed		1920	1920	1920	1920	1920	1920	1920	1920	1920

#### Wheels and Tyres (Full range available. Please consult your Dealer)

Front	m	480/70R28	480/70R28	480/70R28	480/70R28	480/70R30	480/70R30	480/70R30	480/70R30	480/70R30
Rear	m	580/70R38	580/70R38	580/70R38	580/70R38	620/70R42	620/70R42	620/70R42	620/70R42	620/70R42

#### Track adjustments (with standard wheels and tyres)

Front Track adjustment (with tyres mentioned above)	m	1.92	1.97	1.97	1.97	2.13	2.13	2.13	2.13	2.13
Rear Track adjustment (with tyres mentioned above)		2.02	2.0	2.0	2.00	2.08	2.08	2.32	2.32	2.32

#### Weights and dimensions (with standard wheels and tyres, without ballast, 4WD model, less fuel)

Weight	kg	5800	6200	6200	6300	7000	7200	7400	7400	7500
Overall height - from rear axle centerline to top of the roof	m	2.11	2.11	2.11	2.11	2.19	2.19	2.19	2.19	2.19
Overall height - over cab	m	3.03	3.03	3.03	3.03	3.17	3.17	3.17	3.17	3.17
Overall length - from weight carrier to lower link ends	m	4.90	4.90	4.90	4.90	5.09	5.09	5.09	5.09	5.09
Wheelbase	m	2.88	2.88	2.88	2.88	3.00	3.00	3.00	3.00	3.00
Max. gross vehicle weight	kg	9250	11500	11500	11500	12500	12500	13000	13000	13000
Cab noise level	dBa	70	70	70	70	70	70	70	70	70

Every effort has been made to ensure that the information contained in this publication is as accurate and current as possible.

However, inaccuracies, errors or omissions may occur and details of the specifications may be changed at any time without notice.

Therefore, all specifications should be confirmed with your Massey Ferguson Dealer or Distributor prior to any purchase.



# MF 7600 highlights

Here's a quick reminder of some of the advanced features of the MF 7600 Series tractors that further enhance their place firmly within the high horsepower sector.

- 01** Nine models across the range from 140 to 255 horsepower, all with six cylinder, AGCO SISU Power e<sup>3</sup> SCR engines.
- 02** All models offer a combination of renowned characteristics as well as new technology and significant ergonomic features that will make day-to-day operation easier and more straightforward.
- 03** The MF 7600 Series is available with a choice of transmissions for a wide range of applications. The Dyna-4 transmission is highly efficient and now comes with lever and pedal modes. Providing 'pedal-free', automatic changing and two driving modes.
- 04** Dyna-4 and 6 also now come with Engine Power Management, automatically providing up to an extra 25 horsepower and improving output in a range of applications.
- 05** Precise control and ultimate efficiency comes from the continuously variable Dyna-VT transmission with Dynamic Tractor Management. DTM automatically adjusts the engine speed according to load. An excellent feature especially in transport applications.
- 06** The MF 7600 Series can be specified with 'Essential', 'Efficient' or 'Exclusive' specification levels. Depending on your sector, there are options that will suit your requirements perfectly. The cab has been designed to meet every need of the operator. A new dashboard, fully adjustable steering column, more leg room and cool box are just some of the in-cab comforts.
- 07** Controls have been ergonomically designed to ensure you get maximum productivity from all the controls. A new control format on the right-hand pillar holds the more commonly used switches and buttons.
- 08** Optional QuadLink front axle suspension can be switched on or off to optimise quality of work and field performance whatever the conditions.
- 09** All models come with a choice of cab suspension - mechanical or electro-hydraulic fully adjustable OptiRide Plus.
- 10** The closed centre auxiliary hydraulic system has up to 150 l/min pump flow, allowing for excellent hydraulic flow when you need it most.

