

# New Rex

The fruit of innovation



*Landini*<sup>®</sup>

# NEW REX, TRUE SPECIALIST

New *Rex*, here comes the new generation of specialists par excellence. The whole range has been fully revamped to provide ultimate performance, improved ergonomics and maximum comfort.

The renovation work consists in a redesigned cab roof, a restyling of tilting hood featuring integrated, nicely shaped headlights, and a fully revamped cockpit, where a new and more ergonomic control layout provides maximum roominess for the operator, thus responding in an increasingly more professional way to the real requirements voiced by the specialized farming sphere.

An optimized PTO engagement, an increasingly more accurate adjustment of power lift sensitivity, the availability of front power lift and PTO as well as new hydraulic features underscore the evolution of this range. Moreover, a tighter steering radius further boosts performance and productivity where space is at a premium.



Thanks to its pioneering features the *Rex* series, available in two versions, namely cab and platform, is an outstanding all-round performer providing maximum reliability, utmost versatility and tip-top manoeuvrability in any soil condition, in any specialized crop, with any sort of implements.

The new *Rex* series has been completely renovated to offer three different transmissions combined with a variety of transaxles, different front and rear axles solutions and different wheelbase and track sizes. This is why the *Rex* tractors are proposed in three different versions designed for a wide variety of applications:

**F model** (narrow orchard) ideal for work in small-sized orchards.

**GE model** (low orchard) ideal for work in low orchard plantations.

**GT model** (large orchard) for use in standard orchards and in open field.

Besides featuring new pioneering technologies and additional options, the new *Rex* series is also equipped with new Tier3-compliant 3-and 4 cylinder *Turbo Aftercooler Perkins* engines. A product range combining performance, reliability, comfort and design. This is the great strength of *Rex* tractors.



**Landini**<sup>®</sup>

## KEY FEATURES AND ADVANTAGES

- › MODERN TRACTOR FEATURING A VERY ATTRACTIVE LOOK
- › MAXIMUM ROOMINESS. UTMOST COMFORT AND TIP-TOP PRODUCTIVITY
- › ULTIMATE ALL-ROUND VISIBILITY
- › MORE COMFORTABLE LIVING-SPACE AND BETTER WORK CONDITIONS
- › ERGONOMIC CONTROL LAYOUT FOR UTMOST DRIVING EASINESS AND COMFORT



### NEW CAB ROOF

EXCELLENT SOUNDPROOFING OF THE DRIVING AREA THANKS TO THE OPTIMUM DEADENING FEATURES PROVIDED BY SPECIFIC MATERIALS MAKING UP THE CAB. AN EXTREMELY COMFORTABLE WORK ENVIRONMENT IS ALSO GUARANTEED BY AN IMPROVED AIR CONDITIONING SYSTEM INSTALLED UNDER THE CAB ROOF AND INTEGRATED BY A FILTER DESIGNED TO PURIFY THE AIR, THUS SAFEGUARDING THE OPERATORS' HEALTH IN ORCHARDS AND VINEYARDS PARTICULARLY WHEN PEST CONTROL TREATMENTS ARE APPLIED. VISIBILITY DURING NIGHT WORK IS GUARANTEED BY 4 POWERFUL HEADLIGHTS. > FIG. A

### ALL-ROUND VISIBILITY

THE REX SERIES HAS BEEN DESIGNED AND CONCEIVED TO ENSURE AN ULTIMATE ALL-ROUND VISIBILITY. THE SLOPING BONNET ALLOWS FOR OPTIMUM VISIBILITY AT THE FRONT, WHILE THE IMPROVED VISIBILITY AT THE REAR ALLOWS FOR TOTAL AND PRECISE IMPLEMENTS CONTROL, THUS MAKING WORK EASIER BESIDES BOOSTING PRODUCTIVITY. > FIG. B



## MODERN DESIGN, OPTIMUM VISIBILITY, DE LUXE COMFORT

Modern and attracting design with low-profile bonnet and soft-rounded lines without sharp edges. A swift glance to the relevant design is sufficient to get an immediate idea of the high specialization degree the new Rex series has achieved.

The sloping shape of the bonnet allows for optimum visibility at the front and also lowers the height of the machine, allowing it to work under the trees and reducing the possibility of damaging the crops to the minimum.

Rounded mudguards with rear lights in a protected position reducing the size of the machine and facilitating work without the risk of ruining branches or fruits.

Inside the "Total View" cab a fresh air is breathed. An improved and more ergonomic position of control levers, pedals and joystick controlling the spool valves, as well as the new pneumatic suspension seat and the new height adjustable steering wheel make driving a pleasure. Furthermore, all controls, having been positioned in a logical and simple way, can be easily reached so as to provide maximum operator's comfort, enhanced productivity and easier tractor operation.

An efficient air conditioning system together with a new way of pressurizing and a consequent noise level reduction, make the cab interior an extremely pleasant place of work in all seasons, silent and well away from dust and noise.

The result being a generously sized and extremely comfortable driving area making work increasingly easier and safer.

### OPENABLE FRONT AND REAR WINDSCREEN

NATURAL VENTILATION IS PROVIDED BY THE LARGE FRONT AND REAR PUSH-OPEN WINDSCREENS. > FIG. C



## GENEROUSLY SIZED, SPACIOUS PLATFORM FOR UTMOST OPERATOR'S COMFORT, IMPROVED AND MORE ERGONOMIC CONTROL LAYOUT

The platform version has also been revamped and featuring a new *look*. The sloping shape of the bonnet and the rounded mudguards, together with a foldable safety frame allow for easier work under awning cultivations thus avoiding any damage to branches or fruits.

The generously sized and comfortable platform is mounted on *silent-blocks* that isolate the driving area from vibrations, making work less tiring and stressing for the operator.

All controls are easily reached and positioned in a simple yet logical way.

Their position has been determined in accordance with the specific requests of the people who actually use the tractors.

Although the machine is small in size, the access to the driving area is very easy. The space between dashboard and driving seat as well as a more ergonomic control layout allow the operator the utmost freedom of movement, the result being an extremely comfortable and safe driving area which adds to an all-round visibility for maximum productivity.



### STEERING WHEEL

WITH 3 SPOKES AND A MORE MODERN DESIGN, IN ACCORDANCE WITH THE CURRENT STATE-OF-THE ART, TO COPE WITH THE DIFFERENT DRIVING CONDITIONS WORLDWIDE. > FIG. A

### ERGONOMIC DRIVING SEAT

THE DRIVING SEAT COMES WITH A COMFORTABLE BACK AND IS ADJUSTABLE IN HEIGHT AND SLANT, WITH SPRINGS THAT CAN BE ADAPTED TO SUIT THE DRIVER'S WEIGHT THUS ENHANCING DRIVING COMFORT. > FIG. B

## KEY FEATURES AND ADVANTAGES

- › ROOMY AND COMFORTABLE PLATFORM. UTMOST COMFORT AND PRODUCTIVITY AT WORK
- › EASY ACCESS TO DRIVING AREA WITHOUT IMPEDIMENTS
- › ALL-ROUND VISIBILITY AT THE FRONT AND REAR
- › ERGONOMICALLY POSITIONED CONTROLS TO PROVIDE UTMOST OPERATION EASINESS AND DRIVING COMFORT



## DASHBOARD WITH DIGITAL DISPLAY AND TRACTOR COMPUTER

THE DASHBOARD WITH DIGITAL DISPLAY PROVIDES PRECISE INDICATIONS ABOUT TRACTOR OPERATION ON A REAL TIME BASIS.

DIGITAL INDICATORS GIVE PRECISE AND IMMEDIATE DETAILS ABOUT THE ENGINE RATE AND THE PTO SPEED. ANALOG INDICATOR IN THE CENTRE GIVES AN IMMEDIATE AND PRECISE INFORMATION ABOUT ENGINE REVOLUTIONS, WHILE ANALOG INDICATORS ON WHITE BACKGROUND SHOW THE FUEL LEVEL AND ENGINE COOLANT TEMPERATURE. THE INSTRUMENT COMES COMPLETE WITH A COMPUTER PROVIDING DETAILED INFORMATION ABOUT AREA WORKED, DISTANCE COVERED, SIZE OF THE IMPLEMENT AND TYPE OF REAR TYRES USED TO FACILITATE WORK AND OPTIMIZE TRACTOR UTILISATION FOR HIGHER PRODUCTIVITY. > FIG. C



## KEY FEATURES AND ADVANTAGES

- › NEW AFTERCOOLER ENGINES ON REX 70 AND 85FIGE, REX 100, 110 AND 120 FIGE/IGT MODELS
- › BETTER COMBUSTION, HIGHER EFFICIENCY AND "CLEAN" EXHAUST GASES"
- › UTMOST MIXING AND INJECTION EFFICIENCY
- › INCREASED PERFORMANCE IN THE MORE COMMONLY USED ENGINE RATES BETWEEN 1800 AND 2200 REVIMIN.
- › LOWER FUEL CONSUMPTION AND GREATER ECONOMY
- › MAXIMUM EFFICIENCY IN ALL LOAD CONDITIONS, ENGINES ALWAYS LIVELY
- › EXTREMELY FLEXIBLE ENGINE PERFORMANCE



## ENGINE: SALIENT FEATURES

**CRANKSHAFT:** IN LONG-LASTING HIGH-PERFORMANCE MOLYBDENUM STEEL ALLOY. THE 4-CYLINDER ENGINES ARE EQUIPPED WITH BALANCING WEIGHTS THAT REDUCE THE VIBRATIONS.

**ENGINE OIL RADIATOR:** THE ENGINE COOLING RADIATOR IS INSTALLED ON THE L.H SIDE OF THE ENGINE BLOCK. THIS DOES AWAY WITH PIPES AND FITTINGS AND STOPS LEAKS FROM OCCURRING.

**TURBOCOMPRESSOR AFTERCOOLER:** THE TURBO-COMPRESSOR ALLOWS THE ENGINE TO ACHIEVE TIP-TOP POWER AND TORQUE PERFORMANCE. SINCE THE COMPRESSED AIR THAT ENTERS THE TURBO-COMPRESSOR SYSTEM IS COOLED, THE OXYGEN MOLECULES BECOME CONCENTRATED TO A GREATER DEGREE. THIS ACHIEVES BETTER AIR/FUEL MIXING, THUS IMPROVING THE COMBUSTION EFFICIENCY AND INCREASING THE PERFORMANCE.

**FUEL INJECTION SYSTEM:** A ROTATING INJECTION PUMP ENSURES CORRECT FUEL INJECTION. INJECTORS WITH 5 HOLES ENSURE OPTIMIZED FUEL COMBUSTION, THUS GUARANTEEING THE PERFORMANCE AND EFFICIENCY OF THE INJECTION SYSTEM.

**COOLING:** THE COOLANT PUMP IS DRIVEN BY THE GEARS OF THE TIMING SYSTEM. THE COOLANT FLOW AND COOLING FAN COOL THE ENGINE IN AN OPTIMAL WAY AND ENSURE AN EXCELLENT PERFORMANCE.

**DRY AIR FILTER WITH DOUBLE CARTRIDGE:** ENSURES THAT THE AIR IS FILTERED CORRECTLY. AN INDICATOR LIGHT ON THE DASHBOARD WARNS THE OPERATOR WHEN THE FILTERING ELEMENTS MUST BE CLEANED OR REPLACED. MAINTENANCE IS QUICK AND SIMPLE: JUST OPEN THE BONNET TO ACCESS THE FILTER.





## TIER 3 ENGINES. MORE POWER, MORE PRODUCTIVITY



A completely new range of environment-friendly engines that comply with the new low exhaust specifications as required by the TIER 3 standards.

These *Perkins* 1100D engines have been specially designed for agricultural use with modern features and ground-breaking technical solutions.

The three- and four-cylinder engines in both aspirated and turbocharged versions are the Perkins answer to the increasingly more stringent standards governing harmful emissions.

The *Rex* series comes with 7 engine models covering a power range of 74 (naturally aspirated), 83 (turbo), 68, 79, 92,5, 102 and 110 HP/ISO (*Turbo Aftercooler*).

Excellent air-fuel mixing is guaranteed thanks to particular technological innovations: the result is better combustion and efficiency, higher power and torque with lower running costs and respect of the environment.

The new *Perkins Turbo Aftercooler* engines already installed in certain models of the range offer a further level of performance and power for an even higher degree of productivity.

The full tilting hood provides easy access to the engine for routine service and daily maintenance. > FIG. B



### FUEL TANK

THE FUEL TANK IS INSTALLED BEHIND THE PASSENGER SEAT WITH FILLER CONVENIENTLY POSITIONED TO ALLOW EASY AND QUICK REFUELLING. THIS TANK COMES TOGETHER WITH AN ADDITIONAL FUEL TANK FITTED UNDER THE PLATFORM FOR THE LONGEST POSSIBLE AUTONOMY.

> FIG. A



# THE PLUSES OF THE NEW REX

## + COMFORT

- Much more silent pressurized cab.
- New control levers, new pedals, new joystick for spool valves control, new steering wheel.
- Enhanced rear visibility for safer implement operation.

## + DESIGN

- New cab roof.
- New control console.
- New design for hood, front grille and headlights.

## + PERFORMANCE

- New Turbo Aftercooler Perkins engines:
- More powerful range top model: 110,2 HP.
- More comprehensive and more powerful tractor range.



- Increasingly more accurate adjustment of power lift sensitivity

## + PRODUCTIVITY

- 20% tighter steering radius.



## A MINISITE DEDICATED TO THE NEW REX

This is one of the initiatives developed by Landini to launch the new Landini Rex series, a range par excellence designed for specialized crops, orchards and vineyards.

Only recently launched on the market, the Rex series is presented in the mini-site with a wealth of interactive tools: a comprehensive photo gallery where the tractor is viewed from all possible angles, video clips of the tractor at work, an all-round panorama as well as the technical data sheet and a space dedicated to testimonials. All this is presented in an extremely attractive way, with a lively, modern musical background that faithfully expresses the dynamic farsighted spirit of the new tractor series.

The Rex mini-site is just another step forwards in Argo Tractors' communication and marketing strategy, where the end user is assisted by a simple, yet efficient and handy tools that bring the virtual world much nearer to the real one.

The mini-site dedicated to the Rex series can be downloaded from the following link: [www.landini.it/rex](http://www.landini.it/rex).



### + OPTIONS

#### New hydraulic features:

- Control valve with electro-hydraulically controlled three-ways flow divider.
- Double pump with 1 front spool valve activated by relevant knob.
- Triple pump with 3 front spool valves controlled by joystick.
- Split rear and front hydraulic taps.
- Utmost hydraulic flexibility, with possibility of offering up to 5 outlet packs at the front and 5 at the rear

Pneumatic cloth seat.



# SPEED FOUR, SPEED FIVE AND POWERFIVE TRANSMISSIONS. THE RIGHT SPEED AT THE RIGHT MOMENT

Working in specialized crops means working with utmost precision.

The Rex series has been purposely conceived to respond to this specific need and a wide range of transmission configurations is now being offered to achieve this goal.

The Rex series comes with three different types of gearbox: a mechanical *TECHNO* version – *Speed Four* basic gearbox (with 4 speed ratios 12 FWD + 12 REV) with mechanical reverse shuttle; a *TOP* version with two different types of gearbox: a mechanical version with *Speed Five* (with 5 speed ratios 15 FWD + 15 REV) with mechanical reverse shuttle and the hydraulic *Powerfive* version (with 5 speed ratios 15 FWD + 15 REV + splitter gear with *Hi-Lo* electro-hydraulic engagement for 20% speed reduction to achieve 30 FWD + 30 REV speeds) with hydraulic reverse power shuttle.



## SPEED FIVE

THE SPEEDFIVE GEARBOX WITH FIVE SPEED GEARS USED WITH THE SYNCHRONIZED REVERSE SHUTTLE IS THE BASIC VERSION. IT FEATURES A MECHANICAL GEARBOX WITH FIVE SPEED RATIOS, ALL SYNCHRONIZED AND USED WITH THREE RANGES, SLOW, STANDARD AND FAST: 15 FORWARD SPEEDS + 15 REVERSE SPEEDS.

A CREEPER CAN BE APPLIED TO THE GEARBOX TO PROVIDE A FURTHER 5 ULTRA-SLOW FORWARD SPEEDS BEGINNING AT 0.32 KPH FOR A TOTAL OF 20 FORWARD SPEEDS.

THE SYNCHRONIZED REVERSE SHUTTLE ALLOWS THE OPERATOR TO MANOEUVRE QUICKLY AND SAFELY, FACILITATING HANDLING WORK OR WHEN FRONT LOADERS ARE USED: 20 FORWARD SPEEDS + 20 REVERSE SPEEDS. THE GEAR SEQUENCE COVERS A SPEED RANGE OF UP TO 40 KPH AND ALLOWS THE OPERATOR TO CHOOSE THE BEST SPEED IN ALL CONDITIONS.

THE TECHNO VERSION (SPEED FOUR) IS EQUIPPED WITH A GEARBOX OFFERING THE SAME FEATURES AS PROVIDED BY THE SPEED FIVE TRANSMISSION, BUT WITH ONE GEAR LESS AND A MAXIMUM SPEED OF 36 KPH., THE REX F MODEL COMES ALSO IN THE 2WD VERSION FOR A MAXIMUM SPEED OF 30 KPH WHATEVER THE TRANSMISSION CONFIGURATION MAY BE.

THE GEARBOX CONTROL LEVERS ARE INSTALLED IN A CONVENIENT AND ERGONOMIC POSITION. THEY ARE ARRANGED IN A COMFORTABLE WAY, ALLOWING THE TRACTOR TO BE EASILY AND SAFELY CONTROLLED THROUGHOUT ALL MANOEUVRES. THE GEARSHIFT LEVER (1) IS POSITIONED ON THE RIGHT-HAND SIDE OF THE DRIVER'S SEAT, ALLOWING THE FIVE GROUND SPEEDS TO BE IMMEDIATELY SELECTED. THE RANGE LEVER (2) FOR SELECTING THE SLOW, STANDARD, FAST AND CREEPER (IF FITTED) OPTIONS, IS INSTALLED ON THE LEFT-HAND SIDE OF THE DRIVING SEAT. THE REVERSE SHUTTLE LEVER (3) ON THE LEFT-HAND SIDE OF THE STEERING WHEEL, ALLOWS OPERATORS TO QUICKLY AND PRECISELY CHANGE DIRECTION. < FIG. A





## KEY FEATURES AND ADVANTAGES

- › POSSIBILITY OF CHOOSING EITHER MECHANICAL OR HYDRAULIC TRANSMISSIONS
- › WIDE CHOICE OF SPEEDS ON ALL MODELS. SPEED SELECTION POSSIBLE ACCORDING TO THE WORK TO BE PERFORMED
- › ELECTRO-HYDRAULIC REVERSE SHUTTLE WITH REMOTE CONTROL AT STEERING WHEEL
- › QUICK SPEED CHANGES AND CHANGES UNDER LOAD. CUT-DOWN OF WORKING TIMES.

## POWERFIVE

POWERFIVE IS A HI-LO ELECTRO-HYDRAULIC MODULE THAT ENGAGES ON LOAD AND THAT, WHEN USED WITH THE BASIC GEARBOX, REDUCES EACH INDIVIDUAL SPEED GEAR BY 20%, THUS DOUBLING THE NUMBER OF SPEEDS: 40 FWD + 40 REV (WITH CREEPER). POWERFIVE IS A "HALF-GEAR" THAT'S IDEAL WHEN OVERCOMING OBSTACLES OR WHEN DEALING WITH MOMENTARY OVERLOADS. IT'S OPERATED BY SIMPLY PRESSING ON THE GREEN PUSHBUTTON INTEGRATED IN THE GEARSHIFT LEVER (FIG B) WITHOUT USING THE CLUTCH PEDAL. THE POWERFIVE IS COMBINED WITH THE ELECTRO-HYDRAULIC POWERSHUTTLE, BEING CONTROLLED BY A LEVER LOCATED UNDER THE STEERING WHEEL TO THE LEFT OF THE DRIVING SEAT. [> FIG.B] WITH ELECTRO-HYDRAULICALLY CONTROLLED OIL-COOLED CLUTCH ASSEMBLY. THIS SYSTEM MAKES MANOEUVRING EASY AND SAFE WITHOUT HAVING TO STOP THE MACHINE OR USE THE CLUTCH PEDAL.

## DECLUTCH

THE DECLUTCH SYSTEM DISENGAGES THE MAIN CLUTCH BY MEANS OF THE ORANGE BUTTON [> FIG.B] INTEGRATED ON THE GEARSHIFT LEVER. THE BUTTON ALLOWS THE MECHANICAL GEARS OF THE GEARBOX TO BE CHANGED WITHOUT THE AID OF THE CLUTCH PEDAL. THE CLUTCH PEDAL IS USED ONLY FOR VERY PRECISE TRACTOR MANOEUVRES OR WHERE SPACE IS AT A PREMIUM SO AS TO ALLOW THE OPERATOR TO WORK WITH THE UTMOST SAFETY AND PRECISION, PARTICULARLY WHEN IMPLEMENTS ARE HITCHED/UNHITCHED.

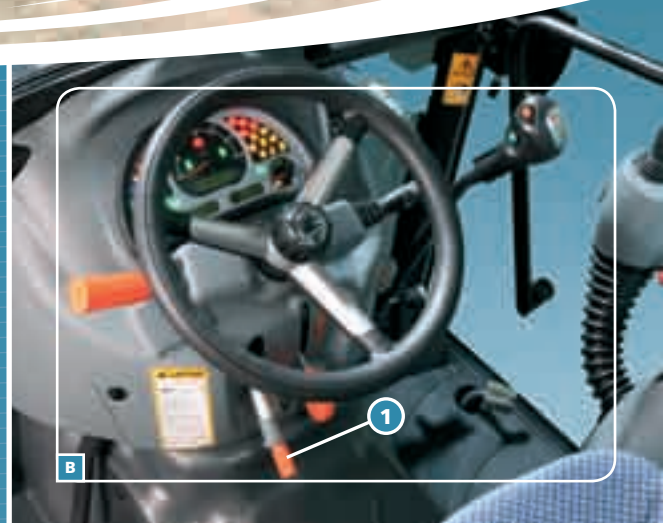

## PARK LOCK

THE PARK LOCK DEVICE IS CONTROLLED BY THE ORANGE LEVER (1) [> FIG.B] AND SHOULD BE ENGAGED WHEN THE TRACTOR IS PARKED ON SLOPING ROADS OR GROUND. IT MAKES SURE THAT THE TRANSMISSION REMAINS COMPLETELY BLOCKED.

## KEY FEATURES AND ADVANTAGES

- › HANDINESS AND AGILITY BETWEEN CROP ROWS
- › STEERING RADIUS REDUCED BY 20%
- › ELECTRO-HYDRAULICALLY CONTROLLED PUSHBUTTON ENGAGEMENT OF 4WD AND DIFFERENTIAL LOCK
- › IBS INTEGRAL BRAKING ON THE FOUR WHEELS



## FOUR WHEEL DRIVE AXLE

THE 4WD AXLES OF REX ORCHARD TRACTORS HAVE BEEN PURPOSELY AND SPECIFICALLY CONCEIVED FOR THIS PRODUCT RANGE.

THE REX SERIES OFFERS A CHOICE OF TWO DIFFERENT 4WD AXLES: ONE FOR F AND GE VERSIONS AND ONE FOR THE GT MODELS.

ALL VERSIONS WILL HOWEVER FIT TOUGH COMPACT SIZED AXLES ACCORDING TO TRACTOR TYPE WITH CENTRAL TRANSMISSION, "HYDRALOCK" TYPE DIFFERENTIAL LOCK, OIL-COOLED FRONT BRAKES AND E EPICYCLIC FINAL DRIVES.

THE FOUR-WHEEL DRIVE ENGAGEMENT/DISENGAGEMENT IS ELECTRO-HYDRAULICALLY CONTROLLED BY MEANS OF A BUTTON (1) [➤ FIG.B] ENSURING A PRECISE AND EFFORTLESS ENGAGEMENT.



## AGILITY AND SAFETY BETWEEN CROP ROWS

To overcome any sort of problem connected with the most different plantations typologies, the Rex series comes with three different types of transaxles, front and rear axles, wheel base and track dimensions and three models for an equal number of applications: the F model purposely designed for small sized and narrow orchards, the GE model ideal for low orchard crops and awning cultivations and the GT model, ideal for use in large-sized orchard plantations and open field work.

The high evolution degree achieved by this product range makes all models extremely handy and versatile.

A high ground clearance and the extremely tight steering radius allows these machines to deal with the most difficult jobs or where there is not much space for manoeuvring.

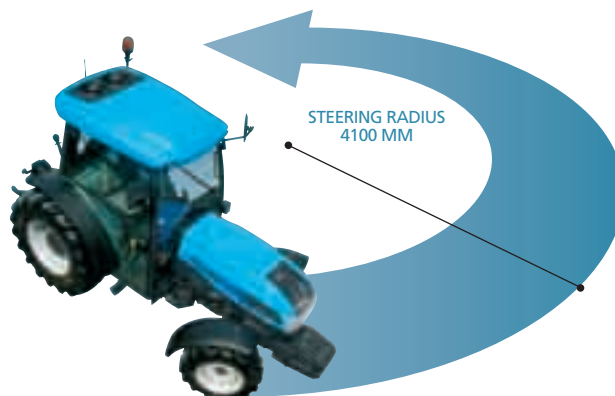

### IBS INTEGRAL BRAKING

THE IBS INTEGRAL BRAKING ON THE FOUR WHEELS, WITH CONTROL VALVE, ENSURES THAT THE SINGLE REAR WHEEL IS BRAKED IF ONLY ONE PEDAL IS DEPRESSED WHEN THE PEDALS ARE LATCHED TOGETHER DURING FIELD WORK, OR WHEN MANOEUVRING IN TIGHT CORNERS.

THE CONTROL VALVE GUARANTEES AN INTEGRAL BRAKING ACTION ON THE FOUR WHEELS WHEN THE PEDALS ARE LATCHED TOGETHER (FOR TRANSPORT PURPOSES OR WHEN DRIVING ON THE ROADS).

WITH THE "IBS" BRAKING SYSTEM, BRAKING DISTANCES ARE REDUCED BY 50%, THUS PROVIDING THE UTMOST SAFETY DURING ROAD CIRCULATION.

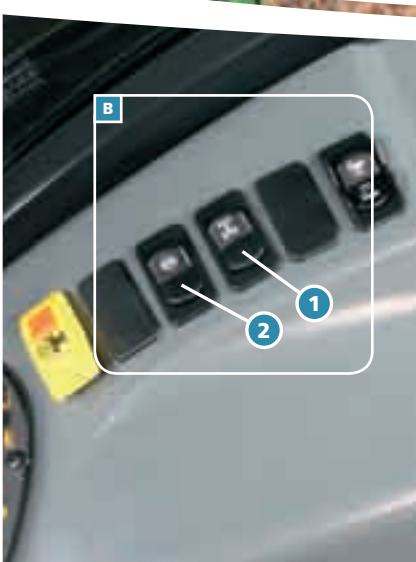

### TWIN-LOCK DIFFERENTIAL LOCK

SIMULTANEOUS ELECTRO-HYDRAULIC ENGAGEMENT OF THE FRONT AND REAR DIFFERENTIALS. THE TWIN-LOCK DIFFERENTIAL LOCKING SYSTEM HAS BEEN DESIGNED TO INTEGRATE WITH THE FOUR-WHEEL DRIVE SO AS TO PROVIDE THE MAXIMUM TRACTION POWER DURING OPEN FIELD WORK IN EXTREME CONDITIONS. COMBINED WITH AN OPTIMUM WEIGHT DISTRIBUTION, THIS LOCKING SYSTEM IMPROVES THE VEHICLE'S TRACTION CAPACITY, REDUCING WHEEL SLIPPAGE THUS GUARANTEEING GREATER PRODUCTIVITY. THE DIFFERENTIALS ARE LOCKED WHILST THE TRACTOR IS ON THE MOVE BY MEANS OF A KNOB (2) [> FIG.B] ON THE CONSOLE ON THE RIGHT-HAND SIDE OF THE DRIVER'S SEAT WHILE THEY ARE DISENGAGED BY LIGHTLY PRESSING ONE OR BOTH BRAKE PEDALS.

### THE UTMOST SAFETY DOWN SLOPES

WHEN INTEGRATED WITH HYDRAULIC TRAILER BRAKE (AVAILABLE ON REQUEST), THE "IBS" BRAKING SYSTEM PROVIDES THE MAXIMUM EFFICIENCY ON SLOPING ROADS, THUS ENSURING A BALANCED AND SIMULTANEOUS BRAKING ACTION FOR BOTH TRACTOR AND TRAILER.

# HIGH-PERFORMANCE HYDRAULIC CIRCUIT

The quality and versatility of *Rex* tractors mostly depend on their hydraulic circuit, decidedly performance-oriented and with a wealth of options. The standard *Rex* tractors come with two circuits. One supplies the steering system and the various electro-hydraulic controls (differential locks, four-wheel drive, *PTO* clutch, *Powershuttle*, *Powerfive* and forced lubrication of the gearbox) with a pump featuring a 29.9 l/min flow rate.

The other one supplies the power lift, the auxiliary hydraulic control valves and the hydraulic trailer brake with a pump featuring a 52.3 l/min flow rate. This solution allows the *Rex* series to become extremely versatile and productive, with pioneering features in the specialistic orchard tractor bracket.

But the true force of the new *Rex* stands in the wealth of options available, that make these tractors extremely versatile and suitable for use with any sort of front and rear implements.

Proof of this is that, thanks to the wealth of features available, the *Rex Top* version (*Synchro* and *Power Shuttle*) can provide as many as 5 rear and front hydraulic outlet packs.

A true hydraulic power station capable of actually controlling any work situation in specialized crops worldwide.



## REAR AND FRONT SPLIT HYDRAULIC TAPS

THE SPLITTING OF THE REAR CONTROL VALVES PIPING OUTLETS (OPTIONAL FOR THE SYNCHRO AND POWER SHUTTLE TOP VERSIONS) PROVIDES A DOUBLE NUMBER OF HYDRAULIC TAPS BOTH AT THE FRONT AND AT THE REAR. [FIG. B], WITHOUT THE NEED OF A DEDICATED HYDRAULIC CONTROL VALVE.

## 3 WAYS FLOW DIVIDER

THE OPTIONAL 3-WAYS ELECTRO-HYDRAULIC FLOW DIVIDER, AVAILABLE FOR ALL TOP VERSIONS (SYNCHRO AND POWER SHUTTLE) AND TECHNO (F/GE), PROVIDES AS MANY AS 3 OUTLET COUPLES.

THANKS TO THIS SYSTEM IT IS POSSIBLE TO KEEP BOTH HYDRAULIC LEVELLING RAM AND HYDRAULIC TOP LINK ENGAGED WHILE DISPOSING AT THE SAME TIME OF A COUPLE OF FREE COUPLERS. BOTH OPERATIONS

ARE CONTROLLED BY SIMPLY ACTIVATING THE RELEVANT KNOBS INTEGRATED IN A MECHANICAL LEVER (1). > FIG. A

## FRONT CONTROL VALVES WITH TRIPLE PUMP

THE VERSIONS WITH TRIPLE PUMP, AVAILABLE ON REQUEST ON THE REX TOP VERSIONS (SYNCHRO AND POWER SHUTTLE), COME WITH 3 FRONT CONTROL VALVES, EACH ONE OF THEM EQUIPPED WITH FLOW DIVIDER. TWO CONTROL VALVES ARE CONTROLLED BY THE JOYSTICK (2) [< FIG. A] – WHILST THE THIRD ONE IS ACTIVATED BY THE “ON/OFF” SWITCH (3) [FIG. A] POSITIONED ON THE R.H. CONSOLE.

THE VERSION WITH DOUBLE PUMP COMES WITH JUST ONE FRONT CONTROL VALVE FOR HYDRAULIC MOTOR AND FLOW DIVIDER BEING CONTROLLED BY THE ON/OFF SWITCH.

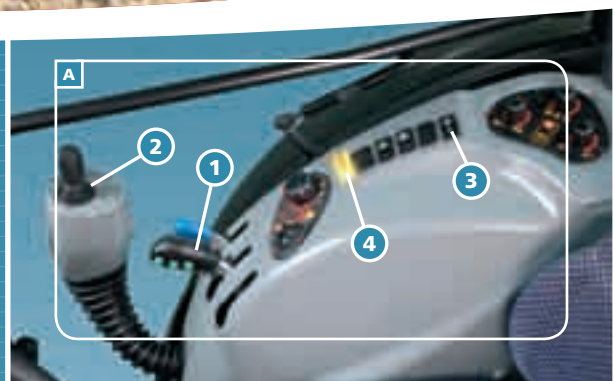





## KEY FEATURES AND ADVANTAGES

- › EXTREMELY ACCURATE HYDRAULIC SYSTEM
- › A WEALTH OF HYDRAULIC OPTIONS AVAILABLE
- › MORE ACCURATE ADJUSTMENT OF POWER LIFT SENSITIVITY
- › SMOOTH AND PROGRESSIVE ENGAGEMENT OF THE ELECTRO-HYDRAULICALLY CONTROLLED PTO FOR ENHANCED EFFICIENCY, UTMOST SAFETY AND INCREASED PRODUCTIVITY

### ELECTRONIC POWER LIFT WITH ENHANCED SENSITIVITY

THE ELECTRONIC POWER LIFT, AVAILABLE ON ALL CAB TOP VERSIONS AND WITH ALL CONTROLS ERGONOMICALLY ARRANGED ON THE CONSOLE AT THE OPERATOR'S R.H. SIDE [FIG. A], PROVIDES A MORE ACCURATE CONTROL OVER THE IMPLEMENTS THANKS TO THE BASIC DRAFT, POSITION AND INTERMIX FUNCTIONS. THE DRAFT SENSOR IS INSTALLED STRAIGHT ON THE THIRD POINT OF THREE-POINT HITCH WHERE THE SENSITIVITY IS AT ITS MAXIMUM LEVELS IN DIRECT CONTACT WITH THE LINK ONTO WHICH THE FORCES THAT STRESS THE IMPLEMENT AT WORK ARE. THE POSITION SENSOR IS INSTALLED IN CONTACT WITH A CAM ON THE POWER LIFT'S SHAFT. THESE SENSORS TRANSMIT SIGNALS TO A CONTROL UNIT WHICH PROCESSES THEM TO SUIT THE ADJUSTMENTS MADE ON THE OPERATOR'S CONSOLE THUS ENSURING THE UTMOST IN PERFORMANCE FROM THE TRACTOR/IMPLEMENT COMBINATION AND PROVIDING BETTER TRACTION AND INFINITELY REGULAR GROUND SPEED WITH HIGH PRODUCTIVITY AND EFFICIENCY. THE CAT 2. THREE POINT LINKAGE CAN BE OPTIONALLY EQUIPPED

WITH THIRD POINT AND HYDRAULIC LEVELLING RAM. > FIG. C

AN HYDRAULIC POWER LIFT COMES AS STANDARD WITH MECHANICAL CONTROLS INSTALLED ON THE RIGHT HAND SIDE OF THE DRIVER'S SEAT FOR ACCURATE IMPLEMENT OPERATION. > FIG. D

### POWER TAKE-OFF

THE REX SERIES COMES WITH A MECHANICALLY OPERATED PTO FOR THE TECHNO VERSION (SYNCHRO SHUTTLE), WHILE FOR THE TOP VERSION (POWER SHUTTLE) THE PTO IS ELECTRO-HYDRAULICALLY OPERATED. BOTH VERSIONS ARE AVAILABLE WITH TWO BASIC SPEEDS: 540/750 OR 540/1000 RPM. < FIG. C THE 540/1000 VERSION IS EQUIPPED WITH A SPECIFIC BRAKE, INTEGRATED INTO THE CLUTCH, WHICH AUTOMATICALLY SETS INTO OPERATION WHEN THE PTO IS DISENGAGED SO AS TO AVOID A CONTINUOUS IDLING OF THE CARDAN SHAFT CONNECTED TO THE IMPLEMENT. THE PUSH BUTTON (4) [FIG. A] CONTROLLING THE OIL-BATH DISC CLUTCH ENABLES SMOOTH AND PROGRESSIVE ENGAGEMENT OF THE PTO, PREVENTING ABRUPT STARTING OF THE SHAFT FOR MAXIMUM COMFORT AND SAFE IMPLEMENT OPERATION.

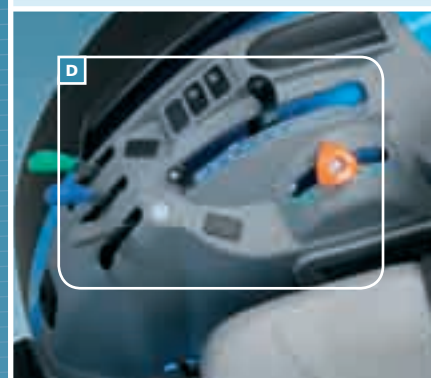



		REX 70 F-GE		REX 80 F-GE-GT		REX 85 F-GE		REX 90 F-GE-GT		REX 100 F-GE-GT		REX 110 F-GE-GT		REX 120 F-GE-GT	
		SYNCHRO	POWER	SYNCHRO	POWER	SYNCHRO	POWER	SYNCHRO	POWER	SYNCHRO	POWER	SYNCHRO	POWER	SYNCHRO	POWER
		SHUTTLE	SHUTTLE	SHUTTLE	SHUTTLE	SHUTTLE	SHUTTLE	SHUTTLE	SHUTTLE	SHUTTLE	SHUTTLE	SHUTTLE	SHUTTLE	SHUTTLE	SHUTTLE
<b>ENGINE</b>															
PERKINS TIER 3 DIRECT-INJECTION ENGINE		1103D-33TA	1104D-44	1103D-33TA	1104D-44T	1104D-44TA	1104D-44TA	1104D-44TA	1104D-44TA	1104D-44TA	1104D-44TA	1104D-44TA	1104D-44TA	1104D-44TA	1104D-44TA
MAX. POWER (ISO)	HP/KW	68/50	74/54,5	79/58	83/61	92,5/68	102/75	110,2/81							
RATED SPEED	RPM	2200	2200	2200	2200	2200	2200	2200							
MAX. TORQUE	NM	280	261	310	352	393	416	410							
MAX. TORQUE SPEED	RPM	1400	1400	1400	1400	1400	1400	1400							
BORE/STROKE	MM	105/127	105/127	105/127	105/127	105/127	105/127	105/127							
NR. OF CYLINDERS / TURBOCHARGED		3300/3	4400/4	3300/3	4400/4	4400/4	4400/4	4400/4							
COMPRESSION RATIO		18,2:1	18,2:1	18,2:1	18,2:1	18,2:1	18,2:1	18,2:1							
WATER COOLING		●	●	●	●	●	●	●							
AIR FILTER		●	●	●	●	●	●	●							
FUEL TANK CAPACITY F-GE	LT.	40 + (25 opt)	40 + (25 opt)	40 + (25 opt)	65	65	65	65							
FUEL TANK CAPACITY GT	LT.	-	57 + (25 opt)	-	82	82	82	82							
<b>CLUTCH</b>															
INDEPENDENT DRY DUAL CLUTCH	IN.	11	12	11	12	12	12	12							
MECHANICALLY OPERATED		●	●	●	●	●	●	●							
MULTI-DISC WET CLUTCH		●	●	●	●	●	●	●							
DE-CLUTCH CONTROL: CLUTCH CONTROL BY BUTTON		●	●	●	●	●	●	●							
<b>TRANSMISSION</b>															
SPEED FOUR+MECH. REV. SHUTTLE: 12FWD+12REV		TECHNO AND 2WD* VERS.	TECHNO AND 2WD* VERS.	TECHNO AND 2WD* VERS.	TECHNO AND 2WD* VERS.	2WD* VERS.	2WD* VERS.	2WD* VERS.							
SPEED FOUR+CREEPER+MECH.REV. SHUTTLE: 16FWD+16REV		TECHNO AND 2WD* VERS.	TECHNO AND 2WD* VERS.	TECHNO AND 2WD* VERS.	TECHNO AND 2WD* VERS.	2WD* VERS.	2WD* VERS.	2WD* VERS.							
POWER FOUR + INVERS. HYDRAULIC: 24FWD+24REV		2WD* VERS.	2WD* VERS.	2WD* VERS.	2WD* VERS.	2WD* VERS.	2WD* VERS.	2WD* VERS.							
POWER FOUR + SUPERID. + INVERS. HYDRAULIC: 32FWD+32REV		2WD* VERS.	2WD* VERS.	2WD* VERS.	2WD* VERS.	2WD* VERS.	2WD* VERS.	2WD* VERS.							
REAR ELECTROHYDRAULIC DIFF-LOCKSE		TECHNO AND 2WD* VERS.	TECHNO AND 2WD* VERS.	TECHNO AND 2WD* VERS.	TECHNO AND 2WD* VERS.	2WD* VERS.	2WD* VERS.	2WD* VERS.							
SPEED FIVE + INVERS. MECH.: 15FWD+15REV		●	●	●	●	●	●	●							
SPEED FIVE + SUPERID. + INVERS. MECH.: 20FWD+20REV		○	○	○	○	○	○	○							
POWER FIVE + SPEED FIVE 30FWD+30REV		○	○	○	○	○	○	○							
POWER FIVE + SPEED FIVE + SUPERIDUTTORE 40FWD+40REV		○	○	○	○	○	○	○							
REVERSE POWER SHUTTLE: UNDER LOAD		●	●	●	●	●	●	●							
<b>POWER TAKE-OFF</b>															
POWER-ASSISTED MECHANICAL ENGAGEMENT		●	●	●	●	●	●	●							
OIL-IMMERSED MULTI-DISK HYDRA P.T.O.		●	●	●	●	●	●	●							
ELECTROHYDRAULIC ENGAGEMENT		●	●	●	●	●	●	●							
2 SPEEDS 540/750 RPM		●	●	●	●	●	●	●							
2 SPEEDS 540/1000 RPM		○	○	○	○	○	○	○							
1" 3/8 (34,9 MM) PTO SHAFT WITH 6 SPLINES		●	●	●	●	●	●	●							
GROUND SPEED PTO		○	○	○	○	○	○	○							
NET PTO POWER (ISO)	HP/KW	58/42,5	63/46,5	68/50	70,5/51,5	79/58	86,5/63,5	92,5/68							
<b>4WD FRONT AXLE</b>															
DOUBLE-ACTING DIRECTION CYLINDER		●	●	●	●	●	●	●							
EPICYCLIC FINAL DRIVES		●	●	●	●	●	●	●							
ELECTROHYDRAULIC 4WD ENGAGEMENT		●	●	●	●	●	●	●							
MAX. STEERING ANGLE		55	55	55	55	55	55	55							
TWIN-LOCK ELECTROHYDRAULIC DIFF-LOCKS		●	●	●	●	●	●	●							
LIMITED SLIP DIFF-LOCKS		TECHNO VERS.	TECHNO VERS.	TECHNO VERS.	TECHNO VERS.	-	-	-							
<b>BRAKES</b>															
HYDROSTATIC CONTROL		●	●	●	●	●	●	●							
OIL-IMMERSED GRAPHITE-COATED REAR BRAKES, 8 DISCS		●	●	●	●	●	●	●							
OIL-IMMERSED GRAPHITE-COATED FRONT BRAKES, 4 DISCS		●	●	●	●	●	●	●							
IBS INTEGRAL BRAKING SYSTEM		●	●	●	●	●	●	●							
4 WD AUTOMATIC ENGAGEMENT ON BRAKING		TECHNO VERS.	TECHNO VERS.	TECHNO VERS.	TECHNO VERS.	-	-	-							
<b>HYDRAULIC POWER LIFT</b>															
DRAFT, POSITION, INTERMIX AND FLOATING CONTROL FUNCTIONS		●	●	●	●	●	●	●							
MECHANICALLY OPERATED		●	●	●	●	●	●	●							
"LANDTRONIC" ELECTRONIC POWER LIFT (ONLY CAB VERSION)		○	○	○	○	○	○	○							
STANDARD LIFTING CAPACITY	KG	2600	2600	2600	2600	2600	2600	2600							
ADDITIONAL CAPACITY WITH 1 AUXIL. CYLINDER (ONLY FOR GT MOD.)	KG	-	+ 650	-	+ 650	+ 650	+ 650	+ 650							
HYDRAULIC FLOW @ REMOTE (POWER LIFT+ STEERING)	LT/MIN	52,3+29,9	52,3+29,9	52,3+29,9	52,3+29,9	52,3+29,9	52,3+29,9	52,3+29,9							
CAT. 2 THREE-POINT LINKAGE		●	●	●	●	●	●	●							
HYDRAULIC ADJUSTMENT OF RIGHT LIFTING ROD		●	●	●	●	●	●	●							
AUXILIARY VALVES STD F/GE/GT	N°	2 / 2	2 / 2 / 3	2 / 2	2 / 2 / 3	2 / 2 / 3	2 / 2 / 3	2 / 2 / 3							
FLOW DIVIDER		○	○	○	○	○	○	○							
TRIPLE PUMP HYDRAULIC FLOW (POWER LIFT+STEERING+AUX.VALVES)		41+29+41	41+29+41	41+29+41	41+29+41	41+29+41	41+29+41	41+29+41							
TRIPLE PUMP + 3 FRONT AUX. VALVES + JOYSTICK		○	○	○	○	○	○	○							
<b>CAB AND DRIVING SEAT</b>															
REX TOTAL VIEW / AUTO-RADIO FITTING FACILITIES		●	●	●	●	●	●	●							
HEATING / VENTILATION		●	●	●	●	●	●	●							
AIR-CONDITIONING		●	●	●	●	●	●	●							
OPENABLE REAR AND FRONT DOORS		●	●	●	●	●	●	●							
SUSPENDED PLATFORM		●	●	●	●	●	●	●							
DIGITAL INSTRUMENTS		●	●	●	●	●	●	●							
<b>OPTIONAL EQUIPMENT</b>															
6 FRONT WEIGHTS 79.2 LB. (36 KG) EACH		○	○	○	○	○	○	○							
4 REAR WEIGHTS 99 LB. (45 KG) EACH		○	○	○	○	○	○	○							
HYDRAULIC TRAILER BRAKES		○	○	○	○	○	○	○							

Key: ● standard ○ option - not available  
\* 2WD version available only for Rex F model

N.B.: all other data not included in this table are the same for both the TECHNO and SYNCHRO SHUTTLE versions of the 70, 80, 85 and 90 F, GE and GT models.  
The TECHNO versions of the 100, 110 and 120 F, GE and GT models are not included in the price list.

**DIMENSIONS AND WEIGHTS**

	F	GE	F	GE	GT	F	GE	F	GE	GT	F	GE	GT	F	GE	GT	F	GE	GT
	28070R16	26070R16	28070R16	26070R16	28070R18	28070R16	26070R16	28070R16	26070R16	28070R18	28070R16	26070R16	28070R18	28070R16	26070R16	28070R18	28070R16	26070R16	28070R18
FRONT TYRES 4RM	14.9R24	14.9LR20	14.9R24	14.9LR20	14.9R24	14.9R24	14.9LR20	14.9R24	14.9LR20	14.9R24	14.9R24	14.9LR20	14.9R24	14.9R24	14.9LR20	14.9R24	14.9R24	14.9LR20	14.9R24
REAR TYRES	14.9R24	14.9LR20	14.9R24	14.9LR20	14.9R24	14.9R24	14.9LR20	14.9R24	14.9LR20	14.9R24	14.9R24	14.9LR20	14.9R24	14.9R24	14.9LR20	14.9R24	14.9R24	14.9LR20	14.9R24
A - MIN. LENGTH 2RM E 4RM	MM	3900	3900	4009	4009	4009	3900	3900	4009	4009	4009	4009	4009	4009	4009	4009	4009	4009	4009
B - MIN. WIDTH	MM	1437	1413	1437	1413	1554	1437	1413	1437	1413	1554	1437	1413	1554	1437	1413	1554	1437	1413
C - WHEELBASE 2RM	MM	2065	—	2174	—	—	2065	—	2174	—	—	2174	—	—	2174	—	—	2174	—
C - WHEELBASE 4RM	MM	2017	2017	2134	2134	2134	2017	2017	2134	2134	2134	2134	2134	2134	2134	2134	2134	2134	2134
D - AHEIGHT TO STEERING WHEEL	MM	1440	1300	1440	1300	1440	1440	1300	1440	1300	1440	1440	1300	1440	1440	1300	1440	1440	1300
E - HEIGHT TO SAFETY FRAME	MM	2315	2150	2315	2150	2315	2315	2150	2315	2150	2315	2315	2150	2315	2315	2150	2315	2315	2150
F - HEIGHT OVER CAB	MM	2260	—	2260	—	2260	2260	—	2260	—	2260	2260	—	2260	—	2260	—	2260	—
F - GROUND CLEARANCE 4RM	MM	220	190	220	190	240	220	190	220	190	240	220	190	240	220	190	240	220	190
WEIGHT 2WD (WITHOUT BALLAST) + (130 KG CAB)	KG	2500	—	2615	—	—	2500	—	2615	—	—	2615	—	—	2615	—	—	2615	—
WEIGHT 4WD (WITHOUT BALLAST) + (130 KG CAB)	KG	2675	2480	2845	2540	2865	2675	2480	2845	2540	2865	2845	2540	2865	2845	2540	2865	2845	2540
FRONT TRACKS MIN 4WD	MM	1155	1155	1155	1155	1272	1155	1155	1155	1155	1272	1155	1155	1272	1155	1155	1272	1155	1155
FRONT TRACKS MAX 4WD	MM	1422	1423	1422	1423	1628	1422	1423	1422	1423	1628	1422	1423	1628	1422	1423	1628	1422	1423
REAR TRACKS MIN 4WD	MM	992	989	992	989	1064	992	989	992	989	1064	992	989	1064	992	989	1064	992	989
REAR TRACKS MAX 4WD	MM	1415	1301	1415	1301	1489	1415	1301	1415	1301	1489	1415	1301	1489	1415	1301	1489	1415	1301

**THE RIGHT SPEED FOR EVERY APPLICATION**

(THE DATA SHOWN IN THE TABLE REFER TO THE REX F 4WD MODEL)

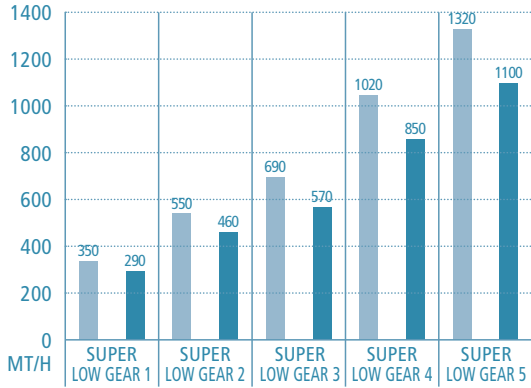

SPEEDS WITH POWERFIVE TRANSMISSION AND CREEP FACILITY IN M/HR WITH 14.9R24 OR 420/70-R-24 OR 360/70-R-28 OR 12.4-R-28 REAR TYRES. ENGINE RATED SPEED 2200 RPM.

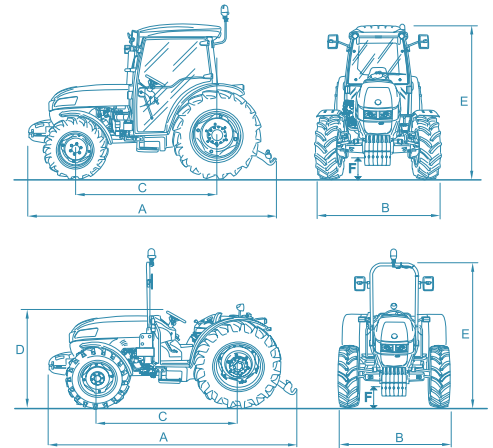

SPEEDS WITH 40 KM/H POWERFIVE TRANSMISSION AND 14.9R24 OR 420/70-R-24 OR 360/70-R-28 OR 12.4-R-28 REAR TYRES. ENGINE RATED SPEED 2200 RPM.

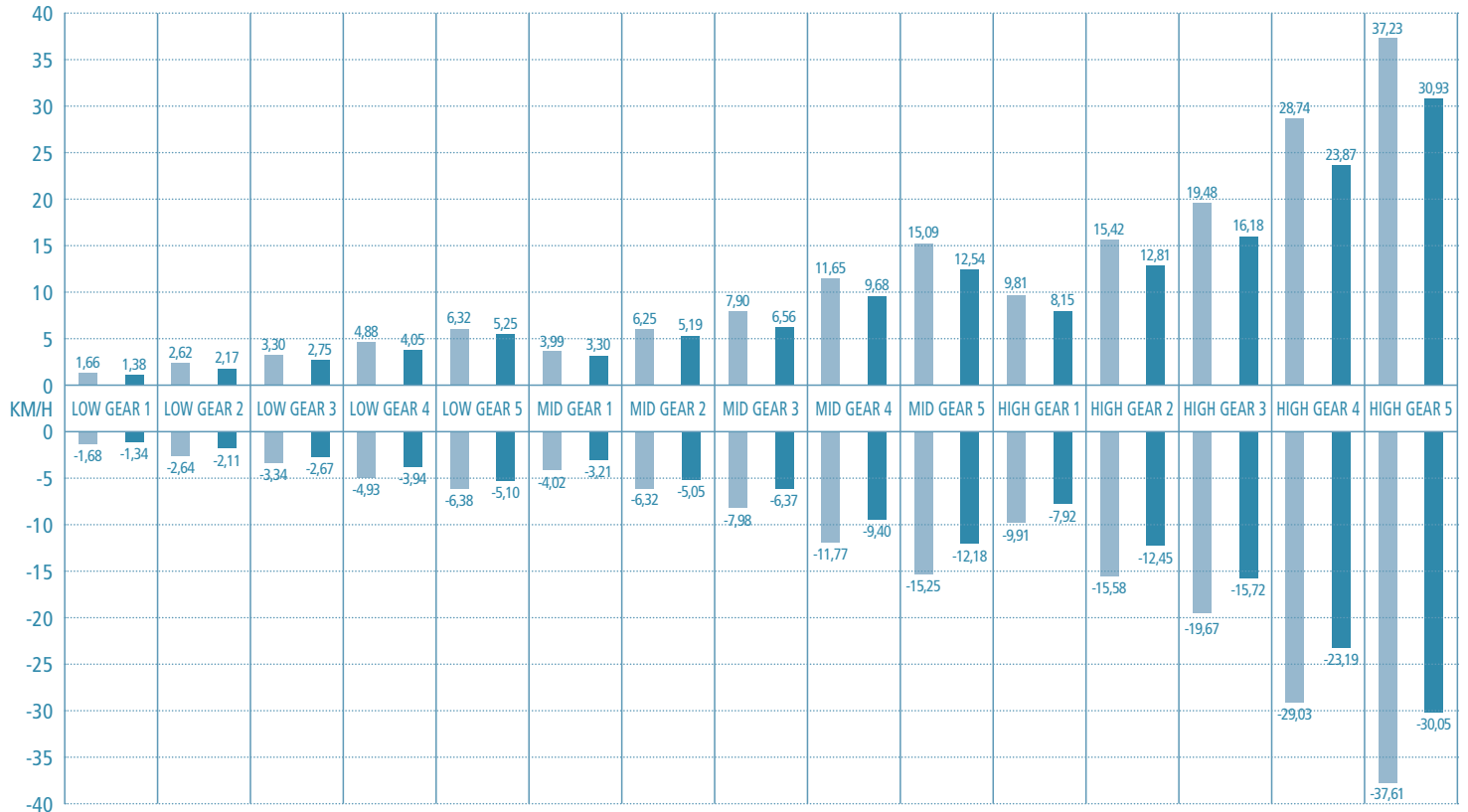

**POWERFIVE OR HYDRAULIC SPLITTER GEAR**  
(HI-LO, 20% SPEED REDUCTION)

■ NORMAL ■ POWERFIVE (HI-LO)

**Landini**®

Landini is a trademark of Argo Tractors S.p.A.  
via G. Matteotti, 7 | 42042 Fabbrico [RE] Italia  
t. +39.0522.656.111 | f. +39.0522.656.476  
webmaster@argotracors.com  
www.argotracors.com

